



METRIE™

—
THE ART OF FORM
SINCE 1926

MIDWEST – CHICAGO 2015-2016



THE
Art of
FORM



Since our beginnings as a small family-owned business in 1926, our dedication to creating high-quality, finely crafted architectural elements has helped us grow to become the largest supplier and manufacturer of solid wood and composite moulding in North America. Through our seven domestic manufacturing facilities, 26 distribution centers and global supply network, Metrie™ offers everything you need to set the stage for your space and your project's success.



Finish Before You Start™

Interior Finishings are decorative interior products that create the look, feel and flow of design throughout your home. They include trim, interior doors, wall treatments, ceiling treatments and mantels – all of which significantly impact the overall impression of a room or space. Select your finishings early in the design or renovation process for a professional designer look in your home. In other words, finish before you start.

TABLE of Contents

CHAPTER I	INTRODUCTION TO THEN & NOW FINISHING COLLECTIONS™	06
CHAPTER II	FASHION FORWARD COLLECTION	08
CHAPTER III	FRENCH CURVES COLLECTION	18
CHAPTER IV	PRETTY SIMPLE COLLECTION	28
CHAPTER V	TRUE CRAFT COLLECTION	36
CHAPTER VI	VERY SQUARE COLLECTION	48
CHAPTER VII	REGIONAL PRODUCTS	58

THIS IS then & NOW

Then & Now Finishing Collections™ offer professionally designed and perfectly coordinated trim and interior doors to suit a wide range of decor styles that take the guesswork out of selecting interior finishings. Each Collection is inspired by a different architectural style and includes everything from crowns to baseboards and architraves to unique Ikon™ rosettes. Every element is made from premium-quality materials to create a professional look every time. So you can open the door to a whole new world of inspiration, crafted piece by piece for an exquisite, lasting impression.

you CHOOSE the SCENE

Each Finishing Collection contains a series of coordinating moulding profiles called Scenes. The Scenes range in wood species, size and design to allow flexibility in creating a unique space within a particular Collection style.





FASHION FORWARD



COLOR AND LINES

Fashion Forward panel moulding profiles create modern linear movements through this space, while white and gray colors work to create a simply sophisticated look. The bright accent of gold paint on the custom mirror frame and Ikons™ adds a focal element to the room that is sure to capture attention.

WOOD AND STAIN

The Poplar grain and painted MDF elevate the classic yet playful shapes of Fashion Forward mouldings to create the traditional elegance of this room with a modern twist. Finishing the MDF pieces in a uniform tone, like the gray on gray seen here, evokes a look that is ready for next year's hottest trend.



A PERFECT FIT

Each moulding profile within the Fashion Forward Collection has been meticulously designed, so that they meet with a precise and proportioned fit, helping you achieve a designer look and professional result every time.



FASHION FORWARD™

We've taken classic elements and added a twist to each one. Simple, but sophisticated. Classic, but playful. You can make this Collection speak to so many styles. Go with rich sienna brown stains and create a Bistro feel. Evoke a Retro look by finishing the elements with high-contrast primary tones. Each of the three Scenes in this Collection is transitional, melding traditional and modern – leaving enough room for next year's hottest trend.

For this room, designer **Sophie Burke** took the transitional style of Fashion Forward Scene II elements and added Scene III panel moulding (below the chair rail) for a decidedly Urban look.

FASHION FORWARD™

doors

Fashion Forward interior doors have been designed to coordinate with all three trim Scenes, and are available in both solid core and glass options. All of these door designs feature concave shapes that echo the subtle sophistication of the Collection. The patterned glass door also carries the style of the Collection with the exclusive Nano pattern.



CLEAR GLASS DOOR



NANO PATTERNED GLASS DOOR



SOLID DOOR MDF

Features

FASHION FORWARD DOORS

Panel Doors 1 3/8" Thick

Width	16"	18"	20"	22"	24"	26"	28"	30"	32"	34"	36"
Height	80"	•	•	•	•	•	•	•	•	•	•
	84"		•			•	•	•	•	•	•
	96"		•			•	•	•	•	•	•

Glass Doors 1 3/8" Thick

Width	24"	28"	30"	32"	36"						
Height	80"	•	•	•	•						
	84"	•	•	•	•						
	96"	•	•	•	•						

Premium solid core and glass doors are pre-hung on double-rabbeted jambs in Finger Joint Pine, Poplar or White Oak. Double doors do not arrive pre-hung; some assembly required.

Choice of four hinge finishes: Oil-Rubbed Bronze, Polished Chrome, Antique Brass and Satin Nickel.

- A solid MDF core for a quality feel that resists warping and reduces sound transmission room to room
- MDF-router carved, primed and ready for painting
- Proprietary sticking on the door carving that echoes the lines in the Collection
- Glass doors are available in clear or textured, tempered glass, ensuring user safety
- Available pre-hung for easy installation and proper alignment in the frame
- Ball bearing hinges for smooth operation
- Double-rabbeted jamb available in 4 9/16" and 6 9/16"
- All doors can be special ordered as 20-minute fire-rated with 1 3/4" depth. Ask your supplier for more special order options.



Fashion Forward moulding and trim elements within Scene III provide a design palette with larger profiles and more intricate architectural detail.

Scene III



CFFROSPOP | IKON
4" x 4"
6" x 6"

This Fashion Forward Ikon™ was finished in silver metallic paint, and then polished to create a realistic looking metallic shine. This contemporary treatment would be a beautiful component in a mirror or artwork frame. It could also accent the hardware on doors and other metal elements in the room. All Ikon's are sold in Poplar.

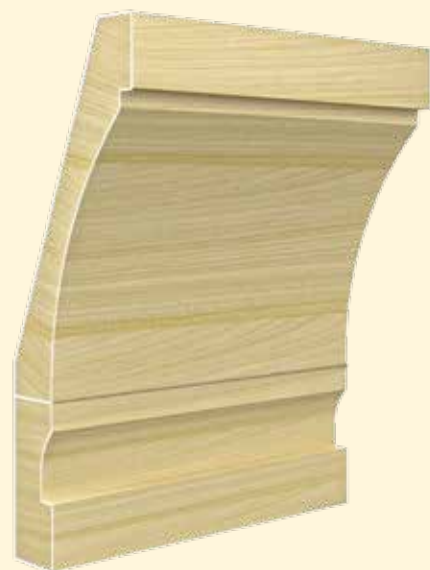

CFF3W2SPO | POPLAR | CROWN
2 3/4" x 8"
(INSTALLED DIMENSIONS)



CFF3C1SPO | POPLAR | CASING
1 1/16" x 4"



CFF3L1SPO | POPLAR | CHAIR RAIL
1" x 4"

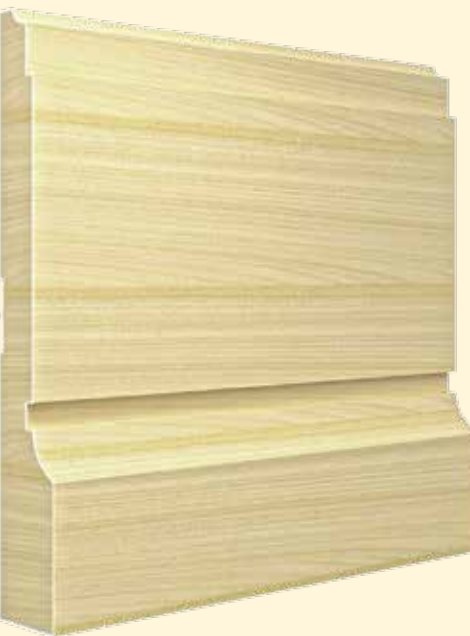

CFF3B2SPO | POPLAR | BASEBOARD
1" x 9"



CFF3P1SPO | POPLAR | PANEL MOULD
1" x 2"



CFF3A1SPO | POPLAR | ARCHITRAVE
1 3/4" x 8"

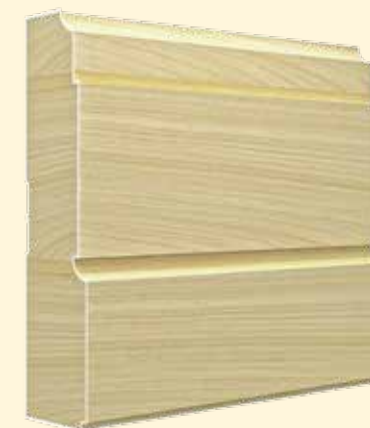

CFF3C2SPO | POPLAR | CASING
1 1/2" x 6"



CFF3B1SPO | POPLAR | BASEBOARD
3/4" x 6"



CFF3W1SPO | POPLAR | CROWN
1 1/16" x 6"

The solid engineered Poplar of these mouldings has beautiful, crisp grain lines that take rich tones of stains or paints to create a more modern look. The chic lines and concave cutouts of these elements blend the traditional and contemporary to create trendsetting accents.

Scene III

SCENE III

ITEM NUMBER	DIMENSIONS	LENGTHS
CFFROSPOP IKON	4" x 4", 1 1/4" Thick 6" x 6", 1" Thick	N/A
CFF3W2SPO CROWN	2 3/4" x 8"	Random

ITEM NUMBER	DIMENSIONS	LENGTHS
CFF3C1SPO CASING	1 1/16" x 4"	Random
CFF3L1SPO CHAIR RAIL	1" x 4"	Random

SCENE III

ITEM NUMBER	DIMENSIONS	LENGTHS
CFF3B2SPO BASEBOARD	1" x 9"	Random
CFF3P1SPO PANEL MOULD	1" x 2"	Random
CFF3A1SPO ARCHITRAVE	1 3/4" x 8"	Random

ITEM NUMBER	DIMENSIONS	LENGTHS
CFF3C2SPO CASING	1 1/2" x 6"	Random
CFF3B1SPO BASEBOARD	3/4" x 6"	Random
CFF3W1SPO CROWN	1 1/16" x 6"	Random

Images do not reflect actual product size.

Fashion Forward Scene II gives you greater creative license with the addition of architraves and chair rails, both of which add grandeur and impact to any space.

Scene II

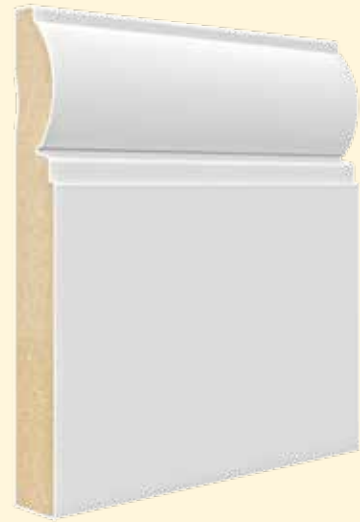

CFF2B2PMD | MDF | BASEBOARD
3/4" x 7 1/4"

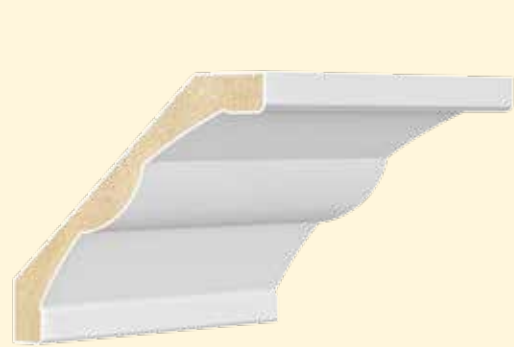

CFF2W1PMD | MDF | CROWN
1" x 5 11/16"

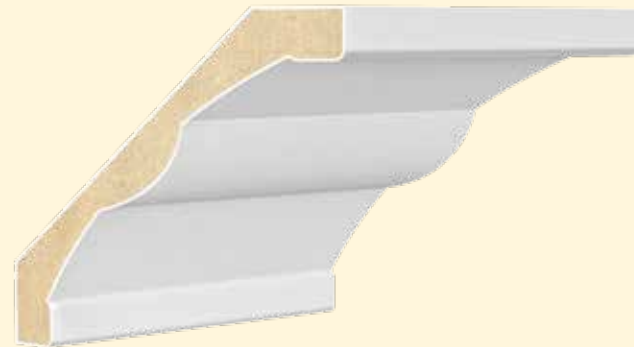

CFF2W2PMD | MDF | CROWN
1 1/4" x 7 1/8"



CFF2B1PMD | MDF | BASEBOARD
3/4" x 5 1/2"



CFF2A1PMD | MDF | ARCHITRAVE
1 1/2" x 3 1/2"



CFF2P1PMD | MDF | PANEL MOULD
1/2" x 1 1/8"



CFF2L1PMD | MDF | CHAIR RAIL
3/4" x 4"



CFF2C1PMD | MDF | CASING
1" x 3 1/2"



CFF2C2PMD | MDF | CASING
1" x 4 1/4"

These paint-grade MDF mouldings showcase exaggerated convex lines to create a pronounced look and presence that gives more of a nod to its classical side. A dark tone of paint can give this Scene more of a Bistro feel.

Scene II

SCENE II

ITEM NUMBER	DIMENSIONS	LENGTHS
CFF2B2PMD BASEBOARD	3/4" x 7 1/4"	8', 12', 16'

ITEM NUMBER	DIMENSIONS	LENGTHS
CFF2W1PMD CROWN	1" x 5 11/16"	8', 12', 16'
CFF2W2PMD CROWN	1 1/4" x 7 1/8"	8', 12', 16'

SCENE II

ITEM NUMBER	DIMENSIONS	LENGTHS
CFF2B1PMD BASEBOARD	3/4" x 5 1/2"	8', 12', 16'
CFF2A1PMD ARCHITRAVE	1 1/2" x 3 1/2"	8', 12'
CFF2P1PMD PANEL MOULD	1/2" x 1 1/8"	8', 12'

ITEM NUMBER	DIMENSIONS	LENGTHS
CFF2L1PMD CHAIR RAIL	3/4" x 4"	8', 12'
CFF2C2PMD CASING	1" x 4 1/4"	8', 12'
CFF2C1PMD CASING	1" x 3 1/2"	8', 12'

Images do not reflect actual product size.

Fashion Forward Scene I lets you finish a room with solid foundational essentials like crowns, casings and baseboards.

Scene I



CFF1B2PMD | MDF | BASEBOARD
5/8" x 5 1/2"



CFF1B1PMD | MDF | BASEBOARD
5/8" x 4 1/4"



CFF1C1PMD | MDF | CASING
3/4" x 2 3/4"



CFF1W1PMD | MDF | CROWN
3/4" x 4 1/4"

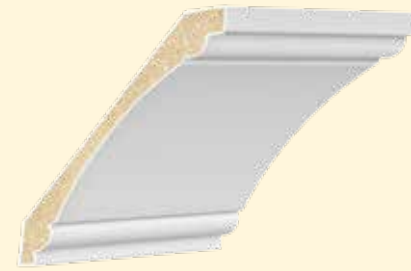

CFF1W2PMD | MDF | CROWN
3/4" x 5 1/4"



CFF1C2PMD | MDF | CASING
3/4" x 3 1/2"

Simple convex lines make the crown mouldings in Scene I much more subtle than the previous two Scenes. They also incorporate details at the ends of the profiles to create that classic elegance while maintaining a modern twist.

Scene I

SCENE I

ITEM NUMBER	DIMENSIONS	LENGTHS
CFF1B2PMD BASEBOARD	5/8" x 5 1/2"	8', 12', 16'
CFF1B1PMD BASEBOARD	5/8" x 4 1/4"	8', 12', 16'

ITEM NUMBER	DIMENSIONS	LENGTHS
CFF1C1PMD CASING	3/4" x 2 3/4"	8', 12'

SCENE I

ITEM NUMBER	DIMENSIONS	LENGTHS
CFF1W1PMD CROWN	3/4" x 4 1/4"	8', 12', 16'
CFF1W2PMD CROWN	3/4" x 5 1/4"	8', 12', 16'

ITEM NUMBER	DIMENSIONS	LENGTHS
CFF1C2PMD CASING	3/4" x 3 1/2"	8', 12'

Images do not reflect actual product size.



FRENCH CURVES



SYMMETRY MEETS ELEGANCE

The French Curves Collection is based on designs from the Greeks and Romans. That influence is evident from the architectural symmetry seen in the sculptural curves and pronounced convex elements. Yet their symmetry doesn't affect the elegance of these mouldings, which flow ornately across walls, and from the top to the bottom of a room.



WOOD AND PAINT

French Curves uses a mix of MDF and engineered Poplar to create voluptuous and graceful curves and play with classic forms to emulate a European Style. Take the paint-grade MDF in a classic French Traditional direction with a white tone. Or accent the curves with a rich color for a modern look.



THE CHOICE IS EASY

Deciding on mouldings and other finishing elements is easier with Metrie™ Then & Now Finishing Collections™. We enlisted the help of top interior designers to create coordinated foundational mouldings, trim and doors. Each of them is designed to work as a cohesive system and give you a base on which you can layer on a variety of decorative styles and trends.

FRENCH CURVES™

If you're inspired by the glamorous curves and classic forms of the Baroque and Empire periods, you'll love our French Curves Collection.

The elements here lean toward the formal and sculptural, but you can take them in so many contemporary directions. For example, with a simple whitewash you can bend the Collection toward Shabby Chic or Paris Flea Market. Use a dark shade of paint or stain and move it toward a Contemporary French Country. We've set three Scenes to help spur the possibilities. You decide how the elements are set, you choose the finish, you direct the scene.

The timeless, detailed look of this room was created by designer **Andrew Pike** with a mix of French Curves Scene I and Scene II.

FRENCH CURVES™

Doors

The French Curves interior doors have been designed to coordinate with all three trim Scenes, and are available in both solid core and glass options. Their Poplar construction truly shines through a clear coat or stain, but also creates a glamorous look with a light tone of paint. The patterned glass door carries the elegance and classic style of the Collection with the Hourglass texture.



CLEAR GLASS DOOR



HOURGLASS PATTERNED GLASS DOOR



SOLID DOOR POPLAR VENEER

Features

FRENCH CURVES DOORS

Panel Doors 1 3/8" Thick

Width		16"	18"	20"	22"	24"	26"	28"	30"	32"	34"	36"
Height	80"	•	•	•	•	•	•	•	•	•	•	•
	84"		•			•	•	•	•	•	•	•
	96"		•			•	•	•	•	•	•	•

Glass Doors 1 3/8" Thick

Width		24"	28"	30"	32"	36"						
Height	80"	•	•	•	•	•						
	84"	•	•	•	•	•						
	96"	•	•	•	•	•						

Premium solid core and glass doors are pre-hung on double-rabbeted jambs in Finger Joint Pine, Poplar or White Oak. Double doors do not arrive pre-hung; some assembly required.

Choice of four hinge finishes: Oil-Rubbed Bronze, Polished Chrome, Antique Brass and Satin Nickel.

- A wood core for a quality feel that resists warping and reduces sound transmission room to room
- Stile and rail, stain-grade poplar veneer construction
- 12" bottom rails for a grand, traditional look
- Glass doors are available in clear or textured, tempered glass, ensuring user safety
- Available pre-hung for easy installation and proper alignment in the frame
- Ball bearing hinges for smooth operation
- Double-rabbeted jamb available in 4 9/16" and 6 9/16"
- All doors can be special ordered as 20-minute fire-rated with 1 3/4" depth. Ask your supplier for more special order options.

French Curves moulding and trim elements within Scene III provide a design palette with larger profiles and more intricate architectural detail.

Scene III



CFCROSPOP | IKON
4" x 4"
6" x 6"

This French Curves Ikon™ is painted with a cream base color, and then finished with an ivory antiquing applied over the top. This technique creates an old-world, aged – Provencal style that accentuates the details of the Ikon™. All Ikons are sold unfinished.



CFC3B1SPO | POPLAR | BASEBOARD
3/4" x 7 1/4"



CFC3C1SPO | POPLAR | CASING
1 1/16" x 4 1/4"



CFC3C2SPO | POPLAR | CASING
1 1/16" x 3 1/2"



CFC3B2SPO | POPLAR | BASEBOARD
3/4" x 9 1/4"



CFC3L1SPO | POPLAR | CHAIR RAIL
3/4" x 4 1/4"



CFC3P1SPO | POPLAR | PANEL MOULD
5/8" x 1 7/8"



CFC3W2SPO | POPLAR | CROWN
3 5/8" x 8"
(INSTALLED DIMENSIONS)



CFC3A1SPO | POPLAR | ARCHITRAVE
2" x 7 1/4"



CFC3W1SPO | POPLAR | CROWN
3" x 6"
(INSTALLED DIMENSIONS)

The engineered Poplar in these finishing elements elegantly curves and rolls with the influences of the Baroque and Empire periods. The added curves and high crown mouldings that run up the wall add an illusion of height to a room.

Scene III

SCENE III

ITEM NUMBER	DIMENSIONS	LENGTHS
CFCROSPOP IKON	4" x 4", 1 1/4" Thick 6" x 6", 1" Thick	N/A
CFC3B1SPO BASEBOARD	3/4" x 7 1/4"	Random

ITEM NUMBER	DIMENSIONS	LENGTHS
CFC3C1SPO CASING	1 1/16" x 4 1/4"	Random
CFC3C2SPO CASING	1 1/16" x 3 1/2"	Random

SCENE III

ITEM NUMBER	DIMENSIONS	LENGTHS
CFC3B2SPO BASEBOARD	3/4" x 9 1/4"	Random
CFC3L1SPO CHAIR RAIL	3/4" x 4 1/4"	Random
CFC3P1SPO PANEL MOULD	5/8" x 1 7/8"	Random

ITEM NUMBER	DIMENSIONS	LENGTHS
CFC3W2SPO CROWN	3 5/8" x 8"	Random
CFC3A1SPO ARCHITRAVE	2" x 7 1/4"	Random
CFC3W1SPO CROWN	3" x 6"	Random

Images do not reflect actual product size.

French Curves Scene II gives you greater creative license with the addition of architraves and chair rails, both of which add grandeur and impact to any space.

Scene II

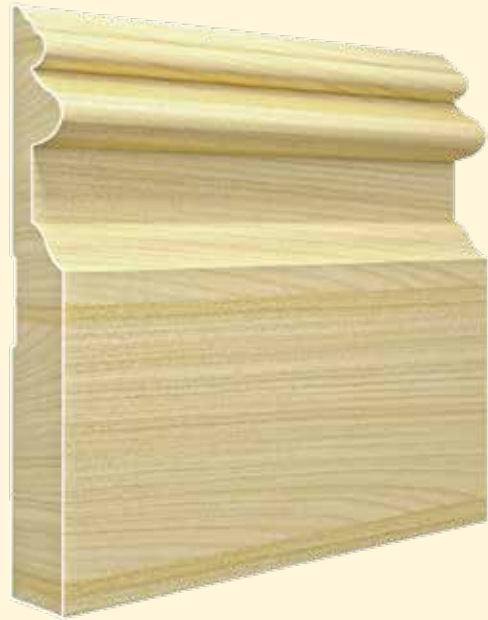

CFC2B2SPO | POPLAR | BASEBOARD
3/4" x 7 1/4"



CFC2A1SPO | POPLAR | ARCHITRAVE
1 1/16" x 5 5/16"



CFC2C2SPO | POPLAR | CASING
1" x 4 1/4"



CFC2C1SPO | POPLAR | CASING
1" x 3 1/2"



CFC2B1SPO | POPLAR | BASEBOARD
3/4" x 9 1/4"

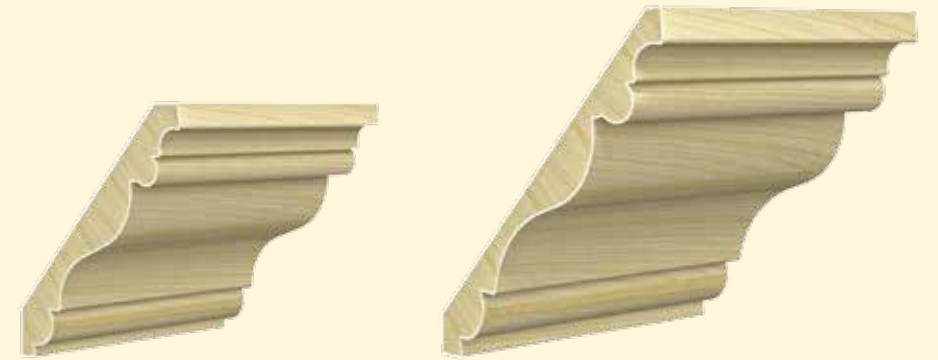

CFC2W2SPO | POPLAR | CROWN
3/4" x 5 1/4"

CFC2W1SPO | POPLAR | CROWN
3/4" x 7 1/4"



CFC2P1SPO | POPLAR | PANEL MOULD
9/16" x 1 1/2"



CFC2L1SPO | POPLAR | CHAIR RAIL
1 1/16" x 2"

Use the gentle rolls of these convex shapes to create a classically inspired room.

Add a touch of glamour with the pronounced convex designs of the Scene II elements and take their style in a classic yet modern direction with a rich color.

Scene II

SCENE II

ITEM NUMBER	DIMENSIONS	LENGTHS
CFC2B2SPO BASEBOARD	3/4" x 7 1/4"	Random

ITEM NUMBER	DIMENSIONS	LENGTHS
CFC2A1SPO ARCHITRAVE	1 1/16" x 5 5/16"	Random
CFC2C1SPO CASING	1" x 3 1/2"	Random
CFC2C2SPO CASING	1" x 4 1/4"	Random

SCENE II

ITEM NUMBER	DIMENSIONS	LENGTHS
CFC2B1SPO BASEBOARD	3/4" x 9 1/4"	Random
CFC2W2SPO CROWN	3/4" x 5 1/4"	Random

ITEM NUMBER	DIMENSIONS	LENGTHS
CFC2P1SPO PANEL MOULD	9/16" x 1 1/2"	Random
CFC2L1SPO CHAIR RAIL	1 1/16" x 2"	Random
CFC2W1SPO CROWN	3/4" x 7 1/4"	Random

Images do not reflect actual product size.

French Curves Scene I lets you finish a room with solid foundational essentials like crowns, casings and baseboards.

Scene I

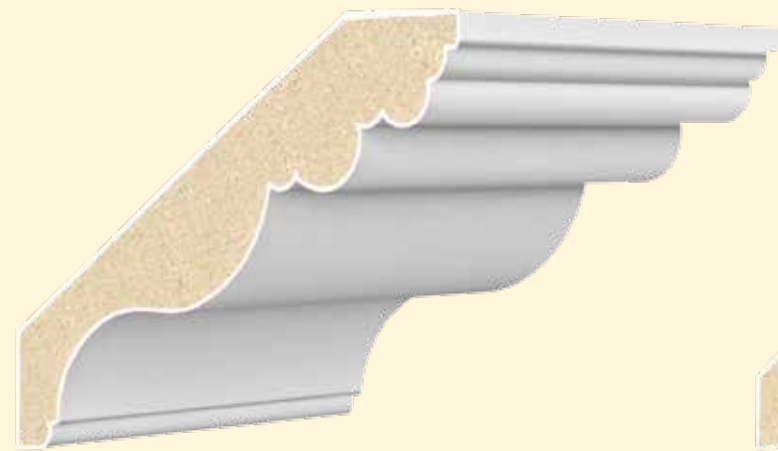

CFCIW2PMD | MDF | CROWN
1 3/16" x 7 1/4"

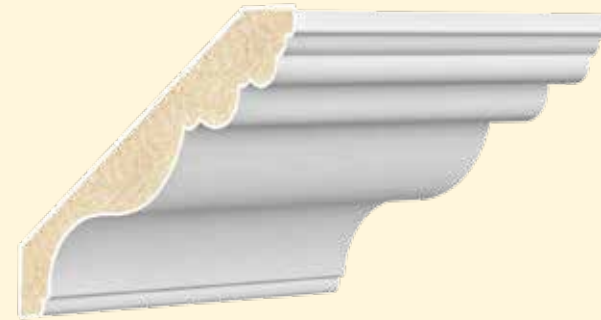

CFCIW1PMD | MDF | CROWN
3/4" x 5 1/4"



CFCIP1PMD | MDF | PANEL MOULD
1/2" x 1 1/8"
(IMAGE IS NOT TO SCALE)



CFCIC2PMD | MDF | CASING
1" x 3 1/2"



CFCIC1PMD | MDF | CASING
1" x 2 3/4"

Embrace the symmetry and bulbous, stylized nature of the French Curves Scene I elements. Made of MDF, these elements have beauty that shines through a light color of paint.

Scene I



CFCIA1PMD | MDF | ARCHITRAVE
1 1/2" x 5 1/2"

Classical form and a feminine feel, these French Curves elements add style and grace to any room.



CFCIB1PMD | MDF | BASEBOARD
3/4" x 4 1/4"



CFCIL1PMD | MDF | CHAIR RAIL
1" x 3 1/4"



CFCIB2PMD | MDF | BASEBOARD
3/4" x 5 1/2"

SCENE I

ITEM NUMBER	DIMENSIONS	LENGTHS
CFCIW2PMD CROWN	1 3/16" x 7 1/4"	8', 12', 16'
CFCIP1PMD PANEL MOULD	1/2" x 1 1/8"	8', 12'
CFCIC2PMD CASING	1" x 3 1/2"	8', 12'

ITEM NUMBER	DIMENSIONS	LENGTHS
CFCIW1PMD CROWN	3/4" x 5 1/4"	8', 12', 16'
CFCIC1PMD CASING	1" x 2 3/4"	8', 12'

SCENE I

ITEM NUMBER	DIMENSIONS	LENGTHS
CFCIA1PMD ARCHITRAVE	1 1/2" x 5 1/2"	8', 12'
CFCIB2PMD BASEBOARD	3/4" x 5 1/2"	8', 12', 16'

ITEM NUMBER	DIMENSIONS	LENGTHS
CFCIB1PMD BASEBOARD	3/4" x 4 1/4"	8', 12', 16'
CFCIL1PMD CHAIR RAIL	1" x 3 1/4"	8', 12'

Images do not reflect actual product size.



PRETTY SIMPLE



TRADITIONAL: REFRESHED

Push the boundaries of traditional Colonial Style with a modern twist of simplicity. The Red Oak creates a comforting, charming aesthetic that blends American Colonial design with simplified European Style for a refreshed look.



WOOD AND STAIN

Red Oak becomes the star in Pretty Simple Scene II finishing elements. Its red undertones glow warmly through stains and clear coats. It can also lean more Folk or Country with different finishes.



INSPIRED DESIGN

The Pretty Simple Collection is inspired by the charm and classical look of Colonial architecture. This interpretation was carefully designed to work with up-to-date design trends and styles.

PRETTY SIMPLE™

Are you attracted to symmetry, but not to pure Minimalism? Then you'll want to explore this Collection, inspired by the charming aesthetic and decorative detail of the Colonial period. Examine both Scenes carefully. You can easily take this Collection down the road to Folk Art with rich historical milk paint colors or more Country with mid-tone brown stains. We give you great bones to work with – you flesh out the scene.

Designer **Sandra Steiner-Houck** selected Pretty Simple Scene I and Scene II elements to push the boundaries of traditional design concepts in this room.

PRETTY SIMPLE™

doors

The Pretty Simple interior doors have been designed to coordinate with the two trim Scenes, and are available in both solid core and glass options. Their versatility of design styles works along with other elements in the Collection, letting you take them more Folk, Country, Colonial or Minimalist.



CLEAR GLASS DOOR



MILLENNIUM PATTERNED GLASS DOOR

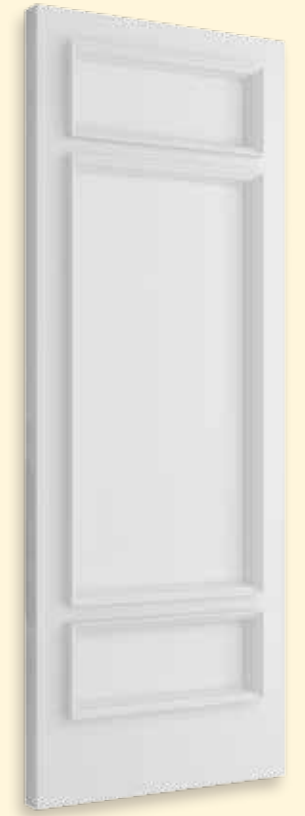

SOLID DOOR WOOD/MDF

Features

PRETTY SIMPLE DOORS

Panel Doors 1 3/8" Thick											
Width	16"	18"	20"	22"	24"	26"	28"	30"	32"	34"	36"
Height	80"	•	•	•	•	•	•	•	•	•	•
	84"	•	•	•	•	•	•	•	•	•	•
	96"	•	•	•	•	•	•	•	•	•	•
Glass Doors 1 3/8" Thick											
Width	24"	28"	30"	32"	36"						
Height	80"	•	•	•	•						
	84"	•	•	•	•						
	96"	•	•	•	•						

Premium solid core and glass doors are pre-hung on double-rabbeted jambs in Finger Joint Pine, Poplar or White Oak. Double doors do not arrive pre-hung; some assembly required.

Choice of four hinge finishes: Oil-Rubbed Bronze, Polished Chrome, Antique Brass and Satin Nickel.

- A wood core for a quality feel that resists warping and reduces sound transmission room to room
- Stile and rail door made from paint-grade material
- 12" bottom rails work in both traditional and contemporary spaces
- Glass doors are available in clear or textured, tempered glass, ensuring user safety
- Available pre-hung for easy installation and to ensure proper alignment in the frame
- Ball bearing hinges for smooth operation
- Double-rabbeted jamb available in 4 9/16" and 6 9/16"
- All doors can be special ordered as 20-minute fire-rated with 1 3/4" depth. Ask your supplier for more special order options.

Pretty Simple Scene II gives you greater creative license with the addition of architraves and chair rails, both of which add grandeur and impact to any space.

Scene II



CPSROPOP | IKON
4" x 4"
6" x 6"

This Pretty Simple Ikon™ is finished in rich, coffee-colored stain with a black highlight that was applied and rubbed away. This treatment creates a traditional look that can be carried throughout an entire room. All Ikons are sold unfinished.



CPS2AISRO | RED OAK | ARCHITRAVE
1 1/16" x 5 5/16"



CPS2C2SRO | RED OAK | CASING
1" x 4 1/4"



CPS2W2SRO | RED OAK | CROWN
1" x 6 3/8"

Celebrate these distinct wood patterns with a light stain or clear coat.

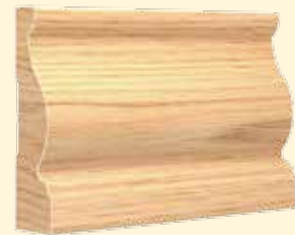

CPS2CISRO | RED OAK | CASING
13/16" x 3 1/4"



CPS2WISRO | RED OAK | CROWN
3/4" x 4 1/4"



CPS2B2SRO | RED OAK | BASEBOARD
3/4" x 7 1/4"



CPS2BISRO | RED OAK | BASEBOARD
3/4" x 5 1/4"



CPS2LISRO | RED OAK | CHAIR RAIL
9/16" x 2 5/8"



CPS2PISRO | RED OAK | PANEL MOULD
1/2" x 1 1/2"

Scene II

The Scene II mouldings and finishing elements feature an ogee, or S-shaped, cut design to connect them all together, and the Red Oak's red glow warms its way through a rich stain.

SCENE II

ITEM NUMBER	DIMENSIONS	LENGTHS
CPSROPOP IKON	4" x 4", 1 1/4" Thick 6" x 6", 1" Thick	N/A
CPS2C2SRO CASING	1" x 4 1/4"	Random

ITEM NUMBER	DIMENSIONS	LENGTHS
CPS2AISRO ARCHITRAVE	1 1/16" x 5 5/16"	Random
CPS2W2SRO CROWN	1" x 6 3/8"	Random

SCENE II

ITEM NUMBER	DIMENSIONS	LENGTHS
CPS2CISRO CASING	13/16" x 3 1/4"	Random
CPS2WISRO CROWN	3/4" x 4 1/4"	Random
CPS2B2SRO BASEBOARD	3/4" x 7 1/4"	Random

ITEM NUMBER	DIMENSIONS	LENGTHS
CPS2BISRO BASEBOARD	3/4" x 5 1/4"	Random
CPS2LISRO CHAIR RAIL	9/16" x 2 5/8"	Random
CPS2PISRO PANEL MOULD	1/2" x 1 1/2"	Random

Images do not reflect actual product size.

Pretty Simple Scene I lets you finish a room with solid foundational essentials like crowns, casings and baseboards.

Scene I



CPS1B2PMD | MDF | BASEBOARD
3/4" x 7 1/4"

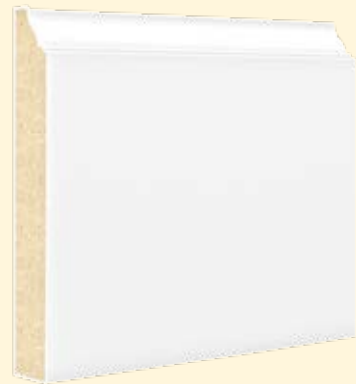

CPS1B1PMD | MDF | BASEBOARD
3/4" x 5 1/4"



CPS1P1PMD | MDF | PANEL MOULD
9/16" x 1 1/2"

The familiar, comfortable design of the Colonial period meets a Minimalist Style with these primed MDF mouldings. Comfort and charm emanate from these designs when coated in an inviting tone of paint.

Scene I

Paint this trim and the walls the same color for a contemporary look, or give them colors that create high contrast with the walls for a traditional feel.



CPS1W1PMD | MDF | CROWN
5/8" x 4 1/4"



CPS1C2PMD | MDF | CASING
1" x 3 3/8"



CPS1W2PMD | MDF | CROWN
5/8" x 5 1/4"



CPS1C1PMD | MDF | CASING
1" x 2 3/4"



CPS1L1PMD | MDF | CHAIR RAIL
5/8" x 2 1/2"

SCENE I

ITEM NUMBER	DIMENSIONS	LENGTHS
CPS1B2PMD BASEBOARD	3/4" x 7 1/4"	8', 12', 16'

ITEM NUMBER	DIMENSIONS	LENGTHS
CPS1B1PMD BASEBOARD	3/4" x 5 1/4"	8', 12', 16'
CPS1P1PMD PANEL MOULD	9/16" x 1 1/2"	8', 12'

SCENE I

ITEM NUMBER	DIMENSIONS	LENGTHS
CPS1C2PMD CASING	1" x 3 3/8"	8', 12'
CPS1W1PMD CROWN	5/8" x 4 1/4"	8', 12', 16'

ITEM NUMBER	DIMENSIONS	LENGTHS
CPS1W2PMD CROWN	5/8" x 5 1/4"	8', 12', 16'
CPS1L1PMD CHAIR RAIL	5/8" x 2 1/2"	8', 12'
CPS1C1PMD CASING	1" x 2 3/4"	8', 12'

Images do not reflect actual product size.



TRUE CRAFT



UNUSUAL COMBINATIONS

True Craft Scene III finishing elements come together in interesting ways in this room. Fir chair rail was used to create a tall, 6-foot high wainscoting effect. Ikons™ adorn the corners of the barn-style sliding doors to add texture and detail. The fireplace is also embellished with two large casings combined to create a butterfly pattern.



WOOD AND STAIN

These Scene III vertical grain Fir mouldings create a natural, rustic feel. The addition of a gray-tinted stain helps showcase the intricate grain of the Fir, while subduing its red undertones. This adds to the authentic, modern aesthetic of the room.



PROPORTION AND FIT

This grand room is the perfect setting for the larger, substantial moulding style of the True Craft Collection. These larger elements are meticulously proportioned to create a Craftsman Style look, while giving this large space a more comfortable feel.

TRUE CRAFT™

The warmth and honesty of authentic, utilitarian design. There's nothing quite like the aesthetic created by the Craftsman, Mission and Prairie Style movements. Simple, linear, direct. Use these elements as the setting to create a Southwest Style with sun-washed tones. Go Mountain Modern by dry brushing a cool gray stain. Create a mid-century Bungalow feel by letting the Fir grain show through a warm whitewashed paint. So many places to land when you start here.

Designer **Donna Guerra** evokes a cozy, rustic feel with the beautiful look of vertical grain Fir from the True Craft Scene III elements.



TRUE CRAFT™

doors

True Craft interior doors have been designed to coordinate with all three trim Scenes and are available in both solid core and glass options. The interior sticking of all three doors uses a chamfer design that echoes the warm, authentic craftsmanship style of the Collection. The patterned glass door also adds to the sincere nature of the Collection with the exclusive Pendulum pattern.



CLEAR GLASS DOOR



PENDULUM PATTERNED
GLASS DOOR



SOLID DOOR
MDF

Features

TRUE CRAFT DOORS

Panel Doors 1 3/8" Thick

Width	16"	18"	20"	22"	24"	26"	28"	30"	32"	34"	36"
80"	•	•	•	•	•	•	•	•	•	•	•
84"		•			•	•	•	•	•	•	•
96"		•			•	•	•	•	•	•	•

Glass Doors 1 3/8" Thick

Width	24"	28"	30"	32"	36"						
80"	•	•	•	•	•						
84"	•	•	•	•	•						
96"	•	•	•	•	•						

Premium solid core and glass doors are pre-hung on double-rabbeted jambs in Finger Joint Pine, Poplar or White Oak. Double doors do not arrive pre-hung; some assembly required.

Choice of four hinge finishes: Oil-Rubbed Bronze, Polished Chrome, Antique Brass and Satin Nickel.

- A wood core for a quality feel that resists warping and reduces sound transmission room to room
- Stile and rail door made from paint-grade material
- 12" bottom rails fit proportionally with today's larger homes
- Interior sticking uses a chamfer design that echoes the Craftsman style of the Collection.
- Glass doors are available in clear or textured, tempered glass, ensuring user safety
- Available pre-hung for easy installation and proper alignment in the frame
- Ball bearing hinges for smooth operation
- Double-rabbeted jamb available in 4 9/16" and 6 9/16"
- All doors can be special ordered as 20-minute fire-rated with 1 3/4" depth. Ask your supplier for more special order options.

True Craft moulding and trim elements within Scene III provide a design palette with larger profiles and more intricate architectural detail.

Scene III

Scene III

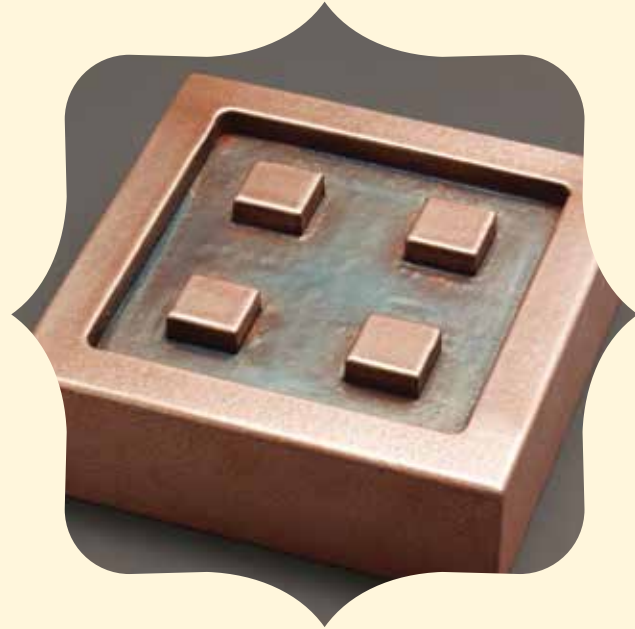

CTCROPOP | IKON
4" x 4"
6" x 6"

This True Craft Ikon™ was finished in a copper metallic paint and then polished to highlight the frame and pegs. This piece would be an excellent accent to accompany the vertical Fir grain of the True Craft Scene III mouldings. All Ikons are sold unfinished.



CTC3C4VFI | (VG) FIR | CASING
1 3/4" x 5 1/2"



CTC3C2VFI | (VG) FIR | CASING
1 3/8" x 3 1/2"



CTC3B2VFI | (VG) FIR | BASEBOARD
1" x 9 1/4"



CTC3PIVFI | (VG) FIR | PANEL MOULD
3/4" x 3 1/2"

Finish this wood with a dry-brushed, cool gray stain for a Mountain Modern look.



CTC3C3VFI | (VG) FIR | CASING
1 7/16" x 5 1/2"

SCENE III

ITEM NUMBER	DIMENSIONS	LENGTHS
CTCROPOP IKON	4" x 4", 1 1/4" Thick 6" x 6", 1" Thick	N/A

ITEM NUMBER	DIMENSIONS	LENGTHS
CTC3C4VFI CASING	1 3/4" x 5 1/2"	Random
CTC3C2VFI CASING	1 3/8" x 3 1/2"	Random

SCENE III

ITEM NUMBER	DIMENSIONS	LENGTHS
CTC3B2VFI BASEBOARD	1" x 9 1/4"	Random
CTC3PIVFI PANEL MOULD	3/4" x 3 1/2"	Random

ITEM NUMBER	DIMENSIONS	LENGTHS
CTC3C3VFI CASING	1 7/16" x 5 1/2"	Random

Images do not reflect actual product size.

The beauty of vertical grain (VG) Douglas Fir comes to life with finishing elements in the True Craft Scene III Collection. The oversize wedge shapes and large crown mouldings in this Scene beautifully showcase the multiple linear lines of Douglas Fir.

Scene III



CTC3BIVFI | (VG) FIR | BASEBOARD
1" x 7 1/4"



CTC3LIVFI | (VG) FIR | CHAIR RAIL
5/8" x 5 1/2"



CTC3CIVFI | (VG) FIR | CASING
1 3/8" x 3 1/2"



CTC3W2VFI | (VG) FIR | CROWN
5 7/16" x 8 13/16"
(INSTALLED DIMENSIONS)

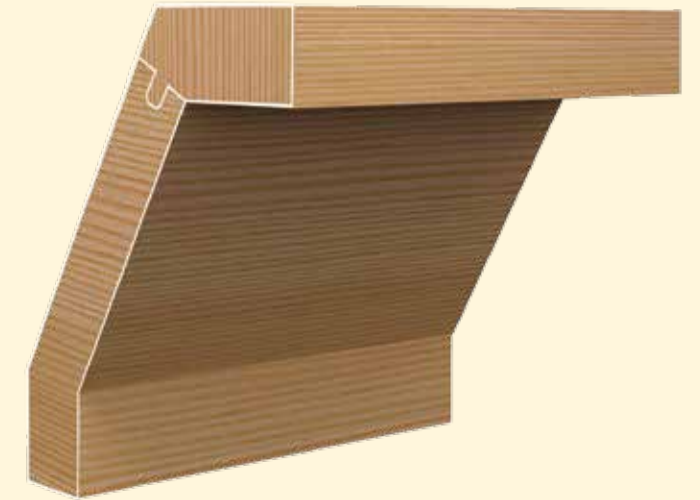

CTC3W1VFI | (VG) FIR | CROWN
4 1/2" x 7"
(INSTALLED DIMENSIONS)



CTC3AIVFI | (VG) FIR | ARCHITRAVE
1 3/4" x 7 1/4"

SCENE III

ITEM NUMBER	DIMENSIONS	LENGTHS
CTC3BIVFI BASEBOARD	1" x 7 1/4"	Random
CTC3LIVFI CHAIR RAIL	5/8" x 5 1/2"	Random

ITEM NUMBER	DIMENSIONS	LENGTHS
CTC3CIVFI CASING	1 3/8" x 3 1/2"	Random

SCENE III

ITEM NUMBER	DIMENSIONS	LENGTHS
CTC3W2VFI CROWN	5 7/16" x 8 13/16"	Random

ITEM NUMBER	DIMENSIONS	LENGTHS
CTC3W1VFI CROWN	4 1/2" x 7"	Random
CTC3AIVFI ARCHITRAVE	1 3/4" x 7 1/4"	Random

Images do not reflect actual product size.

True Craft Scene II gives you greater creative license with the addition of architraves and chair rails, both of which add grandeur and impact to any space.

Scene II

Celebrate these mixed grain wood patterns with a light stain or clear coat.



CTC2B2MFI | FIR | BASEBOARD
3/4" x 7 1/4"



CTC2C1MFI | FIR | CASING
1" x 3 1/2"



CTC2C2MFI | FIR | CASING
1" x 4 1/2"



CTC2B1MFI | FIR | BASEBOARD
3/4" x 5 1/4"



CTC2W1MFI | FIR | CROWN
5/8" x 4 1/4"



CTC2W2MFI | FIR | CROWN
3/4" x 7 1/4"



CTC2A1MFI | FIR | ARCHITRAVE
1 7/16" x 7 1/4"



CTC2L1MFI | FIR | CHAIR RAIL
3/4" x 3 1/2"

Embrace the natural feel of mixed grain Douglas Fir in the True Craft Scene II Collection. The varying grain patterns truly celebrate the wood's natural feel, which can be found in additional profiles that help you create simplicity and style in any room.

Scene II

SCENE II

ITEM NUMBER	DIMENSIONS	LENGTHS
CTC2B2MFI BASEBOARD	3/4" x 7 1/4"	Random
CTC2C1MFI CASING	1" x 3 1/2"	Random

ITEM NUMBER	DIMENSIONS	LENGTHS
CTC2C2MFI CASING	1" x 4 1/2"	Random
CTC2B1MFI BASEBOARD	3/4" x 5 1/4"	Random

SCENE II

ITEM NUMBER	DIMENSIONS	LENGTHS
CTC2W1MFI CROWN	5/8" x 4 1/4"	Random
CTC2W2MFI CROWN	3/4" x 7 1/4"	Random

ITEM NUMBER	DIMENSIONS	LENGTHS
CTC2A1MFI ARCHITRAVE	1 7/16" x 7 1/4"	Random
CTC2L1MFI CHAIR RAIL	3/4" x 3 1/2"	Random

Images do not reflect actual product size.

True Craft Scene I lets you finish a room with solid foundational essentials like crowns, casings and baseboards.

Scene I



CTC1B2PMD | MDF | BASEBOARD
3/4" x 5 3/4"



CTC1W1PMD | MDF | CROWN
1 1/2" x 4 1/4"



CTC1W2PMD | MDF | CROWN
1 1/2" x 5 1/4"



CTC1A1PMD | MDF | ARCHITRAVE
1 1/2" x 5"



CTC1C1PMD | MDF | CASING
1" x 2 3/4"



CTC1C2PMD | MDF | CASING
1" x 3 1/2"



CTC1B1PMD | MDF | BASEBOARD
3/4" x 4"

Explore the Craftsman, Mission and Prairie Style movements with these simple, linear finishing elements. This paint-grade MDF is durable, easy to install, and can be finished many ways, such as adding a sun-washed tone to give your space a Southwest Style.

Scene I

SCENE I

ITEM NUMBER	DIMENSIONS	LENGTHS
CTC1B2PMD BASEBOARD	3/4" x 5 3/4"	8', 12', 16'

ITEM NUMBER	DIMENSIONS	LENGTHS
CTC1W1PMD CROWN	1 1/2" x 4 1/4"	8', 12', 16'
CTC1W2PMD CROWN	1 1/2" x 5 1/4"	8', 12', 16'

SCENE I

ITEM NUMBER	DIMENSIONS	LENGTHS
CTC1A1PMD ARCHITRAVE	1 1/2" x 5"	8', 12'
CTC1C1PMD CASING	1" x 2 3/4"	8', 12'

ITEM NUMBER	DIMENSIONS	LENGTHS
CTC1B1PMD BASEBOARD	3/4" x 4"	8', 12', 16'
CTC1C2PMD CASING	1" x 3 1/2"	8', 12'

Images do not reflect actual product size.



VERY SQUARE



SIMPLE GOES ZEN

The traditional, geometric lines of Very Square can take on many different characters. Use medium-toned paint on both your walls and trim to give these strong lines a warm Asian Zen feel. They can also mimic an Art Deco look, as well as many other styles.

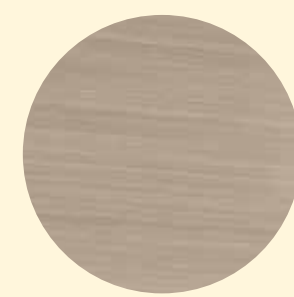

WOOD AND STAIN

Rift cut White Oak in Scene III creates a decidedly contemporary look through the use of long linear grain patterns. Take it West Coast Contemporary with a glossy white finish, or use a lighter stain to let the grain shine through.



STRONG LINES

The Very Square Finishing Collection embraces the beauty of strong lines and a precise geometry that lend themselves to a variety of styles. These lines create a simple Urban feel without appearing overly decorative.

VERY SQUARE™

Art Deco meets Asian Zen. You'll see notes from the tech world. If you're drawn to strong, crisp lines and precise geometry, this Collection is a great place to start. Finish it with clean white paint and go West Coast Contemporary. Stain it a light matte and bring out the Minimalist. Use today's hottest paint color and take it to the Urban Edge. Very Square is a great foundation on which to layer the most contemporary styles.

Designers **Alexandre Blazys** and **Benoit Gérard** paired eclectic accessories with Very Square Scene II mouldings to define this home office.

VERY SQUARE™

Doors

The Very Square interior doors have been designed to coordinate with all three trim Scenes, and are available in both solid core and glass options, including a flush design on the Rift Cut solid door. The horizontal grain of the rift cut White Oak echoes the lines of the Collection and allows for a modern interpretation of the style. You can also carry this Collection's style with the Tempo pattern in the patterned glass door option.



CLEAR GLASS DOOR



TEMPO PATTERNED GLASS DOOR



SOLID DOOR RIFT CUT WHITE OAK VENEER



4-PANEL DOOR

Features

VERY SQUARE DOORS

Solid Doors 1 3/8" Thick												
Width		16"	18"	20"	22"	24"	26"	28"	30"	32"	34"	36"
Height	80"	•	•	•	•	•	•	•	•	•	•	•
	84"		•			•	•	•	•	•	•	•
	96"		•			•	•	•	•	•	•	•
Glass Doors 1 3/8" Thick												
Width		24"	28"	30"	32"	36"						
Height	80"	•	•	•	•	•						
	84"	•	•	•	•	•						
	96"	•	•	•	•	•						
4-Panel Doors 1 3/8" Thick												
Width		24"	26"	28"	30"	32"	34"	36"				
Height	80"	•	•	•	•	•	•	•				
	84"	•	•	•	•	•	•	•				

Premium solid core and glass doors are pre-hung on double-rabbeted jambs in Finger Joint Pine, Poplar or White Oak. Double doors do not arrive pre-hung; some assembly required.

Choice of four hinge finishes: Oil-Rubbed Bronze, Polished Chrome, Antique Brass and Satin Nickel.

- A wood core for a quality feel that resists warping and reduces sound transmission room to room
- Horizontal rift cut white oak veneer on the solid flush option
- 4-Panel moulded option, primed and ready for paint
- Glass doors are available in clear or textured, tempered glass, ensuring user safety
- Available pre-hung for easy installation and proper alignment in the frame
- Ball bearing hinges for smooth operation
- Double-rabbeted jamb available in 4 9/16" and 6 9/16"
- All doors can be special ordered as 20-minute fire-rated with 1 3/4" depth. Ask your supplier for more special order options.

Very Square moulding and trim elements within Scene III provide a design palette with larger profiles and more intricate architectural detail.

Staining these long, crisp edges with horizontal graining can take Scene III elements in an Asian Zen or Art Deco Style with a minimal approach.

Scene III

Scene III



CVSROPOP | IKON
4" x 4"
6" x 6"

This Very Square Ikon™ was painted black, and then painted with a white overcoat for a contemporary play on black and white. This finish echoes the design of the Very Square Collection and could be an excellent addition to a picture frame for black and white photography. All Ikons are sold unfinished.



CVS3B2SWO | WHITE OAK | BASEBOARD
3/4" x 6 1/2"



CVS3B1SWO | WHITE OAK | BASEBOARD
3/4" x 3 1/2"



CVS3P1SWO | WHITE OAK | PANEL MOULD
3/4" x 2"



CVS3L1SWO | WHITE OAK | CHAIR RAIL
3/4" x 3"



CVS3C2SWO | WHITE OAK | CASING
1" x 4 1/2"



CVS3W1SWO | WHITE OAK | CROWN
3" x 6"
(INSTALLED DIMENSIONS)



CVS3C1SWO | WHITE OAK | CASING
1/2" x 3 1/2"



CVS3W2SWO | WHITE OAK | CROWN
2" x 8"

Create a variety of styles with these Collection profiles by applying a stain that brings out the wood's natural beauty

SCENE III

ITEM NUMBER	DIMENSIONS	LENGTHS
CVSROPOP IKON	4" x 4", 1 1/4" Thick 6" x 6", 1" Thick	N/A

ITEM NUMBER	DIMENSIONS	LENGTHS
CVS3B2SWO BASEBOARD	3/4" x 6 1/2"	Random
CVS3C2SWO CASING	1" x 4 1/2"	Random

SCENE III

ITEM NUMBER	DIMENSIONS	LENGTHS
CVS3B1SWO BASEBOARD	3/4" x 3 1/2"	Random
CVS3W1SWO CROWN	3" x 6"	Random
CVS3P1SWO PANEL MOULD	3/4" x 2"	Random

ITEM NUMBER	DIMENSIONS	LENGTHS
CVS3C1SWO CASING	1/2" x 3 1/2"	Random
CVS3L1SWO CHAIR RAIL	3/4" x 3"	Random
CVS3W2SWO CROWN	2" x 8"	Random

Images do not reflect actual product size.

Very Square Scene II gives you greater creative license with the addition of architraves and chair rails, both of which add grandeur and impact to any space.

Scene II



CVS2B2PMD | MDF | BASEBOARD
3/4" x 7 1/4"

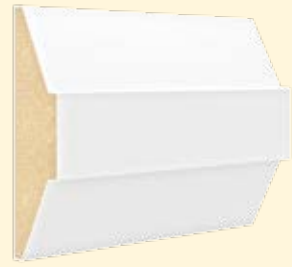

CVS2L1PMD | MDF | CHAIR RAIL
1" x 3 1/2"



CVS2C2PMD | MDF | CASING
1" x 4 1/2"



CVS2B1PMD | MDF | BASEBOARD
3/4" x 5 1/2"

Embrace the angled, geometric lines of the Scene II panel moulding, architrave and chair rail. Their crisp shapes evoke a West Coast Contemporary Style with a solid coat of paint.

Scene II



CVS2P1PMD | MDF | PANEL MOULD
1/2" x 2"



CVS2A1PMD | MDF | ARCHITRAVE
1 1/2" x 6 1/2"



CVS2C1PMD | MDF | CASING
1" x 3 1/2"



CVS2W1PMD | MDF | CROWN
1 1/4" x 6 1/4"

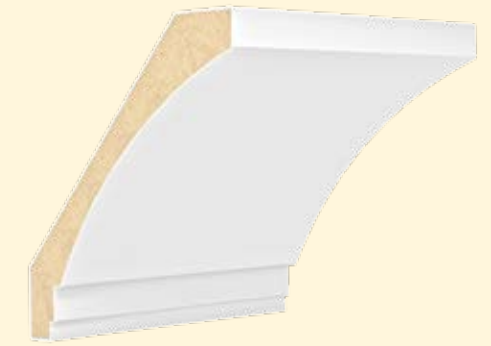

CVS2W2PMD | MDF | CROWN
1 1/4" x 7 3/4"

SCENE II

ITEM NUMBER	DIMENSIONS	LENGTHS
CVS2B2PMD BASEBOARD	3/4" x 7 1/4"	8', 12', 16'
CVS2C2PMD CASING	1" x 4 1/2"	8', 12'

ITEM NUMBER	DIMENSIONS	LENGTHS
CVS2L1PMD CHAIR RAIL	1" x 3 1/2"	8', 12'
CVS2B1PMD BASEBOARD	3/4" x 5 1/2"	8', 12', 16'

SCENE II

ITEM NUMBER	DIMENSIONS	LENGTHS
CVS2A1PMD ARCHITRAVE	1 1/2" x 6 1/2"	8', 12'
CVS2W1PMD CROWN	1 1/4" x 6 1/4"	8', 12', 16'

ITEM NUMBER	DIMENSIONS	LENGTHS
CVS2P1PMD PANEL MOULD	1/2" x 2"	8', 12'
CVS2C1PMD CASING	1" x 3 1/2"	8', 12'
CVS2W2PMD CROWN	1 1/4" x 7 3/4"	8', 12', 16'

Images do not reflect actual product size.

Very Square Scene I lets you finish a room with solid foundational essentials like crowns, casings and baseboards.

Scene I

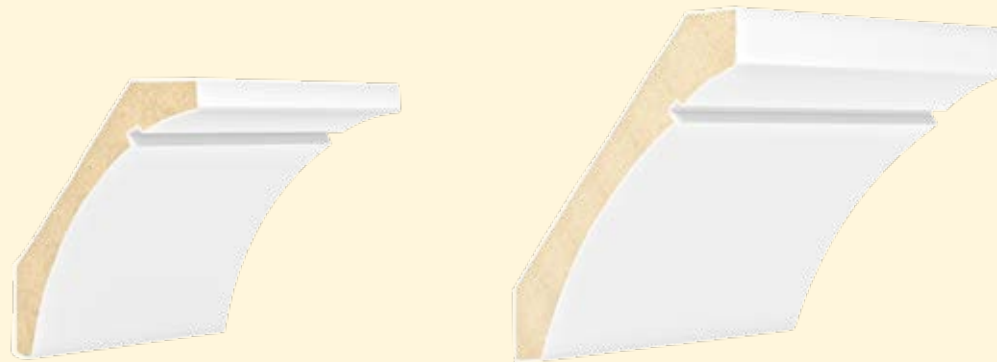

CVSIW1PMD | MDF | CROWN
1 3/16" x 5 7/16"

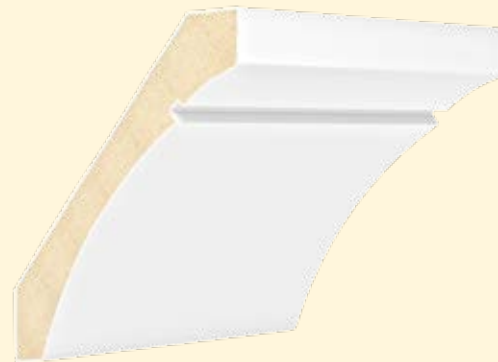

CVSIW2PMD | MDF | CROWN
1 3/16" x 7"



CVSIB2PMD | MDF | BASEBOARD
9/16" x 5 1/2"

The notch details of Very Square Scene I casings and baseboards make them easier to paint, and their clean lines create a Minimalist look in any space.

Scene I



CVSIC2PMD | MDF | CASING
3/4" x 3 1/2"



CVSIB1PMD | MDF | BASEBOARD
9/16" x 4 1/2"



CVSIC1PMD | MDF | CASING
3/4" x 2 3/4"

Embrace the simple, minimal character of these elements and their notch detailing.

SCENE I

ITEM NUMBER	DIMENSIONS	LENGTHS
CVSIW1PMD CROWN	1 3/16" x 5 7/16"	8', 12', 16'
CVSIW2PMD CROWN	1 3/16" x 7"	8', 12', 16'

ITEM NUMBER	DIMENSIONS	LENGTHS
CVSIB2PMD BASEBOARD	9/16" x 5 1/2"	8', 12', 16'

SCENE I

ITEM NUMBER	DIMENSIONS	LENGTHS
CVSIC2PMD CASING	3/4" x 3 1/2"	8', 12'
CVSIB1PMD BASEBOARD	9/16" x 4 1/2"	8', 12', 16'

ITEM NUMBER	DIMENSIONS	LENGTHS
CVSIC1PMD CASING	3/4" x 2 3/4"	8', 12'

Images do not reflect actual product size.



In addition to our perfectly coordinated Finishing Collections, Metrie™ offers thousands of Interior Finishing products in a variety of wood species.

Browse the following pages to see the diverse range of options available in your area. Visit Metrie.com for more information on Metrie Complete,™ SPERO™ Eco-wise environmental products and helpful tools for the trade professional.

REGIONAL PRODUCTS

naturally wood

Wood. Organic, natural – there's nothing quite like it.

Strong and durable, yet soft and warm, a family of personalities each expressed through grain and character. Bold, reserved, mysterious, determined.

We use wood as a catalyst for transformation. Each species has the power to redefine a space and lend a character that is completely unique.

Red Oak can create a warm and traditional look, while Poplar creates a crisp, modern feel. Understanding the differences between types of wood opens new doors to design and brings us closer to the natural world.



HEMLOCK

Hemlock is a design chameleon; it can be used to create a variety of different looks simply by switching grain direction, types of stain and more. Its diversity of looks makes it a designer favorite. Embrace your style with a stain or play with alternating grains for a unique look.



DOUGLAS FIR

A softwood, Douglas Fir is offered in two different grains. The mixed grain truly celebrates the wood's natural feel and depicts a Southwest Style with a creamy, sun-washed tone. You can also paint it a warm white to create a Bungalow Style. The popular vertical grain is a prestigious cut of Fir, combining multiple linear lines stacked on top of each other. Showcase the beauty of vertical grain with a dry-brushed, cool gray stain for an of-the-moment look.



RED OAK

Red Oak is versatile, yet traditional. It is the hardest wood in our offering and creates a strong, traditional look with a red undertone. Use Red Oak with a variety of stains to evoke a Colonial feel that glows with red warmth. Red Oak can be found in the Pretty Simple Collection and in other Metrie™ products.

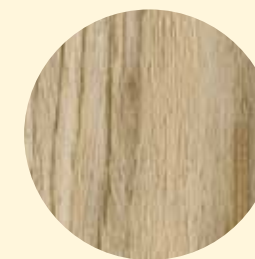

WHITE OAK

A designer favorite, this hardwood has a decidedly Contemporary look and can be found in the Very Square Collection. By using rift cuts, which run from the center of the tree outward and are perpendicular to the grain, White Oak creates long, linear lines that echo the personality of Minimalist designs. Create a West Coast Contemporary Style with a glossy white, or get an Urban Edge with the year's popular colors. Both paints and stains lay well over White Oak's grains, while still allowing them to show through.



POPLAR

Another designer favorite when paint-grade wood is needed, Poplar is one of the softer hardwood species. Typically, Poplar's smaller lengths of wood have been used to create finger joints, where ends of pieces are notched and slide together – just like interlacing your fingers. We have aligned and combined sections of Poplar to create larger lengths of this beautiful wood, also known as engineered Poplar. Accent its crisp grain lines with rich tones of stain or paint it for a more modern look.



EASTERN MAPLE

A harder, straight-grain wood, Maple adds a natural luxury to any space. Maple's blond color and mild graining create a Contemporary look and work well with many different stains. Add a varnish for a woodsier feel, or coat it with a medium stain to make it more Contemporary.



FINGER JOINT PINE

This softer, easy-to-work-with wood comes pre-primed with a lacquer-based primer. It eliminates grain raise, fuzzing and conceals the finger joints. Its softer nature makes it easy to install, which makes it very popular. This type of wood works best when painted.



KNOTTY PINE

Soft, yet bold, Knotty Pine adds a distinct character to a room. Its reddish-brown knots create interest and texture. Add a darker stain to subdue differences in the grain and knots, or add a clear finish to celebrate the character of the wood and create a more rustic Country look.



MDF

Soft and easy to install, MDF offers similar benefits to Finger Joint Pine. It is manufactured in standard builder lengths; is free of knots, splits, checks or raised grains; and copes and miters easily.



ALDER

This softer, sometimes knotty, wood adds a rustic look much like Knotty Pine. Alder has a natural red undertone and can have either prominent or subdued graining. Its rustic and woody appearance creates a distinctly West Coast Style but can be used anywhere.

ARCHITRAVES

High above windows and doors, architraves work to add grandeur to any space – reducing miter lines and elevating your look. A great architrave is, above all else, the dressing that’s built to impress.



Stock Code Dimensions
9032POP 3/4" x 3 1/2" x 16'
POP

9032PRI 3/4" x 3 1/2" x 16'
PRI

9032PRII90 3/4" x 3 1/2" x 90"
PRI



Stock Code Dimensions
34112HCAPRI 1 1/16" x 3 1/2" x 16'
PRI



Stock Code Dimensions
523M 1" x 3 1/2" x 16'
MDF/UL

523P 1 1/16" x 3 1/2" x 16'
FJP



Stock Code Dimensions
24112CAJ 1 1/16" x 3 1/2" x 16'
FJP

24112CAM 1 1/16" x 3 1/2" x 16'
MDF/UL



Stock Code Dimensions
480KP 1 1/16" x 3 1/2" x 16'
FPP



Stock Code Dimensions
5010M 1 3/16" x 4 1/4" x 16'
MDF/UL

ARCHITRAVES

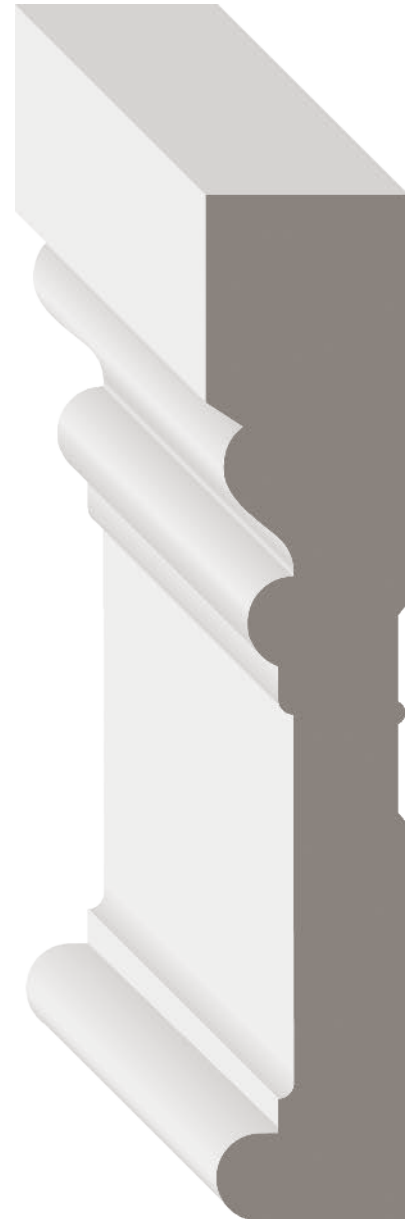

Stock Code Dimensions
190DHM 1 1/16" x 5 1/4" x 16'
MDF/UL

190DHPOP 1 1/16" x 5 5/16" x 16'
POP



Stock Code Dimensions
5030M 1 3/16" x 6 1/4" x 16'
MDF/UL

BACK BANDS

BACK BANDS

Back bands are used in conjunction with casing or baseboard to create a wide variety of trim options for windows and doors.

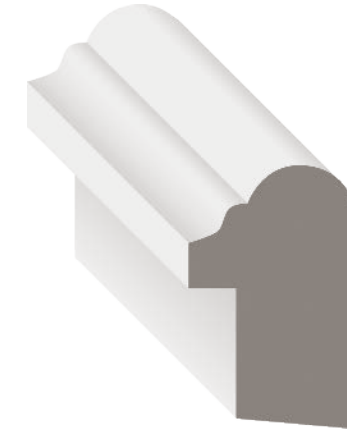

Stock Code Dimensions
2844BBP 7/8" x 1 3/8" x 16'
FPP

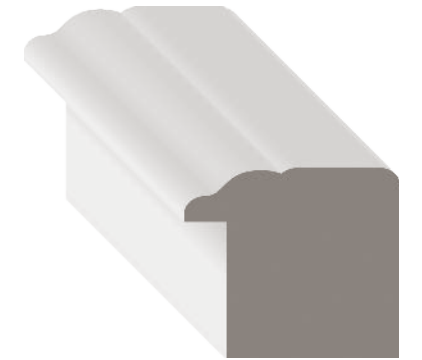

Stock Code Dimensions
818MF08 1" x 1 1/8" x 8'
MDF/UL



Stock Code Dimensions
280 1 1/16" x 1" x RL
PIN

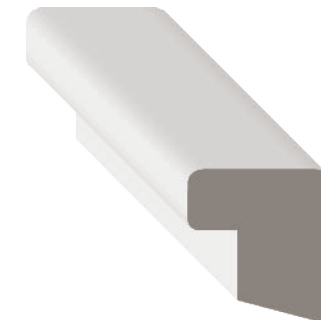

Stock Code Dimensions
9701PRI 3/4" x 1 3/16" x 16'
PRI

9705PRI 3/4" x 1 1/16" x 16'
PRI

9705PRIF08 3/4" x 1 1/16" x 8'
PRI

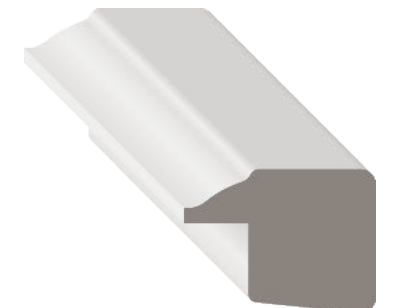

Stock Code Dimensions
10160 3/4" x 1" x RL
O

1016POP 3/4" x 1" x RL
POP

1016POPI90 3/4" x 1" x 90"
POP

BACK BANDS

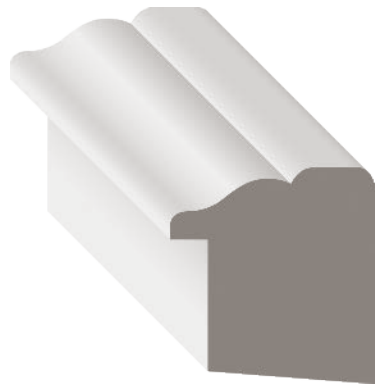

Stock Code Dimensions
3436BBPOP 1 1/8" x 1 5/8" x RL
POP

3436BBPOPI90 1 1/8" x 1 1/8" x 90"
POP

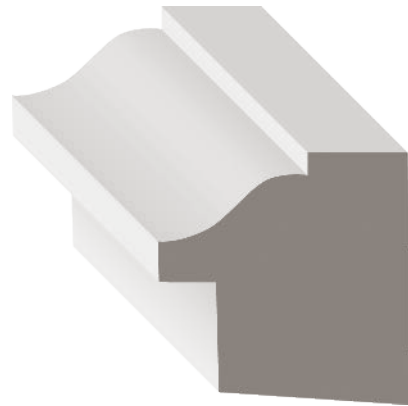

Stock Code Dimensions
281LPRI 1 1/16" x 1 1/8" x 16'
PRI

281LPRIF08 1 1/16" x 1 1/8" x 8'
PRI



Stock Code Dimensions
3652BBPOP 1 1/8" x 1 5/8" x RL
POP

BASEBOARDS

BASEBOARDS

Your look starts here – at the foundation of a room.

A great baseboard complements a casing and creates a smooth transition from the wall to the floor, guiding you seamlessly from room to room.



Stock Code Dimensions
713 3/16" x 3 1/4" x RL
PIN



Stock Code Dimensions
7230 7/16" x 3 1/4" x RL
O

7250 3/8" x 3" x RL
O



Stock Code Dimensions
713P 3/16" x 3 1/4" x 16'
FPP

723L 7/16" x 3 1/4" x RL
PIN

723LP 3/8" x 3 1/4" x 16'
FPP

724L 7/16" x 3" x RL
PIN

7260 3/8" x 2 3/4" x RL
O

BASEBOARDS

Stock Code Dimensions

61 $\frac{1}{2}$ " x $4\frac{1}{4}$ " x 16'
PIN

430J $\frac{7}{16}$ " x $4\frac{1}{4}$ " x 16'
FJP

430LM $\frac{5}{8}$ " x $5\frac{1}{2}$ " x 16'
MDF/UL

430M $\frac{5}{8}$ " x $4\frac{1}{4}$ " x 16'
MDF/UL

430SM $\frac{1}{2}$ " x $4\frac{1}{4}$ " x 16'
MDF/UL

431POP $1\frac{1}{32}$ " x $2\frac{3}{4}$ " x 16'
POP

432L $\frac{9}{16}$ " x $5\frac{1}{2}$ " x 16'
PIN

433LM $\frac{1}{2}$ " x $3\frac{1}{4}$ " x 16'
MDF/UL

433LPOP $\frac{7}{16}$ " x $3\frac{1}{4}$ " x 16'
POP

9135PRI $\frac{3}{8}$ " x $3\frac{1}{4}$ " x 16'
PRI

9144POP $\frac{3}{8}$ " x $4\frac{1}{4}$ " x 16'
POP

9144PRI $\frac{3}{8}$ " x $4\frac{1}{4}$ " x 16'
PRI

9145PRI $1\frac{1}{16}$ " x $4\frac{1}{4}$ " x 16'
PRI



Stock Code Dimensions
434M $\frac{1}{2}$ " x $7\frac{1}{4}$ " x 16'
MDF/UL



Stock Code Dimensions
431J $\frac{7}{16}$ " x $5\frac{1}{4}$ " x 16'
FPP



Stock Code Dimensions
431M $\frac{1}{2}$ " x $5\frac{1}{4}$ " x 16'
MDF/UL



Stock Code Dimensions
432LM $\frac{9}{16}$ " x $5\frac{1}{2}$ " x 16'
MDF/UL



Stock Code Dimensions
20140 $\frac{7}{16}$ " x $4\frac{1}{4}$ " x 16'
O

BASEBOARDS

BASEBOARDS

BASEBOARDS

Stock Code	Dimensions
623	7/16" x 3 1/4" x 16' PIN
623F16	7/16" x 3 1/4" x 16' PIN
623J	7/16" x 3 1/4" x 16' FPP
623M	1/2" x 3 1/4" x 16' MDF/UL
623MDF	1/2" x 3 1/4" x 16' MDF/UL
633L	7/16" x 3 1/4" x 16' PIN
633LJ	3/8" x 3 1/4" x 16' FPP
633L0	7/16" x 3 1/4" x 16' 0
635CE	5/16" x 2 3/4" x 14' PEC
634L	7/16" x 3" x 16' PIN

Stock Code	Dimensions
634LFJ	7/16" x 3" x 16' FJP
634LJ	7/16" x 3" x 16' FPP
634LPOP	3/8" x 3" x 16' POP
634M	1/2" x 3" x 16' MDF/UL
635MAP	3/8" x 2 3/4" x 16' MAP
6350	3/8" x 2 3/4" x 16' 0
635POP	3/8" x 2 3/4" x 16' POP
636SO	3/8" x 3" x 16' 0
637SO	3/8" x 3 1/4" x 16' 0
9121PRI	3/8" x 2 3/4" x 16' PRI
9130PRI	1/2" x 3 1/4" x 16' PRI

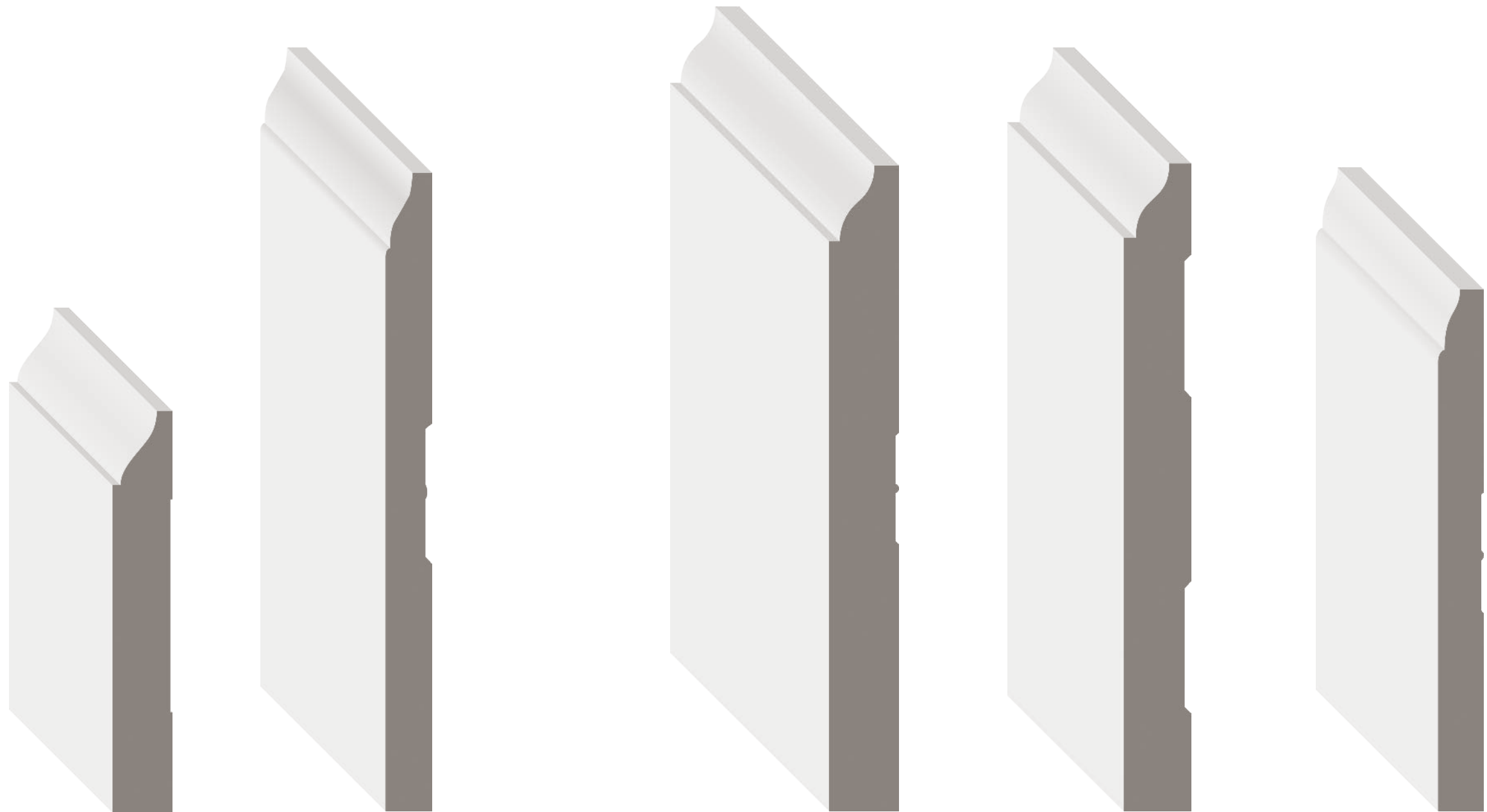

Stock Code	Dimensions
9157PRI	3/8" x 5 3/16" x 16' PRI

Stock Code	Dimensions
618	7/16" x 5 1/4" x 16' PIN

Stock Code	Dimensions
618J	7/16" x 5 1/4" x 16' FPP
618M	1/2" x 5 1/4" x 16' MDF/UL

Stock Code	Dimensions
9140POP	1/2" x 4 1/4" x 16' POP
9140PRI	1/2" x 4 1/4" x 16' PRI

BASEBOARDS

BASEBOARDS



Stock Code Dimensions
620LM 1/2" x 4 1/4" x 16'
 MDF/UL

620LMDF 1/2" x 4 1/4" x 16'
 MDF/UL

6200 7/16" x 4 1/4" x RL
 O



Stock Code Dimensions
620 7/16" x 4 1/4" x RL
 PIN

620J 7/16" x 4 1/4" x 16'
 FPP



Stock Code Dimensions
658 7/16" x 5 1/4" x RL
 PIN

658FJ 7/16" x 5 1/4" x RL
 FJP



Stock Code Dimensions
663J 7/16" x 3" x RL
 FPP

663M 1/2" x 3 1/4" x RL
 MDF/UL



Stock Code Dimensions
660J 7/16" x 4 1/4" x RL
 FPP

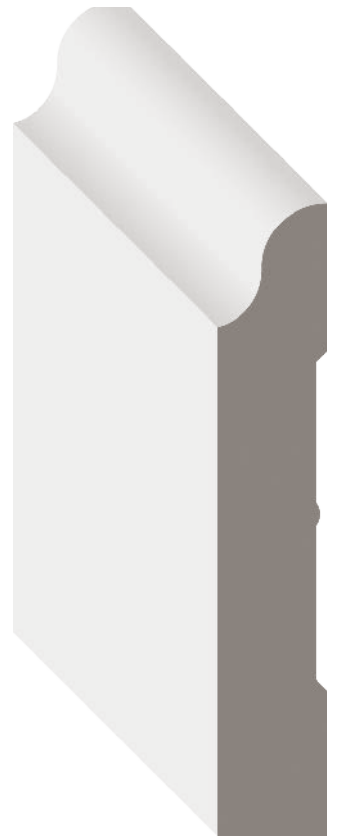

Stock Code Dimensions
663 7/16" x 3 1/4" x RL
 PIN

BASEBOARDS

BASEBOARDS



Stock Code	Dimensions
2808J	7/16" x 4 1/4" x 16' FPP
28080	7/16" x 4 1/4" x RL O
2813J	7/16" x 5 1/4" x 16' FPP
28130	7/16" x 5 1/4" x RL O
2813POP	7/16" x 5 1/4" x RL POP
9153PRI	7/16" x 5 1/4" x RL PRI



Stock Code	Dimensions
2805J	7/16" x 3 1/4" x 16' FPP



Stock Code	Dimensions
20232CBM	5/8" x 7 1/4" x RL MDF/UL



Stock Code	Dimensions
554M	1/2" x 4 1/2" x RL MDF/UL



Stock Code	Dimensions
9142PRI	7/16" x 4 1/4" x RL PRI

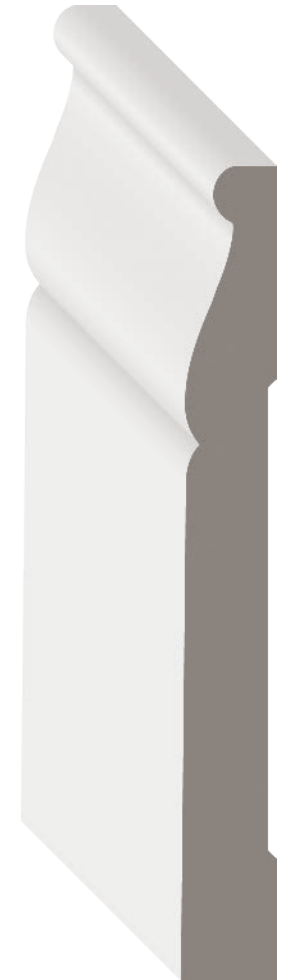

Stock Code	Dimensions
9143PRI	1/2" x 4 1/4" x RL PRI

BASEBOARDS

BASEBOARDS

Stock Code	Dimensions
9141POP	5/8" x 4 1/4" x RL POP
9141PRI	5/8" x 4 1/4" x RL PRI
9151POP	5/8" x 5 1/4" x RL POP
9151PRI	5/8" x 5 1/4" x RL PRI
9171POP	5/8" x 7 1/4" x RL POP
9171PRI	5/8" x 7 1/4" x RL PRI
20104CBM	1/16" x 3 1/4" x 16' MDF/UL

Stock Code	Dimensions
22136CB	1 1/16" x 4 1/4" x RL PIN
20136CBMDF	5/8" x 4 1/4" x 16' MDF/UL
20136CBM	5/8" x 4 1/4" x 16' MDF/UL
22136CBO	1 1/16" x 4 1/4" x RL O
22168CB	1 1/16" x 5 1/4" x RL PIN
20168CBM	5/8" x 5 1/4" x RL MDF/UL
22168CBO	1 1/16" x 5 1/4" x RL O
22232CBO	1 1/16" x 7 1/4" x RL O



Stock Code Dimensions
759P 1/16" x 4 3/4" x 16'
FPP



Stock Code Dimensions
163E7M 5/8" x 7 1/4" x 16'
MDF/UL
163EM 5/8" x 5 1/4" x 16'
MDF/UL



Stock Code Dimensions
163EMDF 5/8" x 5 1/4" x 16'
MDF/UL



Stock Code Dimensions
9158PRI 5/8" x 5 1/4" x RL
PRI



Stock Code Dimensions
647FJ 1/16" x 5 1/4" x RL
FJP



BASEBOARDS



Stock Code Dimensions
20168EBM 5/8" x 5 1/4" x 16'
 MDF/UL

22168EBO 1 1/16" x 5 1/4" x RL
 O

Stock Code Dimensions
9152POP 5/8" x 5 1/4" x RL
 POP

9152PRI 5/8" x 5 1/4" x RL
 PRI

Stock Code Dimensions
20232EBM 5/8" x 7 1/4" x 16'
 MDF/UL

Stock Code Dimensions
9172POP 5/8" x 7 1/4" x RL
 POP

9172PRI 5/8" x 7 1/4" x RL
 PRI



BASEBOARDS



Stock Code Dimensions
207M 5/8" x 7 1/4" x 16'
 MDF/UL



Stock Code Dimensions
8263M 5/8" x 6 1/2" x RL
 MDF/UL



Stock Code Dimensions
526M 5/8" x 5 1/4" x 16'
 MDF/UL



Stock Code Dimensions
545M 5/8" x 5" x 16'
 MDF/UL

BASEBOARDS



Stock Code	Dimensions
2009	3/16" x 5 1/4" x RL PIN
2009J	3/16" x 5 1/4" x 16' FJP
2009O	3/16" x 5 7/16" x RL O
2009POP	3/16" x 5 7/16" x RL POP
2010	3/16" x 1 5/8" x RL PIN
2010O	3/16" x 1 3/4" x RL O

Stock Code	Dimensions
18136BPRI	3/16" x 4 1/4" x 16' PRI
18136TBPRI	3/16" x 4 5/16" x 16' PRI
18168BPRI	3/16" x 5 1/4" x 16' PRI
18232BPOP	3/16" x 7 7/16" x RL POP

BASEBOARDS



Stock Code	Dimensions
9283M	1 3/16" x 7 1/4" x RL MDF/UL

Stock Code	Dimensions
9263M	1 1/16" x 7 1/16" x RL MDF/UL

Stock Code	Dimensions
20160BM	5/8" x 5" x 16' MDF/UL

Stock Code	Dimensions
412M	3/16" x 4 1/4" x RL MDF/UL

BASEBOARD CAPS & SHOES

Baseboard caps are added to the top of regular baseboard moulding and flush to the wall to create a finished and more complex architectural moulding. Baseboard shoes are primarily used to trim flooring materials and are often used in combination with a traditional baseboard to conceal variations between the flooring and the base. However, this versatile profile works great to solve numerous trimming needs.

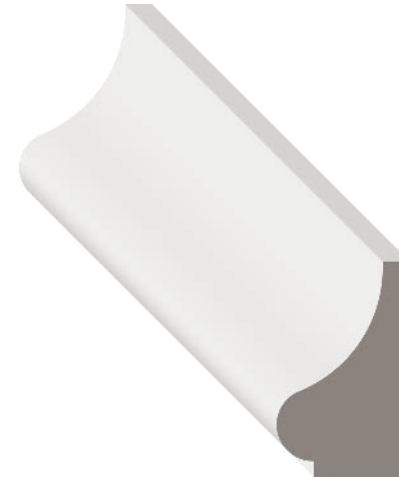

Stock Code Dimensions
167P $1\frac{1}{16}'' \times 1\frac{1}{8}'' \times 16'$
FPP



Stock Code Dimensions
166L $1\frac{1}{16}'' \times 1\frac{1}{4}'' \times 16'$
PIN

166P $5/8'' \times 1\frac{1}{4}'' \times 16'$
FPP

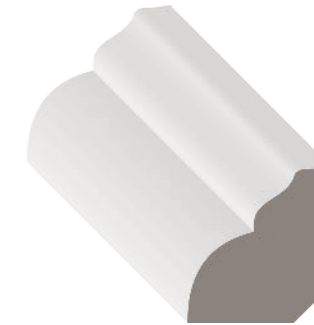

Stock Code Dimensions
9602PRI $3/4'' \times 1\frac{3}{16}'' \times 16'$
PRI



Stock Code Dimensions
890POP $1\frac{1}{32}'' \times 7/8'' \times 16'$
POP

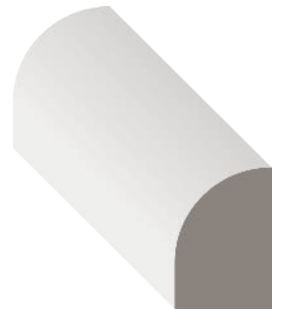

Stock Code Dimensions
129 $7/16'' \times 1\frac{1}{16}'' \times 16'$
PIN

Stock Code Dimensions
126F08 $1/2'' \times 3/4'' \times 8'$
PIN

129P $7/16'' \times 1\frac{1}{16}'' \times 16'$
FPP

126J $1/2'' \times 3/4'' \times 16'$
FPP

9601PRI $1/2'' \times 3/4'' \times 16'$
PRI

126MAP $1/2'' \times 3/4'' \times 16'$
MAP

126 $1/2'' \times 3/4'' \times 16'$
PIN

1260 $1/2'' \times 3/4'' \times 16'$
O

126C $1/2'' \times 3/4'' \times 16'$
CHR

126P $1/2'' \times 3/4'' \times 16'$
FPP

126CE $7/16'' \times 1\frac{1}{16}'' \times 14'$
PEC

126POP $1/2'' \times 3/4'' \times 16'$
POP



Stock Code Dimensions
163M $1\frac{1}{16}'' \times 1\frac{3}{8}'' \times 16'$
MDF/UL

163P $1\frac{1}{16}'' \times 1\frac{3}{8}'' \times 16'$
FPP

2244BCAPP $1\frac{1}{16}'' \times 1\frac{3}{8}'' \times 16'$
POP



Stock Code Dimensions
2148CBPOP $1\frac{1}{16}'' \times 1\frac{1}{2}'' \times 16'$
POP



Stock Code Dimensions
18P $5/8'' \times 1\frac{1}{16}'' \times 16'$
FPP



Stock Code Dimensions
622BAPOP $3/4'' \times 1\frac{1}{2}'' \times 16'$
POP



Stock Code Dimensions
2010POP $7/16'' \times 1\frac{3}{4}'' \times 16'$
POP

CASINGS

Casings bring a room together – left to right, top to bottom. And like any framing element, the options are endless, from build-ups of multiple pieces to full wraps. With casings, there's no wrong way, only your way.



Stock Code **324** Dimensions **1 1/16" x 2 1/4" x RL**
PIN

Stock Code **324F07** Dimensions **1 1/16" x 2 1/4" x 7'**
PIN

Stock Code **324LO** Dimensions **7/16" x 2 1/4" x RL**
O



Stock Code **324LOF07** Dimensions **7/16" x 2 1/4" x 7'**
O

Stock Code **324LPOP** Dimensions **7/16" x 2 1/4"**
POP

Stock Code **324LPOP07** Dimensions **7/16" x 2 1/4" x 7'**
POP



Stock Code **327** Dimensions **1 1/16" x 2 1/4" x RL**
PIN

Stock Code **327F07** Dimensions **1 1/16" x 2 1/4" x 7'**
PIN

Stock Code **327J** Dimensions **1 1/16" x 2 1/4" x RL**
FPP

Stock Code **327HO** Dimensions **9/16" x 2 1/4" x RL**
O

Stock Code **327HOF07** Dimensions **9/16" x 2 1/4" x 7'**
O

Stock Code **329L** Dimensions **9/16" x 2 3/4" x RL**
PIN

Stock Code **329LI90** Dimensions **9/16" x 2 3/4" x 90"**
PIN

Stock Code **3300** Dimensions **1/2" x 2 3/4" x RL**
O



Stock Code **682M** Dimensions **1" x 3 1/4" x RL**
MDF/UL



Stock Code **420M** Dimensions **1 1/16" x 2 3/4" x RL**
MDF/UL

Stock Code **421M** Dimensions **1 1/16" x 3 1/4" x RL**
MDF/UL

Stock Code **421MI90** Dimensions **1 1/16" x 3 1/4" x 90"**
MDF/UL



Stock Code **413LO** Dimensions **3/4" x 3 1/4" x RL**
O

Stock Code **413LOI86** Dimensions **3/4" x 3 1/4" x 86"**
O

Stock Code **413LPOP** Dimensions **3/4" x 3 1/4" x RL**
POP

Stock Code **413LPOPI86** Dimensions **3/4" x 3 1/4" x 86"**
POP

Stock Code **413LPRI** Dimensions **3/4" x 3 1/4" x 14' 6"**
PRI

Stock Code	Dimensions
472	5/16" x 2 1/2" x RL PIN
472FJ	5/16" x 2 1/2" x 16' FJP
472J	5/16" x 2 1/2" x 16' FPP
472M	5/8" x 2 1/2" x 14' MDF/UL
472MF08	5/8" x 2 1/2" x 8' MDF/UL
473J	5/16" x 2 1/4" x 14' FPP
473LM	5/8" x 2 1/4" x 16' MDF/UL
473LMDF	5/8" x 2 1/4" x 16' MDF/UL

Stock Code	Dimensions
473LMF07	5/8" x 2 1/4" x 7' MDF/UL
473MAP	5/16" x 2 1/4" x RL MAP
473POP	5/16" x 2 1/4" x RL POP
473POPF07	5/16" x 2 1/4" x 7' POP
473PRI	5/16" x 2 1/4" x 14' PRI
473PRIF07	5/16" x 2 1/4" x 7' PRI
492	3/8" x 2 7/16" x RL PIN
9025PRI	5/8" x 2 1/2" x RL PP



Stock Code	Dimensions
433	5/16" x 3 1/4" x RL PIN
433FJ	5/16" x 3 1/4" x RL FJP
9933PRI	1/2" x 3 1/2" x 15' PRI

Stock Code	Dimensions
471LM	5/8" x 2 3/4" x 16' MDF/UL

Stock Code	Dimensions
1015SM	5/8" x 3 1/2" x 16' MDF/UL

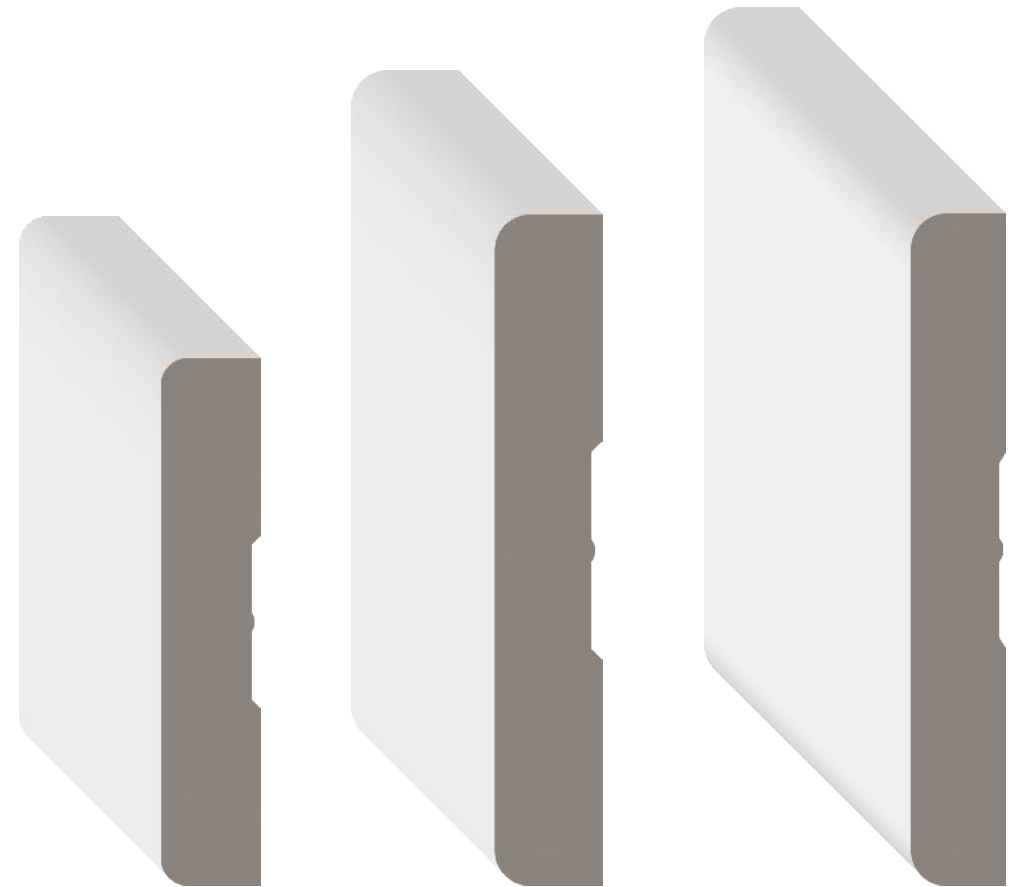

Stock Code	Dimensions
432	5/16" x 3 1/2" x RL PIN
432J	5/16" x 3 1/2" x 16' FPP
432LO	7/16" x 3 1/2" x RL O
432LOI90	7/16" x 3 1/2" x 90" O
432LPOP	7/16" x 3 1/2" x RL POP

Stock Code	Dimensions
432LPOPI90	7/16" x 3 1/2" x 90" POP
432M	1/2" x 3 1/2" x 16' MDF/UL
432P	5/16" x 3 1/2" x 16' FPP
433RPRI	7/16" x 3 1/4" x 16' PRI

Stock Code	Dimensions	Stock Code	Dimensions	Stock Code	Dimensions
351	1 1/16" x 2 1/2" x RL PIN	356JF07	1 1/16" x 2 1/4" x 7' FPP	356X0	5/8" x 2 1/4" x RL 0
3510	3/16" x 2 1/2" x RL 0	356LCE	7/16" x 2 1/4" x 14' PEC	356X0F07	5/8" x 2 1/4" x 7' 0
355	3/16" x 2 3/4" x RL PIN	356LCEF07	7/16" x 2 1/4" x 7' PEC	3580	3/16" x 2 1 1/16" x RL 0
355I90	3/16" x 2 3/4" x 90" PIN	356M	5/8" x 2 1/4" x 14' MDF/UL	3580I90	3/16" x 2 1 1/16" x 90" 0
356	1 1/16" x 2 1/4" x RL PIN	356MDF	5/8" x 2 1/4" x 14' MDF/UL	456CE	1 9/32" x 2 1/4" x RL PEC
356F07	1 1/16" x 2 1/4" x 7' PIN	356MDF07	5/8" x 2 1/4" x 7' MDF/UL	456CEF07	1 9/32" x 2 1/4" x 7' PEC
356FJ	1 1/16" x 2 1/4" x RL FJP	356MF07	5/8" x 2 1/4" x 7' MDF/UL	9000POP	3/16" x 2 1/4" x RL POP
356FJF07	1 1/16" x 2 1/4" x 7' FJP	356SO	7/16" x 2 1/4" x RL 0	9000POPF07	3/16" x 2 1/4" x 7' POP
356J	1 1/16" x 2 1/4" x 14' FPP	356SOF07	7/16" x 2 1/4" x 7' 0	9000PRI	3/16" x 2 1/4" x 14' FPP
				9000PRIF07	3/16" x 2 1/4" x 7' PRI

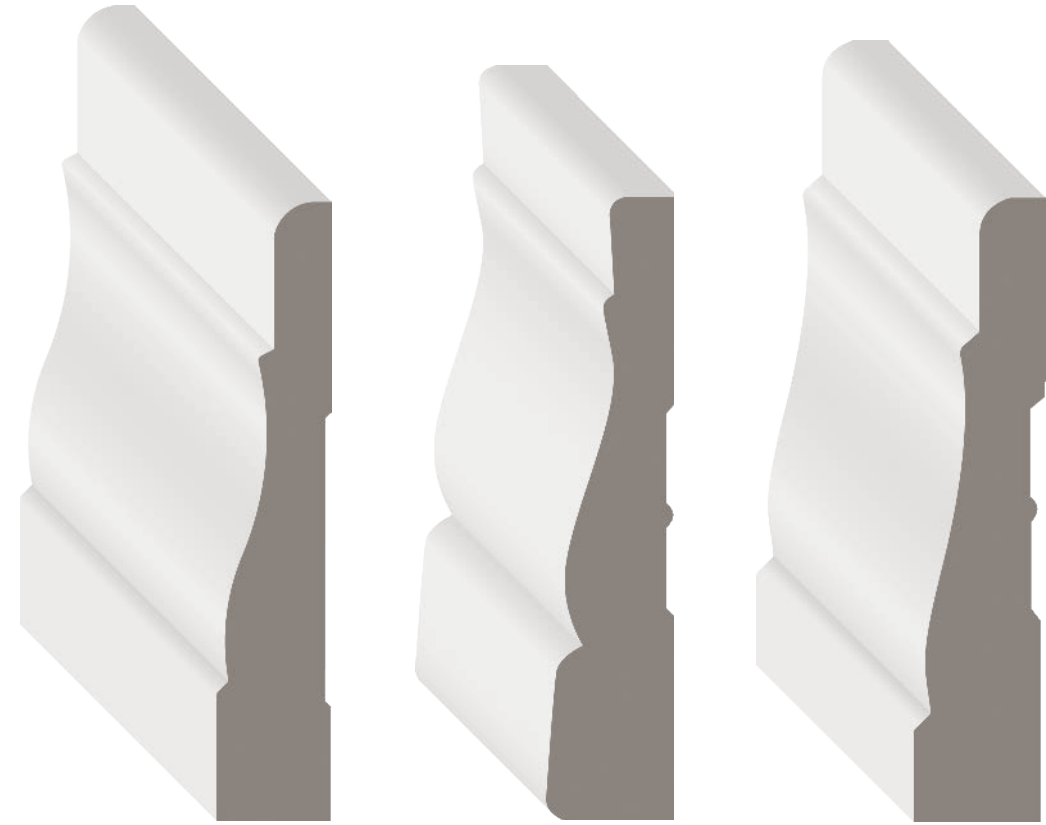

Stock Code	Dimensions	Stock Code	Dimensions	Stock Code	Dimensions	Stock Code	Dimensions
9037PRI	5/8" x 3 1/4" x 16' PRI	4440	5/8" x 3 1/4" x RL 0	444	1 1/16" x 3 1/2" x RL PIN	444LM	1 1/16" x 3 1/4" x 16' MDF/UL
9037PRII90	5/8" x 3 1/4" x 90" PRI	4440I90	5/8" x 3 1/4" x 90" 0	444L	1 1/16" x 3 1/4" x RL PIN	444LMI90	1 1/16" x 3 1/4" x 90" MDF/UL
				444LI90	1 1/16" x 3 1/4" x 90" PIN	444NFJ	1 1/16" x 3 1/4" x 16' FJP
				444LJ	1 1/16" x 3 1/4" x 16' FPP	444NP	1 1/16" x 3 1/4" x 16' FPP
				444LJI90	1 1/16" x 3 1/4" x 90" FPP		



Stock Code Dimensions
368MAP 1/2" x 2 1/4" x RL
MAP

368MAPF07 1/2" x 2 1/4" x 7'
MAP

368POP 1/2" x 2 1/4" x RL
POP

368POPF07 1/2" x 2 1/4" x 7'
POP



Stock Code Dimensions
367M 3/4" x 2 1/4" x 16'
MDF/UL



Stock Code Dimensions
332 1 1/16" x 2 1/4" x RL
PIN

332F07 1 1/16" x 2 1/4" x 7'
PIN



Stock Code Dimensions
9832PRI 3/4" x 3 1/2" x 16'
PRI

9832PRII90 3/4" x 3 1/2" x 90"
PRI



Stock Code Dimensions
4390 5/8" x 3 7/16" x RL
0

4390I90 5/8" x 3 7/16" x 90"
0



Stock Code Dimensions
448P 1 1/16" x 3 1/4" x 16'
FPP



Stock Code Dimensions
130P 1 1/16" x 3 1/2" x RL
FPP



Stock Code Dimensions
445J 1 1/16" x 3 1/4" x 16'
FPP

445JI87 1 1/16" x 3 1/4" x 87"
FPP

445LMDF 3/4" x 3 1/4" x 16'
MDF/UL

445LMDF 3/4" x 3 1/4" x 16'
MDF/UL

445LMDF08 3/4" x 3 1/4" x 8'
MDF/UL

445LMF08 3/4" x 3 1/4" x 8'
MDF/UL



Stock Code Dimensions
9923PRI 5/8" x 2 1/4" x 14'
PRI

9923PRIF07 5/8" x 2 1/4" x 7'
PRI



Stock Code Dimensions
364J 5/8" x 3 1/4" x 16'
FPP

364JI88 5/8" x 3 1/4" x 88"
FPP



Stock Code Dimensions
360LP 5/8" x 3 1/4" x 16'
FPP



Stock Code Dimensions
9931PRI 5/8" x 3 1/2" x 15'
PRI

9931PRII90 5/8" x 3 1/2" x 90"
PRI



Stock Code Dimensions
449 1 1/16" x 3 1/2" x RL
PIN

449J 1 1/16" x 3 1/2" x RL
FPP



Stock Code Dimensions
9036PRI 3/4" x 3 1/2" x 16'
PRI



Stock Code Dimensions
366 1 1/16" x 2 1/4" x RL
PIN

366F07 1 1/16" x 2 1/4" x 7'
PIN

366J 1 1/16" x 2 1/4" x RL
FPP

366JI86 1 1/16" x 2 1/4" x 86"
FPP

Stock Code Dimensions
366M 5/8" x 2 1/4" x 14'
MDF/UL

366MI85 5/8" x 2 1/4" x 85"
MDF/UL

366MDF 5/8" x 2 1/4" x 14'
MDF/UL

366MDFI85 5/8" x 2 1/4" x 85"
MDF/UL

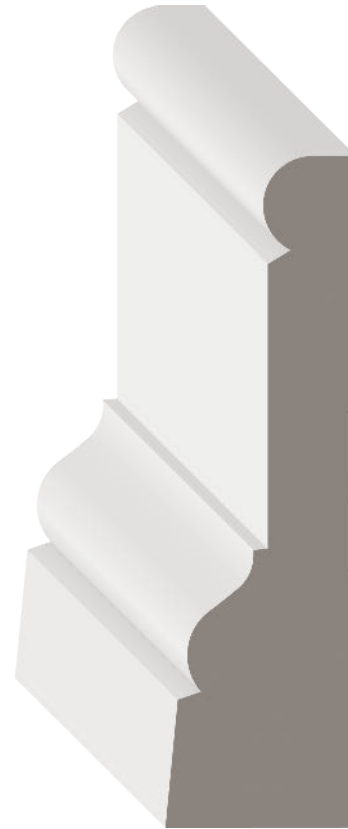

Stock Code	Dimensions
9031POP	1¹/₁₆" x 3¹/₂" x 16' POP
9031POPI90	1¹/₁₆" x 3¹/₂" x 90" POP
9031PRI	1¹/₁₆" x 3¹/₂" x 16' PRI

Stock Code	Dimensions
9031PRII90	1¹/₁₆" x 3¹/₂" x 90" PRI
24112CCAM	3/4" x 3¹/₂" x RL MDF/UL
24112CCLJ	5/8" x 3¹/₂" x RL FPP

Stock Code	Dimensions
9022PRI	3/4" x 2³/₄" x 15' PRI
9022PRII90	3/4" x 2³/₄" x 90" PRI

Stock Code	Dimensions
97M	1" x 3¹/₂" x 16' MDF/UL

Stock Code	Dimensions
18M112ULCAM	1¹/₁₆" x 3¹/₂" x RL MDF/UL

Stock Code	Dimensions
446LO	1¹/₁₆" x 3¹/₂" x 16' O
9038PRI	1¹/₁₆" x 3¹/₂" x RL PP

Stock Code	Dimensions
9831PRI	1¹/₁₆" x 3¹/₄" x 16' PRI
9831PRII90	1¹/₁₆" x 3¹/₄" x 90" PRI

Stock Code	Dimensions
1002PRI	3/4" x 3" x 15' PRI



Stock Code Dimensions
9024PRI 3/4" x 2 1/2" x 15'
PRI



Stock Code Dimensions
9021PRI 3/4" x 2 15/16" x 15'
PRI



Stock Code Dimensions
350LJ 5/8" x 3 1/2" x RL
FPP



Stock Code Dimensions
8063M 3/4" x 3 1/4" x 16'
MDF/UL



Stock Code Dimensions
411M 1 1/16" x 3" x 16'
MDF/UL



Stock Code Dimensions
474J 1 1/16" x 2 3/4" x 15'
FPP

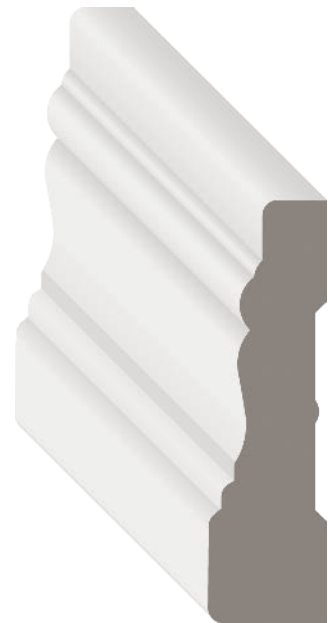

Stock Code Dimensions
347FJ $\frac{5}{8}$ " x 2¼" x RL
FJP



Stock Code Dimensions
535M $\frac{3}{4}$ " x 3½" x 16'
MDF/UL



Stock Code Dimensions
24112CCA0 $\frac{3}{4}$ " x 3½" x RL
O



Stock Code Dimensions
32112CAM 1" x 3½" x 16'
MDF/UL



Stock Code Dimensions
215M $\frac{3}{4}$ " x 3½" x 16'
MDF/UL



Stock Code Dimensions
215PRI $\frac{1}{16}$ " x 3½" x 16'
PRI

Stock Code Dimensions
9034PRI 1³/₁₆" x 3¹/₂" x RL
PRI

.....
9035POP 1¹/₁₆" x 3¹/₂" x RL
PP

.....
9035POPI90 1¹/₁₆" x 3¹/₂" x 90"
POP

.....
9035PRI 1¹/₁₆" x 3¹/₂" x 16'
PRI

.....
9035PRII90 1¹/₁₆" x 3¹/₂" x 90"
PRI

.....
 Stock Code Dimensions
24112PCAJ 1¹/₁₆" x 3¹/₂" x RL
FPP
24112PCAMDF 3/4" x 3¹/₂" x 16'
MDF/UL

.....
24112PCAJI90 1¹/₁₆" x 3¹/₂" x 90"
FPP
24112PCAMI102 1¹/₁₆" x 3¹/₂" x 102"
MDF/UL

.....
24112PCAJI102 1¹/₁₆" x 3¹/₂" x 102"
FPP
24112PCAO 3/4" x 3³/₁₆" x RL
0

.....
24112PCAM 3/4" x 3¹/₂" x RL
MDF/UL
24112PCA0I90 3/4" x 3³/₁₆" x 90"
0



Stock Code Dimensions
2496J 1¹/₁₆" x 3" x 16'
FPP

.....
2496JI90 1¹/₁₆" x 3" x 90"
FPP



Stock Code Dimensions
24960 3/4" x 3" x RL
0

.....
24960I90 3/4" x 3" x 90"
0

.....
2496PRI 3/4" x 3" x RL
PRI

.....
9041PRI 1¹/₁₆" x 4¹/₄" x 16'
PRI



Stock Code Dimensions
447FJ 1¹/₁₆" x 3¹/₄" x 16'
FJP



Stock Code Dimensions
9053M 1" x 4¹/₂" x 16'
MDF/UL



Stock Code Dimensions
9033PRI 3/4" x 3 1/2" x 16'
PRI



Stock Code Dimensions
24112ECAM 3/4" x 3 1/2" x 16'
MDF/UL



Stock Code Dimensions
24136ECAM 3/4" x 4 1/4" x 16'
MDF/UL



Stock Code Dimensions
523EM 1" x 3 1/4" x 16'
MDF/UL



Stock Code Dimensions
34136CAPOP 1 1/16" x 4 1/4" x RL
POP

34136CAPRI 1 1/16" x 4 1/4" x 15'
PRI



Stock Code Dimensions
9073M 1 3/8" x 4" x 16'
MDF/UL



Stock Code Dimensions
2488CAJ 1 1/16" x 2 3/4" x RL
FPP

.....
2488CAJ188 1 1/16" x 2 3/4" x 88"
FPP

.....
2488CAM 3/4" x 2 3/4" x RL
MDF/UL



Stock Code Dimensions
4596POP 3/4" x 3 1/4" x RL
POP



Stock Code Dimensions
194P 5/8" x 3 1/4" x RL
FPP

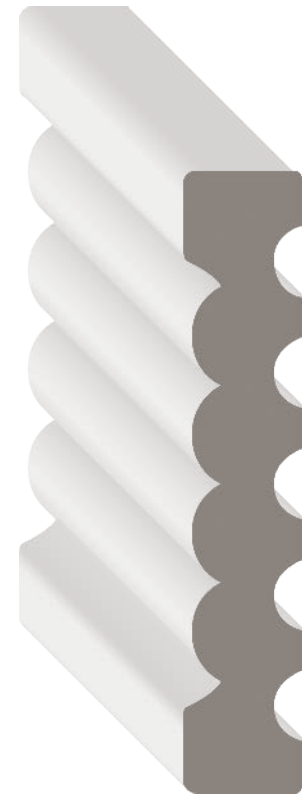

Stock Code Dimensions
908LM 5/8" x 3 1/4" x RL
MDF/UL



Stock Code Dimensions
4AVPOP 3/4" x 3 1/2" x RL
POP

.....
4AVPRI 3/4" x 3 1/2" x 16'
PRI



Stock Code Dimensions
24136RFCAFJP 3/4" x 4 1/4"
PRI



Stock Code Dimensions
24168FCAPOP 3/4" x 5 3/16"
POP

CHAIR RAILS

The chair rail runs along the wall, parallel with the baseboard. Adding a refined decor to any space, it's the subtle choice that makes a big impact. The chair rail perfectly complements a wainscot design.



Stock Code Dimensions
390 1 1/16" x 2 5/8" x RL
 PIN

Stock Code Dimensions
390MO 5/8" x 2 1/2" x RL
 O

Stock Code Dimensions
2288CHPOP 1 1/16" x 2 3/4" x RL
 POP

Stock Code Dimensions
200CHPOP 1 1/16" x 4 1/4" x RL
 POP

Stock Code Dimensions
32104CHM 1" x 3 3/4" x 16'
 MDF/UL

Stock Code Dimensions
5006POP 1 3/16" x 2 1/2" x RL
 POP

Stock Code Dimensions
22104CHPOP 1 1/16" x 3 3/4" x RL
 POP

Stock Code Dimensions
16104CHPOP 1/2" x 3 3/4" x RL
 POP

Stock Code Dimensions
390J 1 1/16" x 2 5/8" x 16'
 FPP

Stock Code Dimensions
390LPOP 5/8" x 2 1/2" x RL
 POP

Stock Code Dimensions
390LM 1 1/16" x 2 1/2" x 16'
 MDF/UL

Stock Code Dimensions
9320PRI 5/8" x 2 5/8" x 16'
 PRI

Stock Code Dimensions
32104CHP 1" x 3 3/4" x 16'
 FPP

Stock Code Dimensions
32104CHPOP 1" x 3 3/4" x RL
 POP

Stock Code Dimensions
32104CHPRI 1" x 3 3/4" x 16'
 PRI

COVES

Coves are commonly used to soften the transition on inside corners but may be used for a wide range of applications.

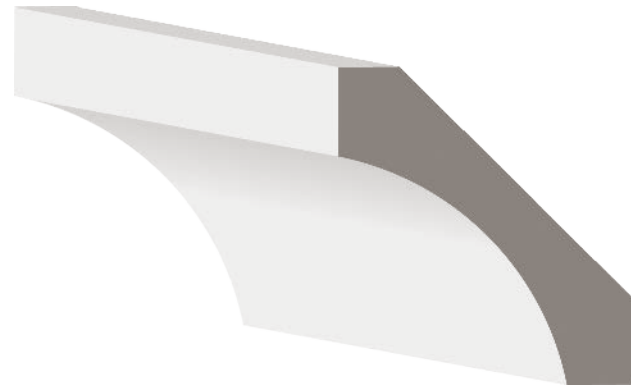

Stock Code Dimensions
84L $\frac{7}{16}'' \times 2\frac{1}{4}'' \times \text{RL}$
 PIN

85 $\frac{7}{16}'' \times 1\frac{3}{4}'' \times \text{RL}$
 PIN



Stock Code Dimensions
93 $\frac{3}{4}'' \times \frac{3}{4}'' \times \text{RL}$
 PIN

93F08 $\frac{3}{4}'' \times \frac{3}{4}'' \times 8'$
 PIN

93MAP $\frac{3}{4}'' \times \frac{3}{4}'' \times \text{RL}$
 MAP

930 $\frac{3}{4}'' \times \frac{3}{4}'' \times \text{RL}$
 O

93POP $\frac{3}{4}'' \times \frac{3}{4}'' \times \text{RL}$
 POP

93PRI $\frac{3}{4}'' \times \frac{3}{4}'' \times 16'$
 PRI

101 $\frac{1}{2}'' \times \frac{1}{2}'' \times \text{RL}$
 PIN



Stock Code Dimensions
90 $1\frac{1}{16}'' \times 1\frac{1}{8}'' \times \text{RL}$
 PIN



Stock Code Dimensions
100 $1\frac{1}{16}'' \times 1\frac{1}{16}'' \times \text{RL}$
 PIN

1000 $1\frac{1}{16}'' \times 1\frac{1}{16}'' \times \text{RL}$
 O

1010 $\frac{1}{2}'' \times \frac{1}{2}'' \times \text{RL}$
 O



Stock Code Dimensions
5012POP $\frac{3}{4}'' \times \frac{3}{4}'' \times \text{RL}$
 POP



Stock Code Dimensions
100F08 $1\frac{1}{16}'' \times 1\frac{1}{16}'' \times 8'$
 PIN

100P $1\frac{1}{16}'' \times 1\frac{1}{16}'' \times 16'$
 FPP



Stock Code Dimensions
96LPOP $\frac{1}{2}'' \times \frac{3}{4}'' \times \text{RL}$
 POP



Stock Code Dimensions
2024POP $\frac{5}{8}'' \times \frac{3}{4}'' \times \text{RL}$
 POP

CROWNS

Cap off your look with the perfect crown. A great crown is the royal wrap-up of all your moulding decisions.

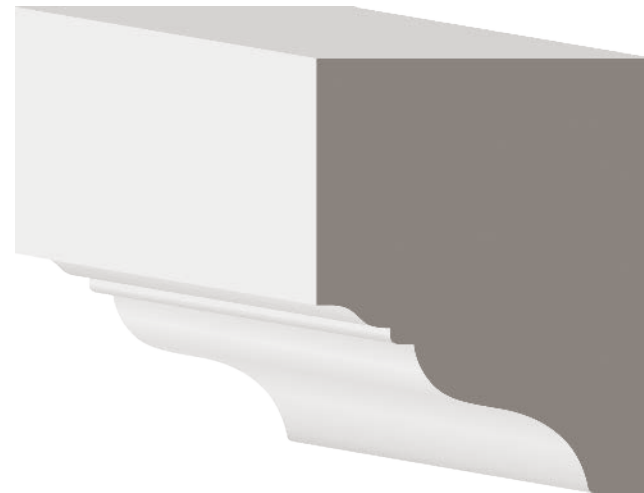

Stock Code Dimensions
150TCLPOP 1¾" x 2¼" x RL
POP

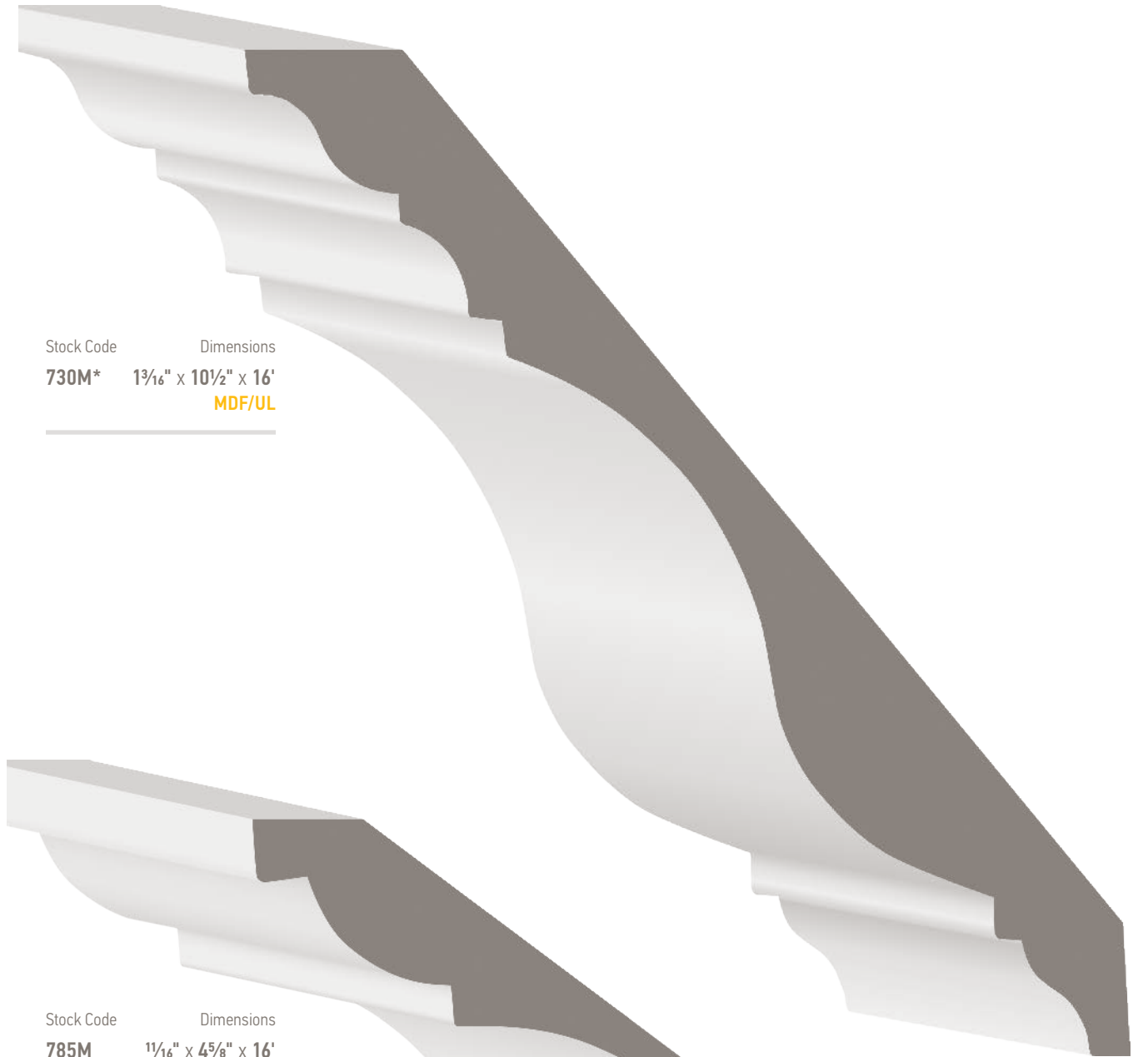

Stock Code Dimensions
730M* 1¾" x 10½" x 16'
MDF/UL

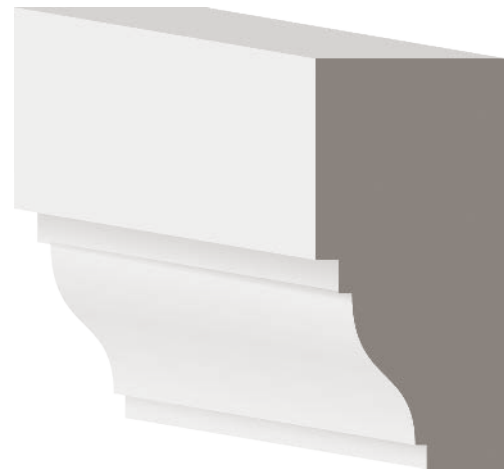

Stock Code Dimensions
140TCLM 1" x 2½" x RL
MDF/UL



Stock Code Dimensions
9520PRI 5⁄8" x 2¾" x 16'
PRI

140TCPOP 1" x 2½" x RL
POP

2480CBP 1½" x 2½" x 16'
FPP

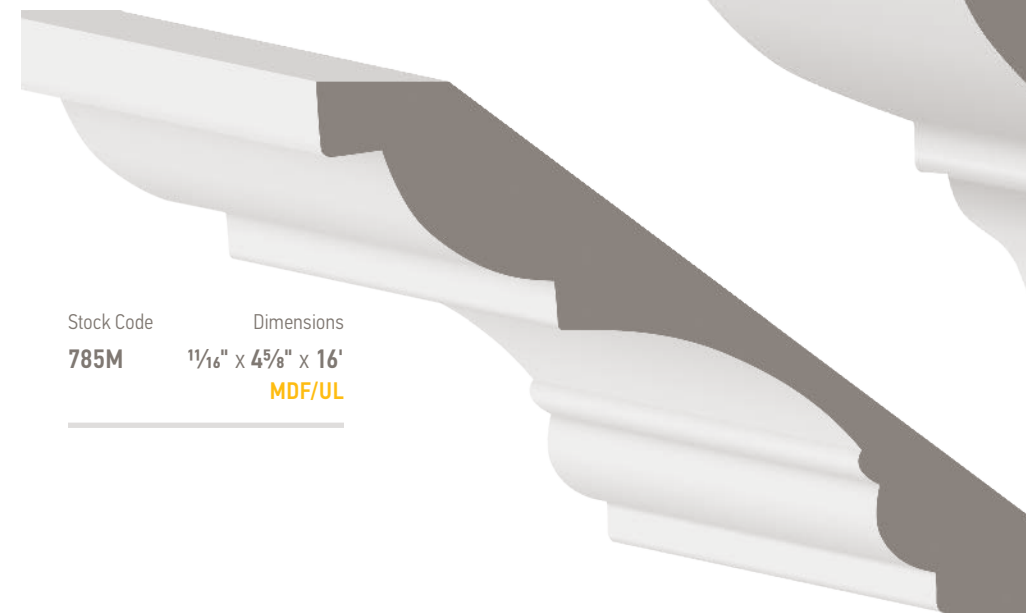

Stock Code Dimensions
785M 1½" x 4⅝" x 16'
MDF/UL

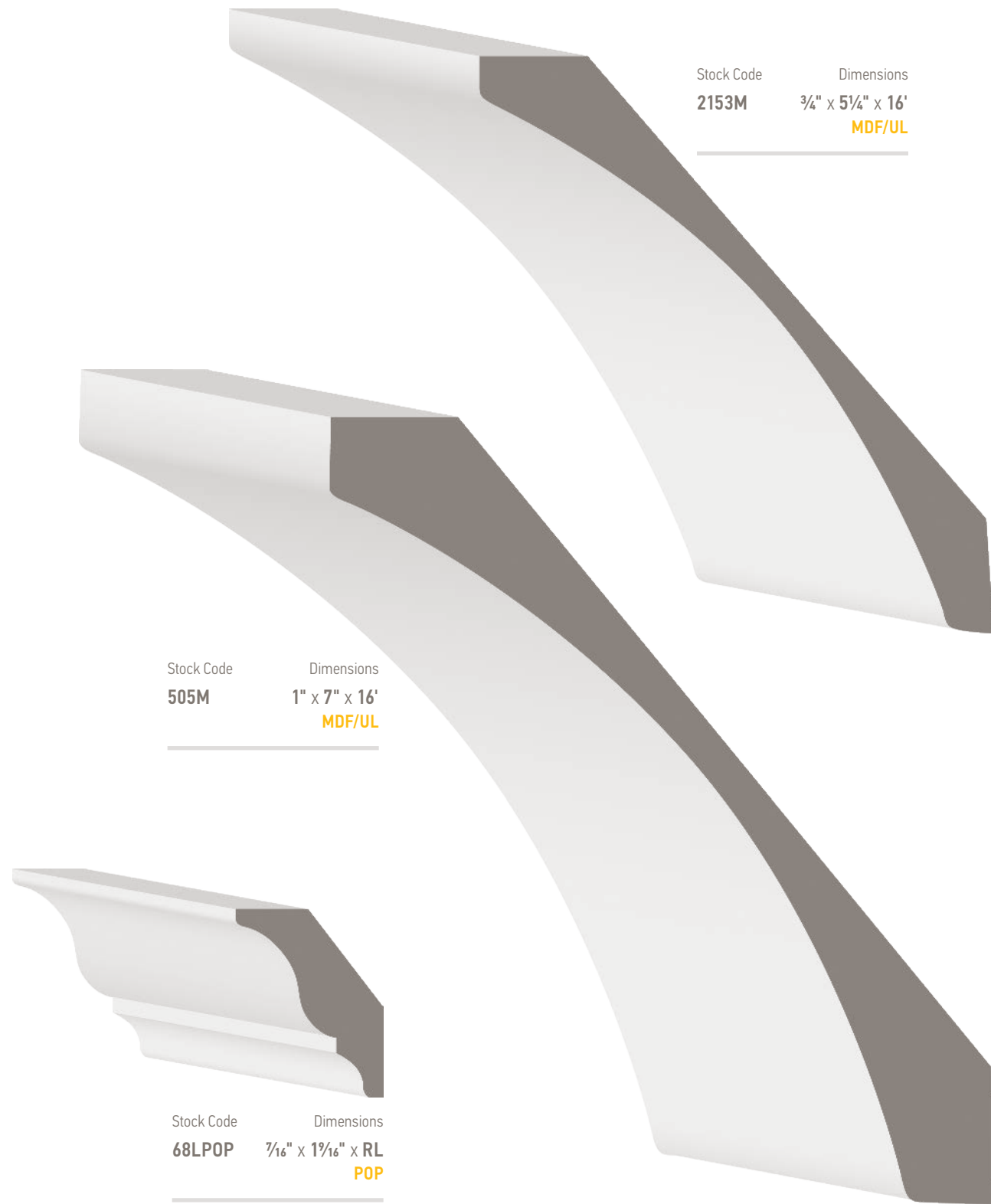

Stock Code **2153M** Dimensions $\frac{3}{4}'' \times 5\frac{1}{4}'' \times 16'$
MDF/UL

Stock Code **505M** Dimensions $1'' \times 7'' \times 16'$
MDF/UL

Stock Code **68LPOP** Dimensions $\frac{7}{16}'' \times 1\frac{1}{16}'' \times RL$
POP

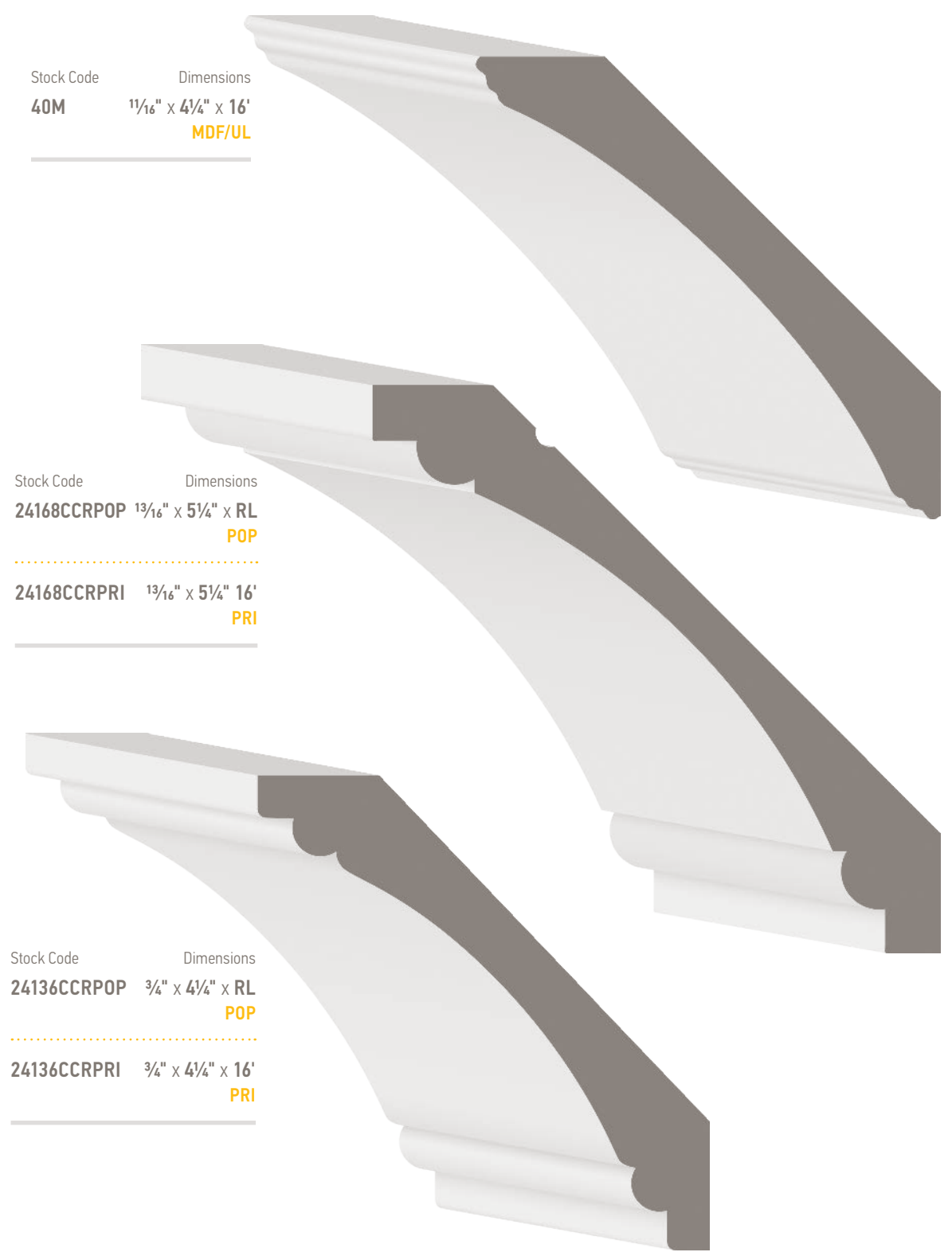

Stock Code **40M** Dimensions $1\frac{1}{16}'' \times 4\frac{1}{4}'' \times 16'$
MDF/UL

Stock Code **24168CCRPOP** Dimensions $1\frac{3}{16}'' \times 5\frac{1}{4}'' \times RL$
POP

24168CCRPRI $1\frac{3}{16}'' \times 5\frac{1}{4}'' \times 16'$
PRI

Stock Code **24136CCRPOP** Dimensions $\frac{3}{4}'' \times 4\frac{1}{4}'' \times RL$
POP

24136CCRPRI $\frac{3}{4}'' \times 4\frac{1}{4}'' \times 16'$
PRI

CROWNS

Stock Code	Dimensions
45L	$\frac{1}{16}$ " x $5\frac{3}{16}$ " x RL PIN
45LJ	$\frac{9}{16}$ " x $5\frac{1}{4}$ " x 16' FPP
45LM	$\frac{5}{8}$ " x $5\frac{1}{4}$ " x 16' MDF/UL
45LMDF	$\frac{5}{8}$ " x $5\frac{1}{4}$ " x 16' MDF/UL
9251POP	$\frac{5}{8}$ " x $5\frac{1}{4}$ " x RL POP
9251PRI	$\frac{5}{8}$ " x $5\frac{1}{4}$ " x 16' PRI
49M	$\frac{5}{8}$ " x $3\frac{5}{8}$ " x 16' MDF/UL
490	$\frac{3}{4}$ " x $3\frac{1}{16}$ " x RL O
9230POP	$\frac{1}{2}$ " x $3\frac{3}{16}$ " x RL POP
9230PRI	$\frac{1}{2}$ " x $3\frac{3}{16}$ " x 16' PRI
52	$\frac{9}{16}$ " x $2\frac{3}{4}$ " x RL PIN

CROWNS

Stock Code	Dimensions
43M	1" x $6\frac{15}{16}$ " x RL MDF/UL
34232BCRPOP	$1\frac{1}{16}$ " x $7\frac{3}{16}$ " x RL POP
47LJ	$\frac{9}{16}$ " x $4\frac{9}{16}$ " x 16' FPP
47M	$\frac{5}{8}$ " x $4\frac{5}{8}$ " x 16' MDF/UL
47MDF	$\frac{3}{4}$ " x $4\frac{5}{8}$ " x 16' MDF/UL
48L	$\frac{9}{16}$ " x $4\frac{1}{4}$ " x RL PIN
48LFJ	$\frac{9}{16}$ " x $4\frac{1}{4}$ " x 16' FJP
48LJ	$\frac{9}{16}$ " x $4\frac{1}{4}$ " x 16' FPP
48LM	$\frac{5}{8}$ " x $4\frac{1}{4}$ " x 16' MDF/UL
48LPOP	$\frac{5}{8}$ " x $4\frac{1}{4}$ " x RL POP
48LPRI	$\frac{5}{8}$ " x $4\frac{1}{4}$ " x 16' PRI
480	$1\frac{1}{16}$ " x $4\frac{1}{4}$ " x RL O
49L	$\frac{1}{2}$ " x $3\frac{5}{8}$ " x RL PIN
49LJ	$\frac{9}{16}$ " x $3\frac{5}{8}$ " x 16' FPP
9241PRI	$\frac{1}{2}$ " x $4\frac{1}{4}$ " x 16' PRI

CROWNS



Stock Code	Dimensions
450	1 3/16" x 5 1/4" x RL O
9250POP	1 1/16" x 5 1/4" x RL POP
9250PRI	1 1/16" x 5 1/4" x 16' PRI

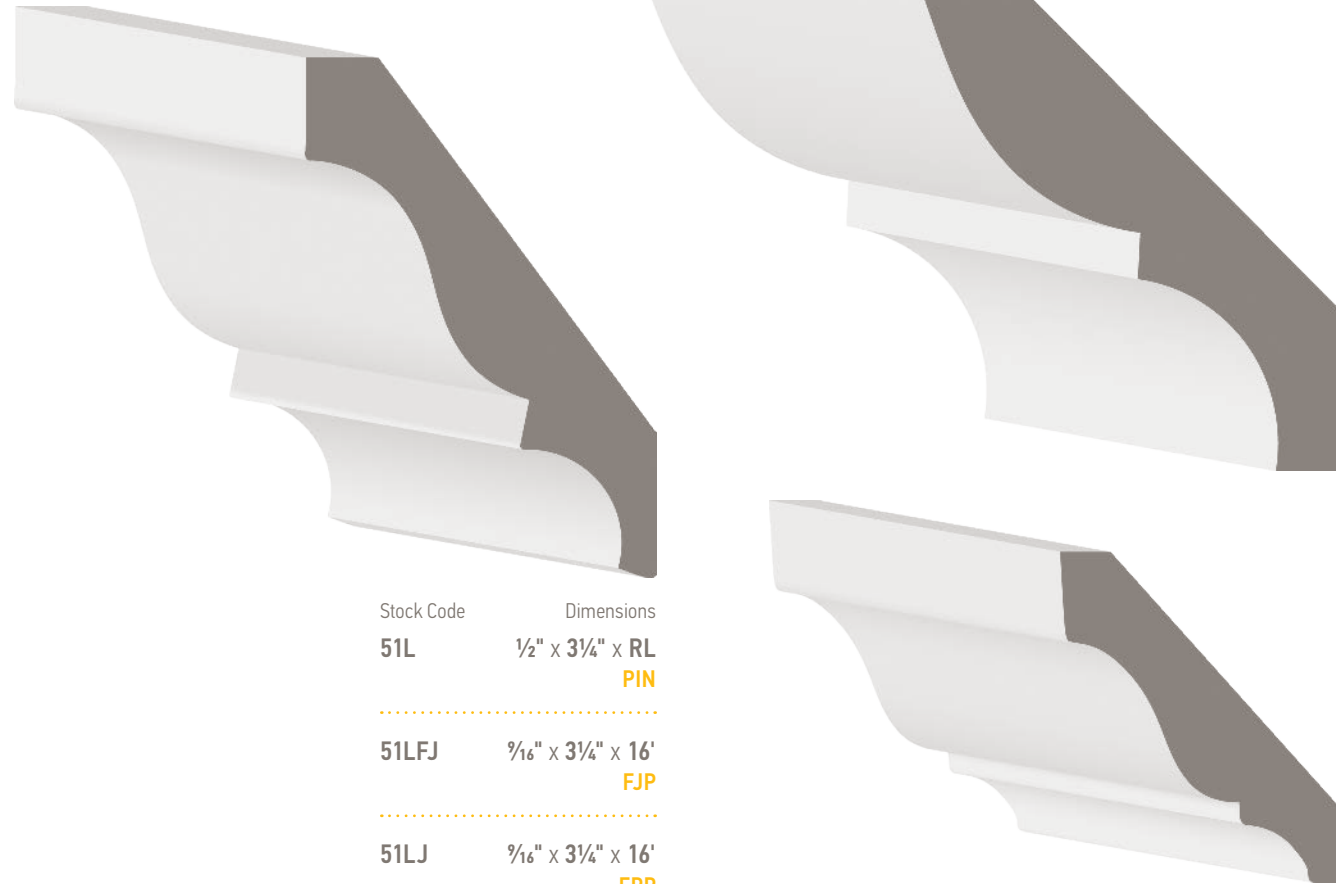

Stock Code	Dimensions
51L	1/2" x 3 1/4" x RL PIN
51LFJ	5/16" x 3 1/4" x 16' FJP
51LJ	5/16" x 3 1/4" x 16' FPP
51LM	5/8" x 3 1/4" x RL MDF/UL
51LO	5/8" x 3 1/4" x RL O
51LPOP	5/8" x 3 5/16" x RL POP

Stock Code	Dimensions
54	3/16" x 2 1/4" x RL PIN
54LO	1/2" x 2 1/4" x RL O
54P	3/16" x 2 1/4" x 16' FPP

CROWNS

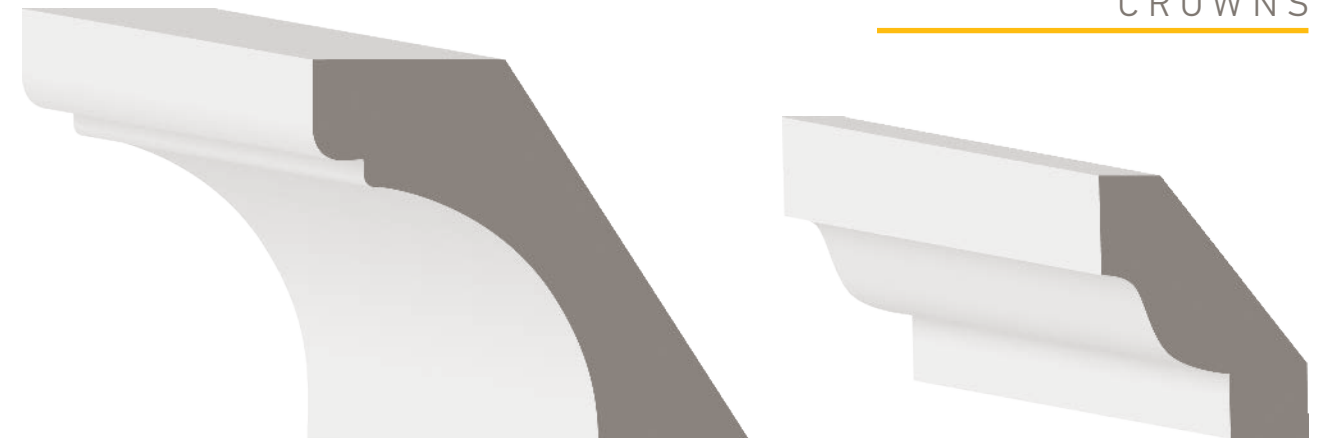

Stock Code	Dimensions
34232ACRM	1" x 7 1/4" x 16' MDF/UL
34232ACRPRI	1 1/16" x 7 1/4" x 16' PRI



Stock Code	Dimensions
60	3/16" x 1 3/4" x RL PIN
60P	3/16" x 1 3/4" x 16' FPP

Stock Code	Dimensions
24168QACRPRI	3/4" x 5 1/4" x 16' PRI

CROWNS



Stock Code Dimensions
32242CRM $\frac{7}{8}" \times 7\frac{1}{4}" \times 16'$
 MDF/UL

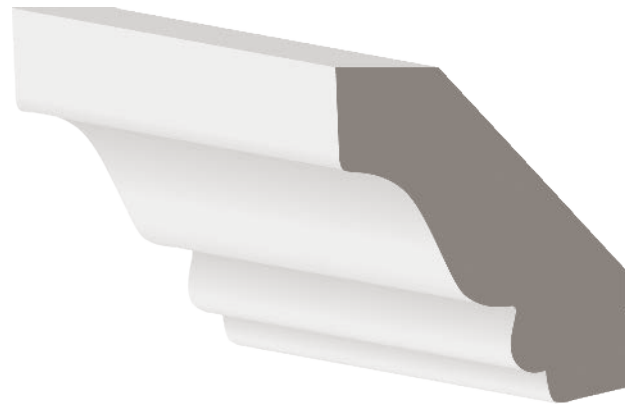

Stock Code Dimensions
104CRPOP $\frac{3}{4}" \times 2\frac{1}{4}" \times RL$
 POP

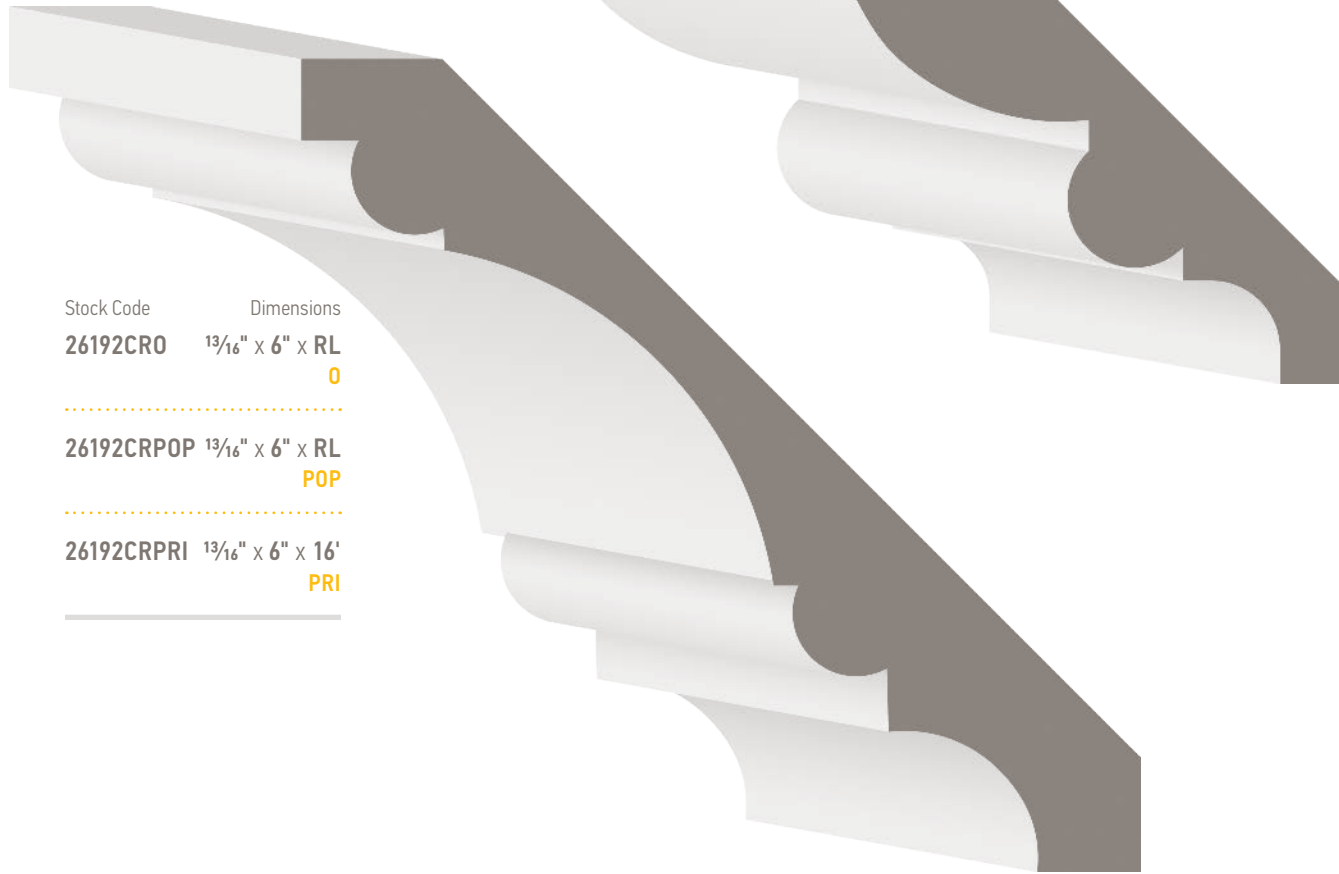

Stock Code Dimensions
26192CRO $1\frac{3}{16}" \times 6" \times RL$
 O

.....
26192CRPOP $1\frac{3}{16}" \times 6" \times RL$
 POP

.....
26192CRPRI $1\frac{3}{16}" \times 6" \times 16'$
 PRI

CROWNS

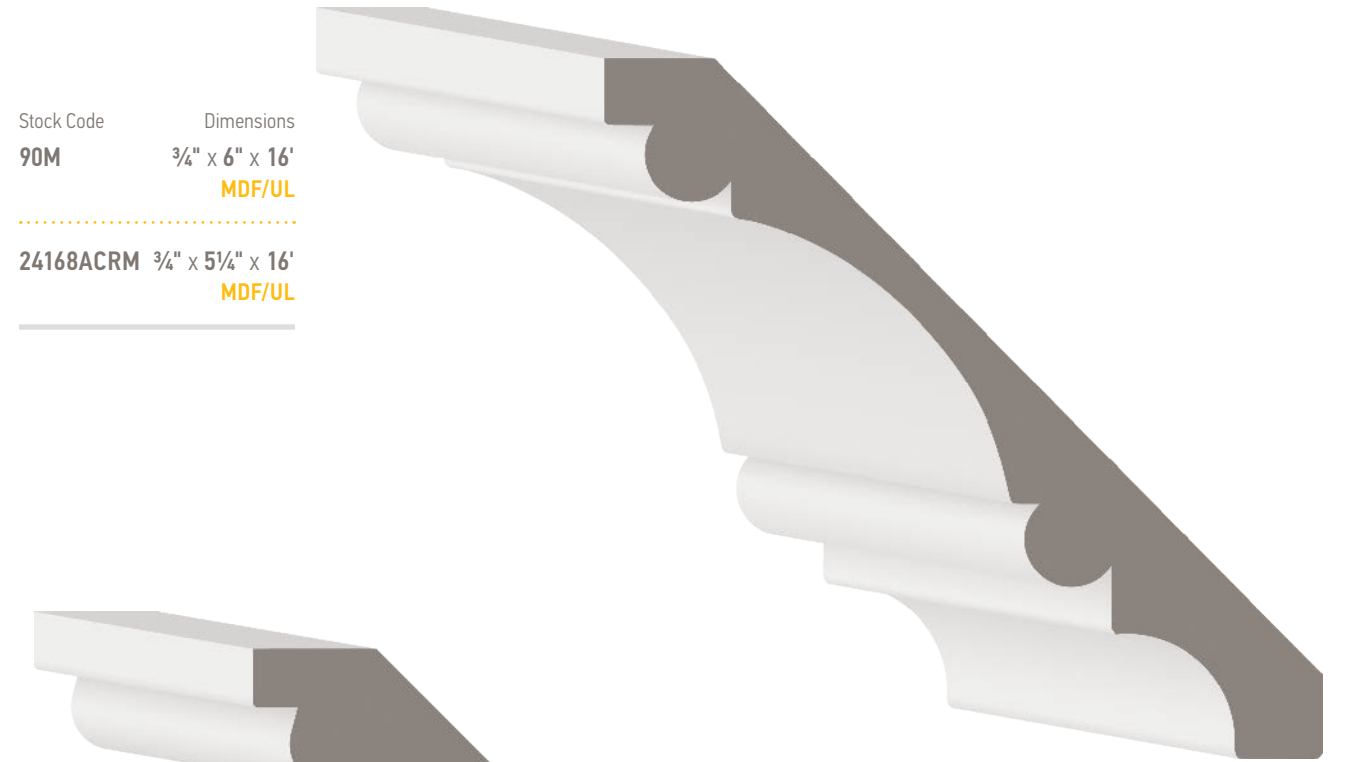

Stock Code Dimensions
90M $\frac{3}{4}" \times 6" \times 16'$
 MDF/UL

.....
24168ACRM $\frac{3}{4}" \times 5\frac{1}{4}" \times 16'$
 MDF/UL

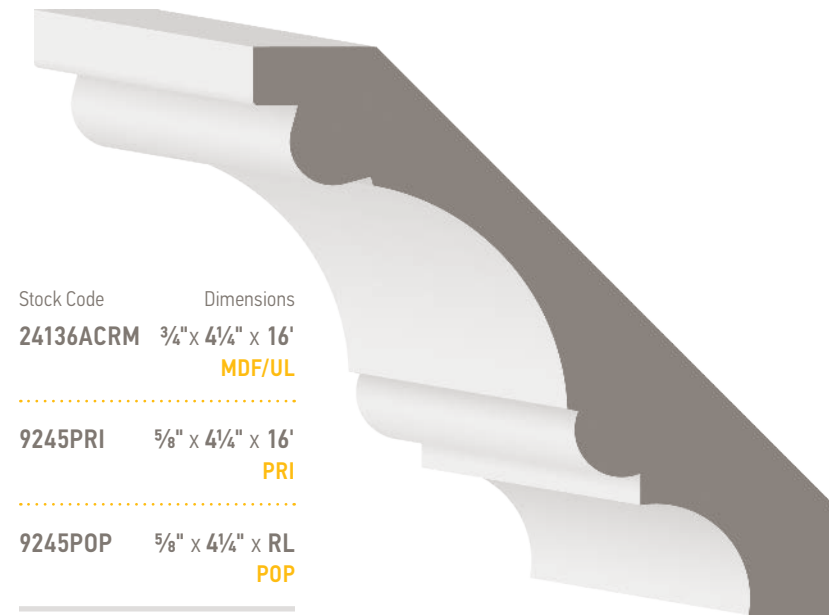

Stock Code Dimensions
24136ACRM $\frac{3}{4}" \times 4\frac{1}{4}" \times 16'$
 MDF/UL

.....
9245PRI $\frac{5}{8}" \times 4\frac{1}{4}" \times 16'$
 PRI

.....
9245POP $\frac{5}{8}" \times 4\frac{1}{4}" \times RL$
 POP

CROWNS

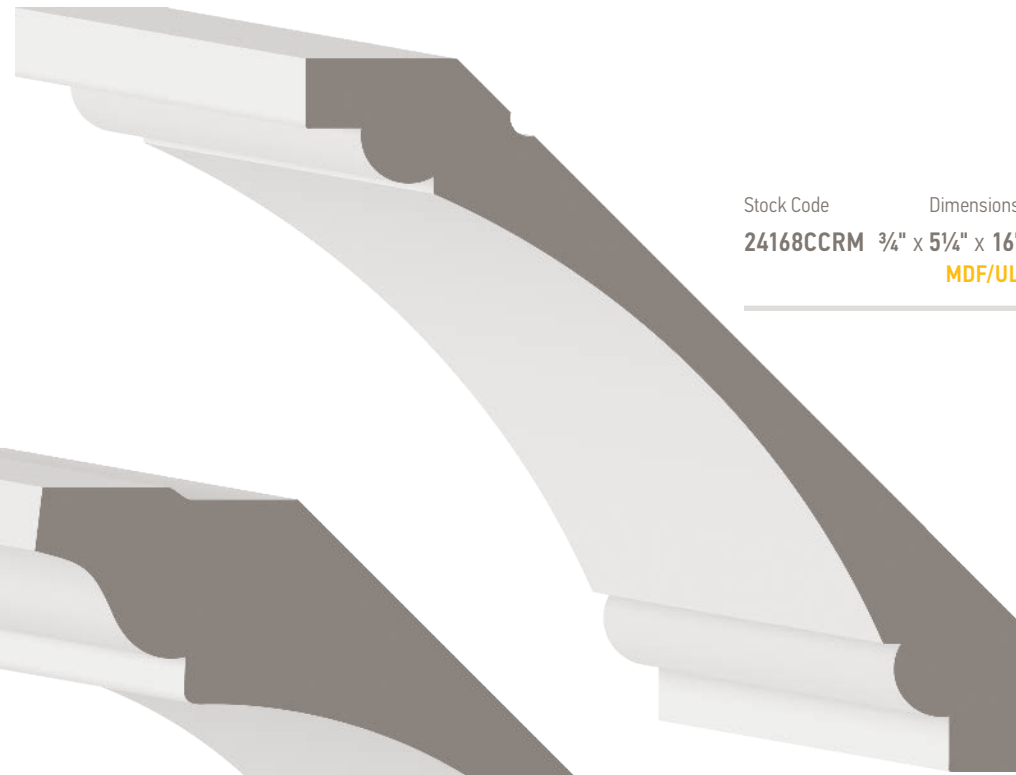

Stock Code Dimensions
24168CCRM $\frac{3}{4}$ " x $5\frac{1}{4}$ " x 16'
MDF/UL



Stock Code Dimensions
41M $1\frac{3}{16}$ " x $6\frac{5}{16}$ " x 16'
MDF/UL

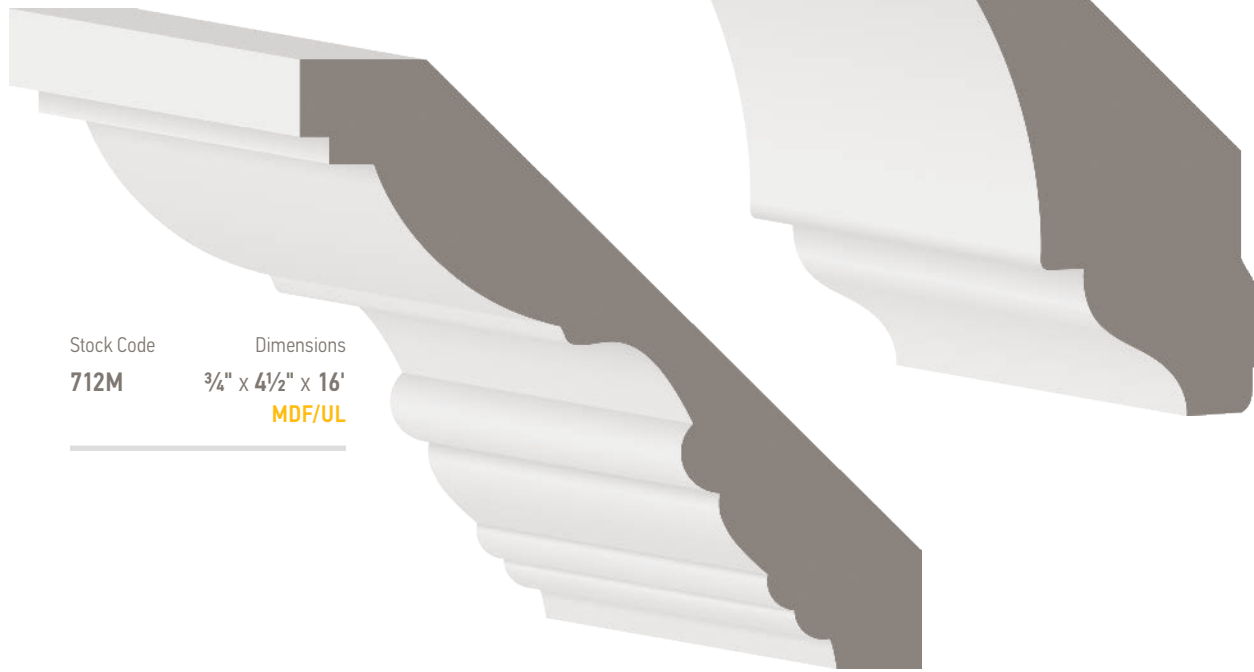

Stock Code Dimensions
712M $\frac{3}{4}$ " x $4\frac{1}{2}$ " x 16'
MDF/UL

CROWNS



Stock Code Dimensions
27M $1\frac{1}{16}$ " x $6\frac{7}{8}$ " x 16'
MDF/UL

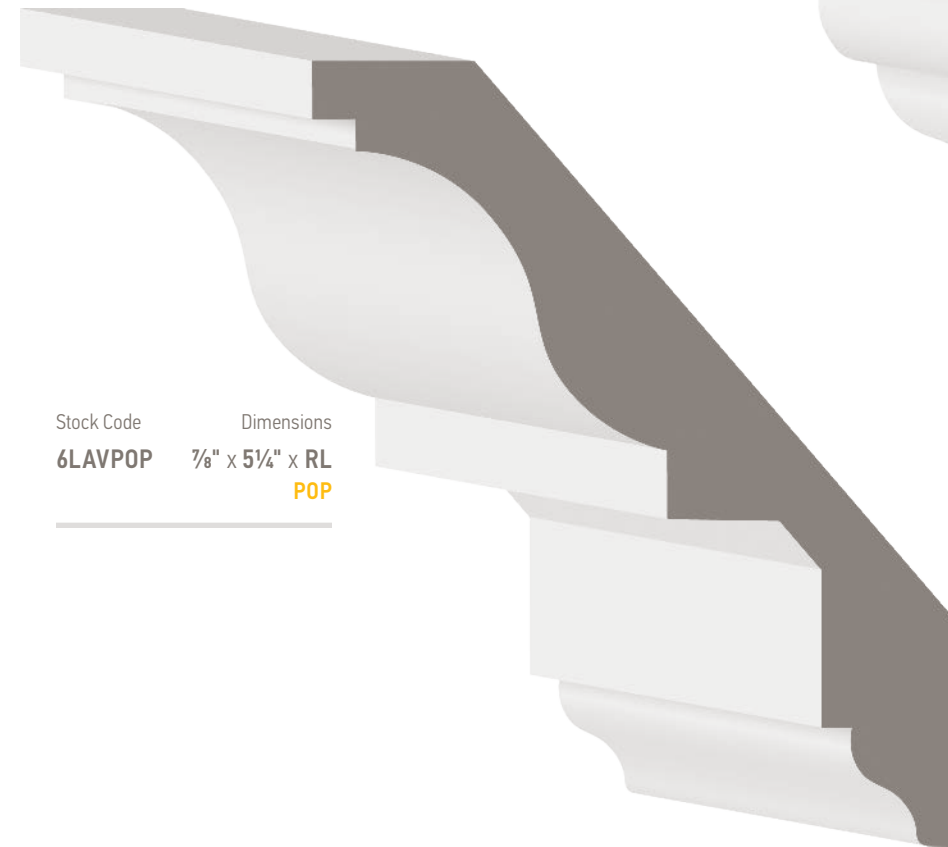

Stock Code Dimensions
6LAVPOP $\frac{7}{8}$ " x $5\frac{1}{4}$ " x RL
POP

CROWNS

Stock Code
830M

Dimensions
1 1/8" x 5 1/2" x 16'
MDF/UL

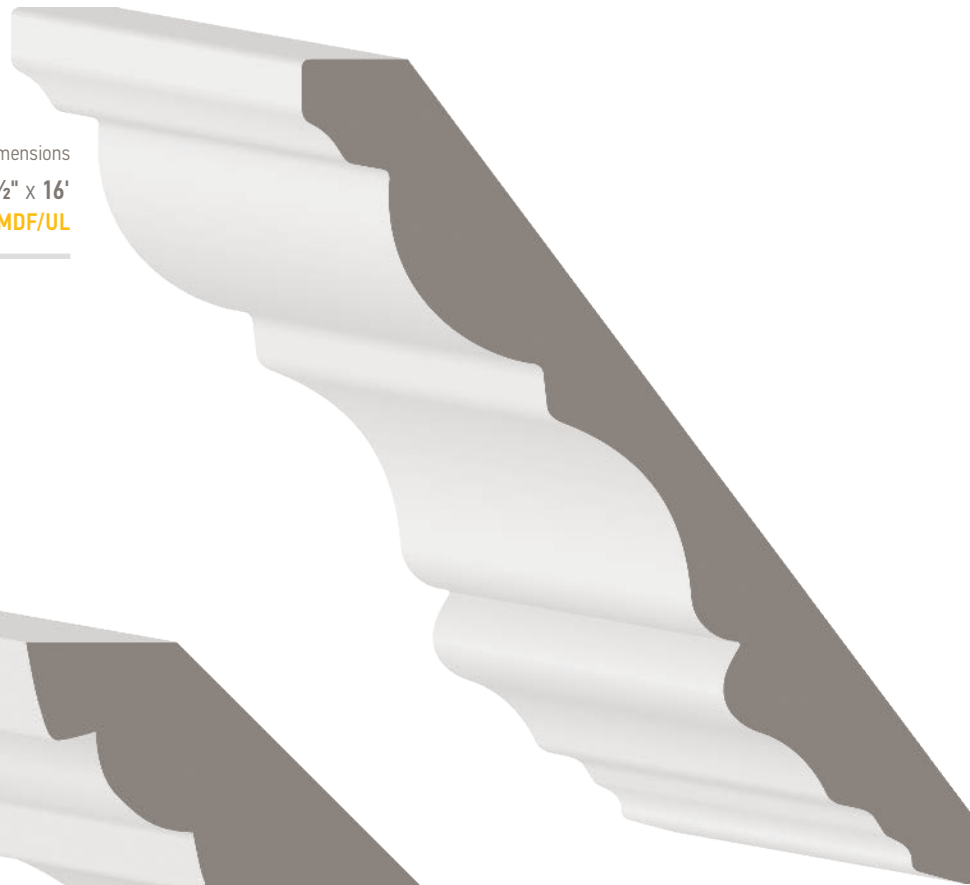

Stock Code
4800PRI

Dimensions
1 3/16" x 7" x 16'
PRI



CROWNS

Stock Code
9253PRI

Dimensions
1 1/8" x 5 5/16" x 16'
FPP



Stock Code
28192CRM

Dimensions
7/8" x 6" x 16'
MDF/UL



DOOR STOPS

DOOR STOPS

The door stop mouldings are attached to the door jamb on both sides and at the top. It is where the door comes to a rest when it is closed, stopping the door from moving any further and covering the gap that would otherwise appear between the door and the jambs.



Stock Code **877LMI90** Dimensions $\frac{1}{2}'' \times 1\frac{1}{4}'' \times 90''$
MDF/UL

Stock Code **877LPRI** Dimensions $\frac{1}{2}'' \times 1\frac{1}{4}'' \times 16'$
PRI



Stock Code **877LPRII98** Dimensions $\frac{1}{2}'' \times 1\frac{1}{4}'' \times 98''$
PRI



Stock Code **876** Dimensions $\frac{7}{16}'' \times 1\frac{3}{8}'' \times \text{RL}$
PIN



Stock Code **887LO** Dimensions $\frac{3}{8}'' \times 1\frac{1}{4}'' \times \text{RL}$
O



Stock Code **887CEF07** Dimensions $\frac{5}{16}'' \times 1\frac{1}{4}'' \times 7'$
PEC

Stock Code **885** Dimensions $\frac{3}{8}'' \times 1\frac{5}{8}'' \times \text{RL}$
PIN

Stock Code **887LOF07** Dimensions $\frac{3}{8}'' \times 1\frac{1}{4}'' \times 7'$
O

Stock Code **887LP** Dimensions $\frac{3}{8}'' \times 1\frac{1}{4}'' \times \text{RL}$
FPP

Stock Code **887** Dimensions $\frac{5}{16}'' \times 1\frac{1}{4}'' \times \text{RL}$
PIN

Stock Code **887LPF07** Dimensions $\frac{3}{8}'' \times 1\frac{1}{4}'' \times 7'$
FPP

Stock Code **887F07** Dimensions $\frac{5}{16}'' \times 1\frac{1}{4}'' \times 7'$
PIN

DOOR STOPS



Stock Code **200WCPO** Dimensions $1\frac{1}{32}'' \times \frac{7}{8}''$
POP



Stock Code **887LMAPI80** Dimensions $\frac{3}{8}'' \times 1\frac{3}{16}'' \times 80''$
MAP



Stock Code **887LPOP** Dimensions $\frac{3}{8}'' \times 1\frac{3}{16}'' \times \text{RL}$
POP

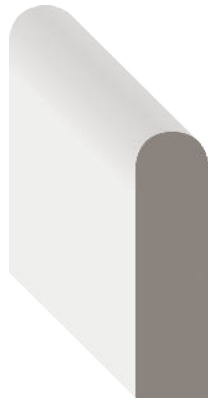

Stock Code **953LPOP** Dimensions $\frac{3}{8}'' \times 1\frac{3}{8}'' \times \text{RL}$
POP

Stock Code **887LPOP07** Dimensions $\frac{3}{8}'' \times 1\frac{3}{16}'' \times 7'$
POP



Stock Code **846** Dimensions $\frac{7}{16}'' \times 1\frac{3}{8}'' \times \text{RL}$
PIN



Stock Code **313PRIF07** Dimensions $\frac{3}{4}'' \times 1\frac{5}{8}'' \times 7'$
PRI



Stock Code **952LPOP** Dimensions $\frac{1}{4}'' \times \frac{7}{8}'' \times \text{RL}$
POP

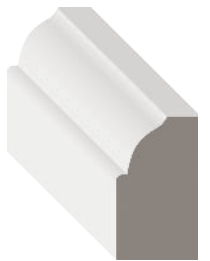

Stock Code **941LPRI** Dimensions $\frac{7}{16}'' \times \frac{3}{4}'' \times 16'$
PRI

Stock Code **846F07** Dimensions $\frac{7}{16}'' \times 1\frac{3}{8}'' \times 7'$
PIN

Stock Code **313BFPOP07** Dimensions $\frac{3}{4}'' \times 1\frac{3}{8}'' \times 7'$
POP

Stock Code **846LPOP07** Dimensions $\frac{7}{16}'' \times 1\frac{3}{8}'' \times 7'$
POP

Stock Code **952LPRI** Dimensions $\frac{1}{4}'' \times \frac{7}{8}'' \times 16'$
PRI

DOOR STOPS



Stock Code Dimensions
947 3/8" x 1 1/4" x RL
PIN

Stock Code Dimensions
9470 3/8" x 1 1/4" x RL
O

Stock Code Dimensions
9470F07 3/8" x 1 1/4" x 7'
O

Stock Code Dimensions
947CEF07 5/16" x 1 3/16" x 7'
PEC

Stock Code Dimensions
947F07 3/8" x 1 1/4" x 7'
PIN

Stock Code Dimensions
947P 3/8" x 1 1/4" x RL
FPP

Stock Code Dimensions
947PF07 3/8" x 1 1/4" x 7'
FPP

Stock Code Dimensions
947POP 3/8" x 1 3/16" x RL
POP

Stock Code Dimensions
947POP198 3/8" x 1 3/16" x 98"
POP

Stock Code Dimensions
947POPF07 3/8" x 1 3/16" x 7'
POP



Stock Code Dimensions
943L 3/8" x 2 1/8" x RL
PIN



Stock Code Dimensions
937MF07 1/2" x 1 1/4" x 7'
MDF/UL



Stock Code Dimensions
936PF07 7/16" x 1 3/8" x 7'
FPP

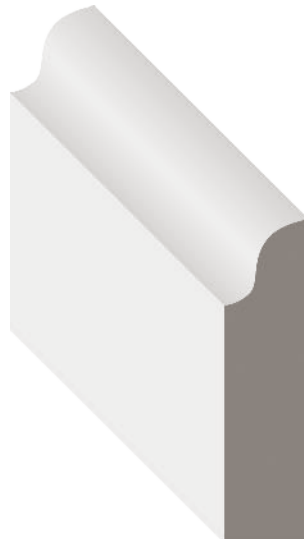

Stock Code Dimensions
905L 7/16" x 1 5/8" x RL
PIN

Stock Code Dimensions
945 3/8" x 1 5/8" x RL
PIN

Stock Code Dimensions
937PRI 7/16" x 1 1/4"
PRI

Stock Code Dimensions
905LP 7/16" x 1 5/8" x RL
FPP

Stock Code Dimensions
9450 3/8" x 1 5/8" x RL
O

Stock Code Dimensions
937PRIF07 7/16" x 1 1/4" x 7'
PRI

Stock Code Dimensions
906 7/16" x 1 3/8" x RL
PIN

Stock Code Dimensions
946 3/8" x 1 3/8" x RL
PIN

Stock Code Dimensions
937PRI102 7/16" x 1 1/4" x 102"
PRI

Stock Code Dimensions
946F07 3/8" x 1 3/8" x 7'
PIN

FLAT STOCK

FLAT STOCK

Finished boards come in either S4S (Surfaced 4 Sides) or S3S (Surfaced 3 Sides) and are used for a multitude of purposes, including shelving, window ledges, base, casing, etc.

Stock Code	Thickness	Height	Length	Species
110E4ECE	21/32"	9-1/4"	14'	PEC
110S4SC	3/4"	9-1/4"	RL	CHR
112S4SC	3/4"	11-1/4"	RL	CHR
12S4SP	23/32"	1-1/2"	16'	FPP
13LS4SPRI	11/16"	2-5/8"	16'	PRI
14S4SC	3/4"	3-1/2"	RL	CHR
16S4SC	3/4"	5-1/2"	RL	CHR
18S4SC	3/4"	7-1/4"	RL	CHR
18S4SPRIF12	3/4"	7-1/4"	12'	PRI
246L	11/16"	2-3/4"	RL	PIN
249MAPF07	3/4"	1-5/8"	7'	MAP
249POPF07	3/4"	1-5/8"	7'	POP
24S4SPOPF08	1-1/2"	3-1/2"	8'	POP
24S4SPOPF10	1-1/2"	3-1/2"	10'	POP
24S4SPOPF12	1-1/2"	3-1/2"	12'	POP
24S4SPOPF16	1-1/2"	3-1/2"	16'	POP
251LP	21/32"	1-3/8"	16'	FPP
254F08	1/2"	3/4"	8'	PIN
254O	1/2"	3/4"	RL	O
259POP	1/4"	6"	RL	POP
26S4SPOPF08	1-1/2"	5-1/2"	8'	POP
26S4SPOPF10	1-1/2"	5-1/2"	10'	POP
26S4SPOPF12	1-1/2"	5-1/2"	12'	POP
26S4SPOPF16	1-1/2"	5-1/2"	16'	POP
28S4SPOPF08	1-1/2"	7-1/4"	8'	POP
28S4SPOPF10	1-1/2"	7-1/4"	10'	POP
28S4SPOPF12	1-1/2"	7-1/4"	12'	POP
5410S4SPOPF08	1-1/16"	9-1/4"	8'	POP
5410S4SPOPF10	1-1/16"	9-1/4"	10'	POP
5410S4SPOPF12	1-1/16"	9-1/4"	12'	POP
5410S4SPOPF16	1-1/16"	9-1/4"	16'	POP
5412S4SPOPF08	1-1/16"	11-1/4"	8'	POP
5412S4SPOPF10	1-1/16"	11-1/4"	10'	POP
5412S4SPOPF12	1-1/16"	11-1/4"	12'	POP
542FS4SPOP	1-1/16"	2"	RL	POP
544S4SPOPF08	1-1/16"	3-1/2"	8'	POP
544S4SPOPF10	1-1/16"	3-1/2"	10'	POP
544S4SPOPF12	1-1/16"	3-1/2"	12'	POP
544S4SPOPF16	1-1/16"	3-1/2"	16'	POP
546S4S	1-3/16"	5-1/2"	RL	PIN
546S4SO	1-1/16"	5-1/2"	RL	O
546S4SPOP	1-1/16"	5-1/2"	RL	POP
546S4SPOPF08	1-1/16"	5-1/2"	8'	POP
546S4SPOPF10	1-1/16"	5-1/2"	10'	POP
546S4SPOPF12	1-1/16"	5-1/2"	12'	POP
546S4SPOPF16	1-1/16"	5-1/2"	16'	POP

FLAT STOCK

Stock Code	Thickness	Height	Length	Species
546S4SXP	1-1/16"	5-1/2"	16'	FPP
548S4S	1-3/16"	7-1/4"	RL	PIN
548S4SO	1-1/16"	7-1/4"	RL	O
548S4SPOP	1-1/16"	7-1/4"	RL	POP
548S4SPOPF08	1-1/16"	7-1/4"	8'	POP
548S4SPOPF10	1-1/16"	7-1/4"	10'	POP
548S4SPOPF12	1-1/16"	7-1/4"	12'	POP
548S4SPOPF16	1-1/16"	7-1/4"	16'	POP
548S4SXP	1-1/16"	7-1/4"	16'	FPP
110S4S	3/4"	9-1/4"	RL	PIN
110S4SF08	3/4"	9-1/4"	8'	PIN
110S4SF10	3/4"	9-1/4"	10'	PIN
110S4SF12	3/4"	9-1/4"	12'	PIN
110S4SF16	3/4"	9-1/4"	16'	PIN
110S4SM	11/16"	9-1/4"	16'	MDF/UL
110S4SMAP	3/4"	9-1/4"	RL	MAP
110S4SO	3/4"	9-1/4"	RL	O
110S4SOF08	3/4"	9-1/4"	8'	O
110S4SOF10	3/4"	9-1/4"	10'	O
110S4SOF12	3/4"	9-1/4"	12'	O
110S4SOF14	3/4"	9-1/4"	14'	O
110S4SOF16	3/4"	9-1/4"	16'	O
110S4SP	23/32"	9-1/4"	16'	FPP
110S4SPOP	3/4"	9-1/4"	RL	POP
110S4SPOPF08	3/4"	9-1/4"	8'	POP
110S4SPOPF10	3/4"	9-1/4"	10'	POP
110S4SPOPF12	3/4"	9-1/4"	12'	POP
110S4SPOPF14	3/4"	9-1/4"	14'	POP
110S4SPOPF16	3/4"	9-1/4"	16'	POP
110S4SPRI	3/4"	9-1/4"	16'	PRI
110S4SXP	23/32"	9-1/4"	16'	FPP
112S4S	3/4"	11-1/4"	RL	PIN
112S4SF08	3/4"	11-1/4"	8'	PIN
112S4SF10	3/4"	11-1/4"	10'	PIN
112S4SF12	3/4"	11-1/4"	12'	PIN
112S4SF14	3/4"	11-1/4"	14'	PIN
112S4SF16	3/4"	11-1/4"	16'	PIN
112S4SFJ	23/32"	11-1/4"	16'	FJP
112S4SFJPF16	3/4"	11-1/4"	16'	POP
112S4SM	11/16"	11-1/4"	16'	MDF/UL
112S4SMAP	3/4"	11-1/4"	RL	MAP
112S4SMVF16	3/4"	11-1/4"	16'	MAP
112S4SO	3/4"	11-1/4"	RL	O
112S4SOF08	3/4"	11-1/4"	8'	O
112S4SOF10	3/4"	11-1/4"	10'	O
112S4SOF12	3/4"	11-1/4"	12'	O

Stock Code	Thickness	Height	Length	Species
112S4SOF16	3/4"	11-1/4"	16'	O
112S4SOVF16	3/4"	11-1/4"	16'	O
112S4SP	23/32"	11-1/4"	16'	FPP
112S4SPOP	3/4"	11-1/4"	RL	POP
112S4SPOPF08	3/4"	11-1/4"	8'	POP
112S4SPOPF10	3/4"	11-1/4"	10'	POP
112S4SPOPF12	3/4"	11-1/4"	12'	POP
112S4SPOPF14	3/4"	11-1/4"	14'	POP
112S4SPOPF16	3/4"	11-1/4"	16'	POP
112S4SPRI	3/4"	11-1/4"	16'	PRI
112S4SPRIF18	3/4"	11-1/4"	18'	FPP
112S4SXP	23/32"	11-1/4"	16'	FPP
126S4SPOP	1/2"	5-1/2"	RL	POP
128S4SPOP	1/2"	7-1/4"	RL	POP
12LS4SPRIF07	3/4"	1-5/8"	7'	PRI
12S4SMAP	3/4"	1-3/4"	RL	MAP
12S4SO	3/4"	1-3/4"	RL	O
12S4SPOP	3/4"	1-3/4"	RL	POP
12S4SXP	23/32"	1-1/2"	16'	FPP
13S4SPOP	3/4"	2-1/2"	RL	POP
14S4S	3/4"	3-1/2"	RL	PIN
14S4SF08	3/4"	3-1/2"	8'	PIN
14S4SF10	3/4"	3-1/2"	10'	PIN
14S4SF12	3/4"	3-1/2"	12'	PIN
14S4SF14	3/4"	3-1/2"	14'	PIN
14S4SF16	3/4"	3-1/2"	16'	PIN
14S4SFJ	23/32"	3-1/2"	16'	FJP
14S4SM	11/16"	3-1/2"	16'	MDF/UL
14S4SMAP	3/4"	3-1/2"	RL	MAP
14S4SO	3/4"	3-1/2"	RL	O
14S4SOF08	3/4"	3-1/2"	8'	O
14S4SOF10	3/4"	3-1/2"	10'	O
14S4SOF12	3/4"	3-1/2"	12'	O
14S4SOF16	3/4"	3-1/2"	16'	O
14S4SP	23/32"	3-1/2"	16'	FPP
14S4SPOP	3/4"	3-1/2"	RL	POP
14S4SPOPF08	3/4"	3-1/2"	8'	POP
14S4SPOPF10	3/4"	3-1/2"	10'	POP
14S4SPOPF12	3/4"	3-1/2"	12'	POP
14S4SPOPF14	3/4"	3-1/2"	14'	POP
14S4SPOPF16	3/4"	3-1/2"	16'	POP
14S4SPRI	3/4"	3-1/2"	16'	PRI
14S4SXP	23/32"	3-1/2"	16'	FPP
16E2EM	11/16"	5-1/2"	16'	MDF/UL
16E4ECE	21/32"	5-1/2"	14'	PEC
16S4S	3/4"	5-1/2"	RL	PIN

Stock Code	Thickness	Height	Length	Species
16S4SF08	3/4"	5-1/2"	8'	PIN
16S4SF10	3/4"	5-1/2"	10'	PIN
16S4SF12	3/4"	5-1/2"	12'	PIN
16S4SF14	3/4"	5-1/2"	14'	PIN
16S4SF16	3/4"	5-1/2"	16'	PIN
16S4SFJ	23/32"	5-1/2"	16'	FJP
16S4SM	11/16"	5-1/2"	16'	MDF/UL
16S4SMAP	3/4"	5-1/2"	RL	MAP
16S4SO	3/4"	5-1/2"	RL	O
16S4SOF08	3/4"	5-1/2"	8'	O
16S4SOF10	3/4"	5-1/2"	10'	O
16S4SOF12	3/4"	5-1/2"	12'	O
16S4SOF16	3/4"	5-1/2"	16'	O
16S4SP	23/32"	5-1/2"	16'	FPP
16S4SPOP	3/4"	5-1/2"	RL	POP
16S4SPOPF08	3/4"	5-1/2"	8'	POP
16S4SPOPF10	3/4"	5-1/2"	10'	POP
16S4SPOPF12	3/4"	5-1/2"	12'	POP
16S4SPOPF14	3/4"	5-1/2"	14'	POP
16S4SPOPF16	3/4"	5-1/2"	16'	POP
16S4SPRI	3/4"	5-1/2"	16'	PRI
16S4SXP	23/32"	5-1/2"	16'	FPP
22S4SPOPF12	1-1/2"	1-1/2"	12'	POP
22S4SPOPF16	1-1/2"	1-1/2"	16'	POP
248L	21/32"	1-3/4"	RL	PIN
248LP	21/32"	1-3/4"	16'	FPP
5410S4S	1-3/16"	9-1/4"	RL	PIN
5410S4SO	1-1/16"	9-1/4"	RL	O
5410S4SPOP	1-1/16"	9-1/4"	RL	POP
5412S4S	1-3/16"	11-1/4"	RL	PIN
5412S4SO	1-1/16"	11-1/4"	RL	O
5412S4SPOP	1-1/16"	11-1/4"	RL	POP
5412S4SXP	1-1/16"	11-1/4"	16'	FPP
544S4S	1-3/16"	3-1/2"	RL	PIN
544S4SO	1-1/16"	3-1/2"	RL	O
544S4SXP	1-1/16"	3-1/2"	16'	FPP

Eased 2 Edges

14E2EMDF	11/16"	3-1/2"	16'	MDF/UL
16E2EMDF	11/16"	5-1/2"	16'	MDF/UL
17E2EMAP	3/4"	6-1/2"	RL	MAP
17E2EPOP	3/4"	6-1/2"	RL	POP
17E2EPRI	3/4"	6-1/2"	RL	PRI
18E2EM	11/16"	7-1/4"	16'	MDF/UL
18S4SM	11/16"	7-1/4"	16'	MDF/UL

FLAT STOCK

Eased 4 Edges				
18E4ECE	21/32"	7-1/4"	14'	PEC

Square Edges				
1212S4SPOP	1/2"	11-1/4"	RL	POP
18S4S	3/4"	7-1/4"	RL	PIN
18S4SF08	3/4"	7-1/4"	8'	PIN
18S4SF10	3/4"	7-1/4"	10'	PIN
18S4SF12	3/4"	7-1/4"	12'	PIN
18S4SF14	3/4"	7-1/4"	14'	PIN
18S4SF16	3/4"	7-1/4"	16'	PIN
18S4SFJ	23/32"	7-1/4"	16'	FJP
18S4SMAP	3/4"	7-1/4"	RL	MAP
18S4SO	3/4"	7-1/4"	RL	O
18S4SOF08	3/4"	7-1/4"	8'	O
18S4SOF10	3/4"	7-1/4"	10'	O
18S4SOF12	3/4"	7-1/4"	12'	O
18S4SOF14	3/4"	7-1/4"	14'	O
18S4SOF16	3/4"	7-1/4"	16'	O
18S4SP	23/32"	7-1/4"	16'	FPP
18S4SPOP	3/4"	7-1/4"	RL	POP
18S4SPOPF08	3/4"	7-1/4"	8'	POP
18S4SPOPF10	3/4"	7-1/4"	10'	POP
18S4SPOPF12	3/4"	7-1/4"	12'	POP
18S4SPOPF14	3/4"	7-1/4"	14'	POP
18S4SPOPF16	3/4"	7-1/4"	16'	POP
18S4SPRI	3/4"	7-1/4"	16'	PRI
18S4SXP	23/32"	7-1/4"	16'	FPP

Moulding				
254	1/2"	3/4"	RL	PIN

HAND RAILS

Hand rails provide safety and support.



Stock Code Dimensions
231FJHF16 1 7/16" x 1 5/8" x 16'
H

Stock Code Dimensions
231 1 7/16" x 1 5/8" x RL
PIN

231FJHF12 1 7/16" x 1 5/8" x 12'
H

231FJHF18 1 7/16" x 1 5/8" x 18'
H

231HF16 1 7/16" x 1 5/8" x 16'
H

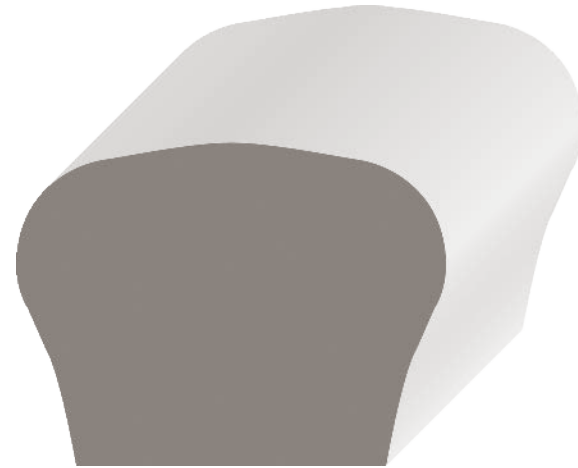

Stock Code Dimensions
55FJPF16 1 3/4" x 2 1/4" x 16'
FJP

55FJPF18 1 3/4" x 2 1/4" x 18'
FJP

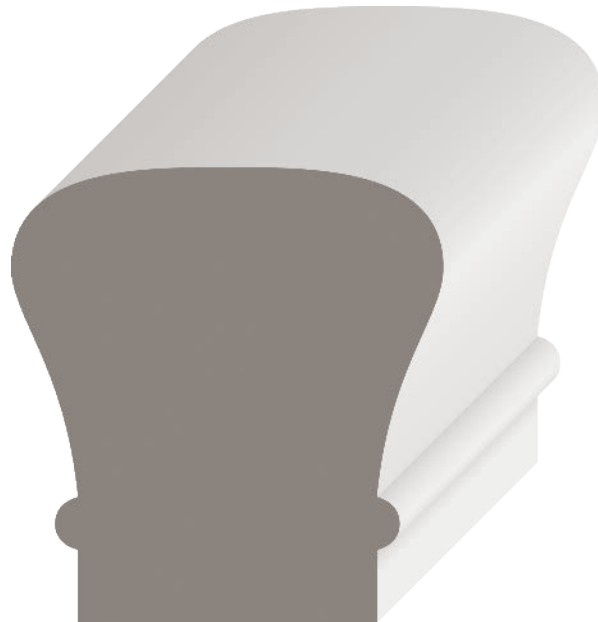

Stock Code Dimensions
6010HF16 2 3/8" x 2 1/4" x 16'
H

Stock Code Dimensions
240 1 1/4" x 2 1/4" x RL
PIN

240FJO 1 1/4" x 2 1/4" x 16'
O

JAMBS

The top and two sides of a door or window frame that contact the door or sash: top jamb and side jambs. The most common size for interior use is 1 1/16" thick by 4 9/16" wide.

Stock Code	Thickness	Height	Length	Species
FJS4110WV	13/16"	4-11/16"	81-11/16"	OV
FJS458RP	11/16"	4-5/8"	81-11/16"	FPP
FJS47881CE	11/16"	4-13/16"	81-11/16"	PEC
FJS47881J	11/16"	4-7/8"	81-11/16"	FPP
FJS47881M	11/16"	4-7/8"	81-11/16"	MDF/UL
FJS478810WV	11/16"	4-7/8"	81-11/16"	OV
FJS47881P	11/16"	4-7/8"	81-11/16"	FPP
FJS47881PRI	11/16"	4-7/8"	81-11/16"	PRI
FJS47881WV	11/16"	4-13/16"	81-11/16"	PINV
FJS47885P	11/16"	4-7/8"	85-11/16"	FPP
FJS47897P	11/16"	4-7/8"	97-11/16"	FPP
FJS47897POP	11/16"	4-7/8"	97-11/16"	POP
FJS47897PRI	11/16"	4-7/8"	97-11/16"	PRI
FJS481CE	11/16"	4-9/16"	81-11/16"	PEC
FJS481J	11/16"	4-9/16"	81-11/16"	FPP
FJS481M	11/16"	4-5/8"	81-11/16"	MDF/UL
FJS4810VWC	11/16"	4-9/16"	81-11/16"	OV
FJS4810WV	11/16"	4-9/16"	81-11/16"	OV
FJS481P	11/16"	4-5/8"	81-11/16"	FPP
FJS481PJ	11/16"	4-9/16"	81-11/16"	FPP
FJS481POP	11/16"	4-9/16"	81-11/16"	POP
FJS481PRI	11/16"	4-9/16"	81-11/16"	PRI
FJS481WV	11/16"	4-9/16"	81-11/16"	PINV
FJS481WVWC	11/16"	4-9/16"	81-11/16"	PINV
FJS497P	11/16"	4-9/16"	97-11/16"	FPP
FJS497POP	11/16"	4-9/16"	97-11/16"	POP
FJS497PRI	11/16"	4-9/16"	97-11/16"	PRI
FJS4RCE	11/16"	4-9/16"	14'	PEC
FJS4RP	11/16"	4-9/16"	16'	FPP
FJS4RPRI	11/16"	4-5/8"	16'	PRI
FJS5081P	11/16"	5"	81-11/16"	FPP
FJS5097P	11/16"	5"	97-11/16"	FPP
FJS581P	11/16"	5-1/4"	81-11/16"	FPP
FJS67881P	11/16"	6-7/8"	81-11/16"	FPP
FJS67897P	11/16"	6-7/8"	97-11/16"	FPP
FJS681CE	11/16"	6-9/16"	81-11/16"	PEC
FJS681P	11/16"	6-5/8"	81-11/16"	FPP
FJS681PRI	11/16"	6-9/16"	81-11/16"	PRI
FJS697P	11/16"	6-5/8"	97-11/16"	FPP
FJS697POP	11/16"	6-9/16"	8'	POP
FJS697PRI	11/16"	6-9/16"	97-11/16"	PRI
SJS481	1-5/8"	4-5/8"	81-13/16"	PIN
SJS481FJ	1-5/8"	4-5/8"	81-11/16"	FJP
SJS481J	1-5/8"	4-5/8"	81-13/16"	FPP
SJS481P	1-5/8"	4-5/8"	81-13/16"	FPP
SJS481WFJ	1-1/16"	4-5/8"	81-11/16"	FJP
SJS481WJ	1-5/8"	4-5/8"	81-11/16"	FPP
SJS481WP	1-1/16"	4-5/8"	81-11/16"	FPP

PANEL MOULDS

PANEL MOULDS

The use of panel or picture moulding can be an effective and inexpensive way to frame wall paneling, paper or fabric, and add interest to walls.



Stock Code Dimensions
7PMPOP 1" x 2 1/16" x RL
POP



Stock Code Dimensions
9514PRI 1 1/16" x 1 5/8" x 16'
PRI



Stock Code Dimensions
184P 1/2" x 1 1/2" x 16'
FPP



Stock Code Dimensions
3264PRPOP 1" x 2" x RL
POP

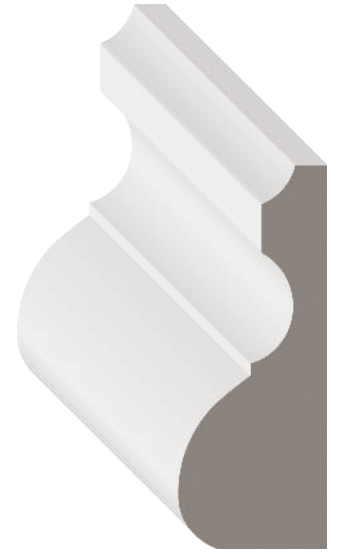

Stock Code Dimensions
2664PPOP 1 3/16" x 2" x RL
POP

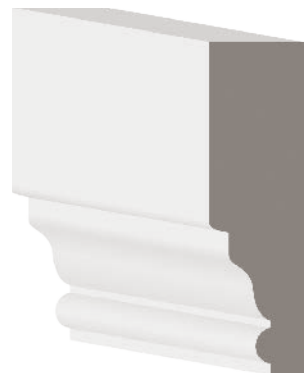

Stock Code Dimensions
2480CBPOP 3/4" x 2 1/2" x RL
POP



Stock Code Dimensions
17P 1 1/16" x 2 1/4" x 16'
FPP



Stock Code Dimensions
182P 1 1/16" x 1 5/8" x 16'
FPP

182 1 1/16" x 1 5/8" x RL
PIN



Stock Code Dimensions
6PM 1 1/16" x 2" x RL
PIN

6PMPOP 1" x 2 1/16" x RL
POP



Stock Code Dimensions
2664PRPOP 1 3/16" x 2" x RL
POP

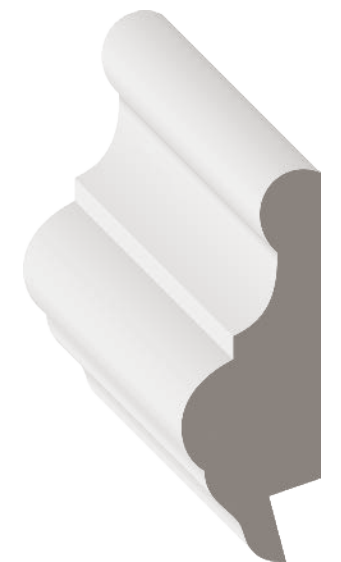

Stock Code Dimensions
2464PMO 3/4" x 2" x RL
O

2464PMO 3/4" x 2" x RL
O

PANEL MOULDS

PANEL MOULDS

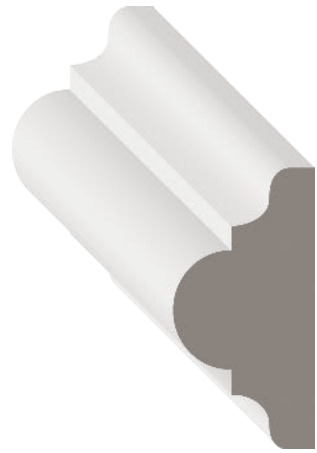

Stock Code Dimensions
2448BMFJP 3/4" x 1 1/2" x 16'
PP

2448BMPPOP 3/4" x 1 1/2" x RL
POP

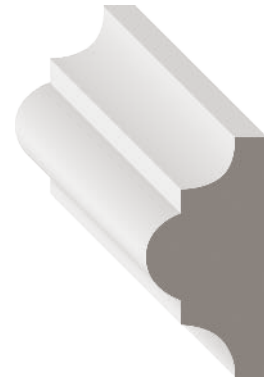

Stock Code Dimensions
134LPOP 5/8" x 1 1/4" x RL
POP



Stock Code Dimensions
185 7/16" x 1 1/2" x RL
PIN



Stock Code Dimensions
133 1 1/16" x 1 3/4" x RL
PIN

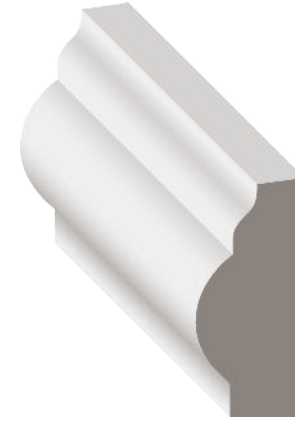

Stock Code Dimensions
427 9/16" x 1 1/8" x RL
PIN



Stock Code Dimensions
140POP 7/16" x 1 1/4" x RL
POP



Stock Code Dimensions
989 3/8" x 1 1/8" x RL
PIN

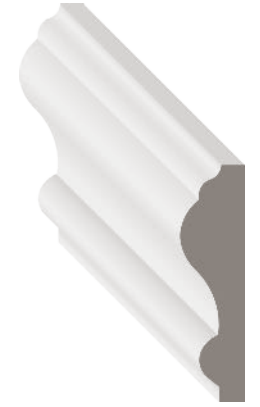

Stock Code Dimensions
185YPOP 5/16" x 1 1/4" x RL
POP

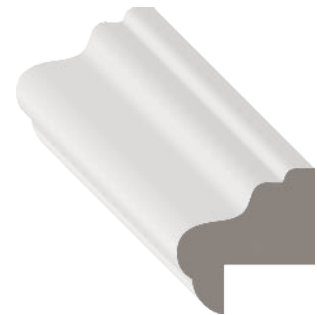

Stock Code Dimensions
2424RPOP 3/4" x 3/4" x RL
POP



Stock Code Dimensions
185KO 7/16" x 1 3/8" x RL
O



Stock Code Dimensions
9516PRI 9/16" x 1 1/2" x 16'
PRI



Stock Code Dimensions
9512PRI 5/8" x 1 1/2" x 16'
PRI



Stock Code Dimensions
200PMPPOP 3/4" x 1 1/16" x RL
POP



Stock Code Dimensions
309PTPOP 5/8" x 1 1/2" x RL
POP

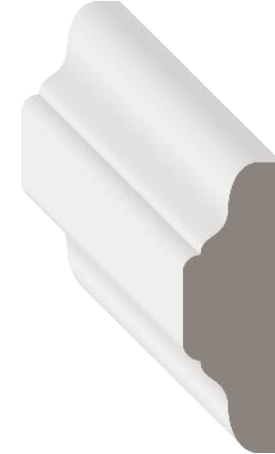

Stock Code Dimensions
1648POP 1/2" x 1 1/2" x RL
POP

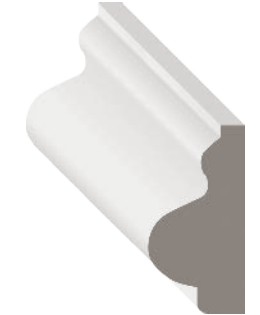

Stock Code Dimensions
462 1/2" x 1" x RL
PIN

PANEL MOULDS

PLINTH BLOCKS

PLINTH BLOCKS

Decorative block installed at the bottom of a casing.



Stock Code Dimensions

PB7420 1 1/16" x 3 1/2" x 6 1/2"
0

PB742POP 1 1/16" x 3 1/2" x 6 1/2"
POP

PB7430 1 1/16" x 4 1/2" x 8"
0

PB743POP 1 1/16" x 4 1/2" x 8"
POP

Stock Code Dimensions

PB795POP 1 1/16" x 5 1/2" x 9 1/4"
POP

PB8160 1 1/16" x 3 3/4" x 6 1/2"
0

PB816POP 1 1/16" x 3 3/4" x 6 1/2"
POP

Stock Code Dimensions

BB170 1 1/16" x 7" x RL
0

BB17POP 1 1/16" x 7" x RL
POP

BB110POP 1 1/16" x 10"
POP

Stock Code Dimensions

BB010POP 1 1/16" x 10" x RL
POP

BB07POP 1 1/16" x 1 1/16" x 7"
POP



SCREEN MOULDS

A very versatile profile; screen mould fits a wide variety of needs and uses. Traditionally used to hold mesh screening into wood screens, it also works well as edge trim on various shelving or wood trim for wallpaper.



Stock Code Dimensions

142 1/4" x 3/4" x RL
PIN

1420 5/16" x 3/4" x RL
0

142POP 1/4" x 3/4" x RL
POP



Stock Code Dimensions

142LPOP 1/4" x 3/4" x RL
POP

348POPF08 5/16" x 3/4" x 8'
POP

1148POPF08 1/16" x 1 1/4" x 8'
POP

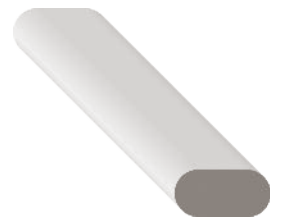

Stock Code Dimensions

1SPO 1/4" x 1/2" x RL
0

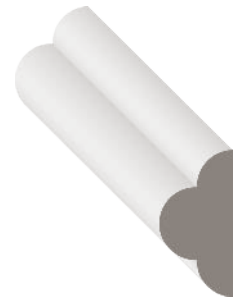

Stock Code Dimensions

137POP 3/8" x 3/4" x RL
POP



Stock Code Dimensions

144 1/4" x 3/4" x RL
PIN

STOOLS

STOOLS

A trim or casing applied immediately below the window sill.



Stock Code: **1153** Dimensions: **1 1/8" x 3 3/8" x RL**
Material: **PIN**



Stock Code: **1164** Dimensions: **1 1/8" x 3" x RL**
Material: **PIN**

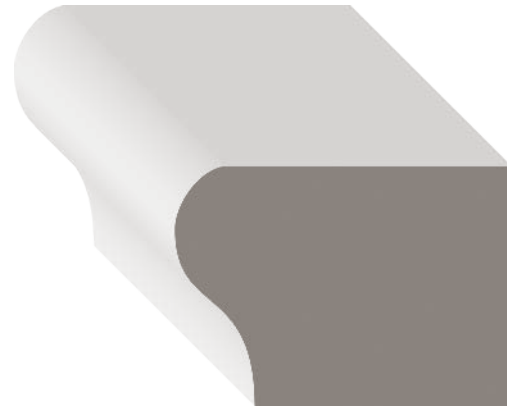

Stock Code: **7POPWC** Dimensions: **1 1/4" x 1 5/8" x RL**
Material: **POP**



Stock Code: **1021J** Dimensions: **1 1/8" x 5 1/4" x 16'**
Material: **FPP**

Stock Code: **1021M** Dimensions: **3/16" x 5 1/4" x 16'**
Material: **MDF/UL**

TONGUE & GROOVE PANELING

TONGUE & GROOVE PANELING

Panels used to decorate or cover a wall, fitted together edge to edge using a slot and ridge on the opposite edge.

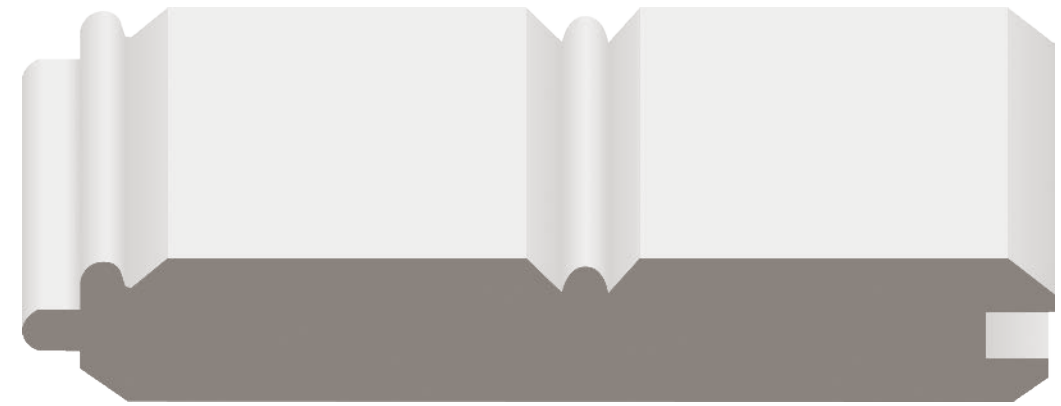

Stock Code: **3454TVGP** Dimensions: **3/4" x 5 3/8" x 16'**
Material: **FPP**



Stock Code: **584TVGH** Dimensions: **3/16" x 3 1/4" x RL**
Material: **H**

TONGUE & GROOVE PANELING

Stock Code Dimensions
3834TVGPOP 3/8" x 3" x RL
POP

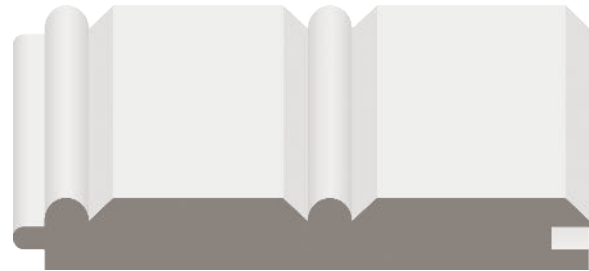

Stock Code Dimensions
584TVGP 9/16" x 3 5/16" x 16'
FPP



Stock Code Dimensions
5834M 5/8" x 3" x 16'
MDF/UL



MISCELLANEOUS

ASTRAGALS

An astragal is commonly used to seal between a pair of doors. The astragal closes the clearance gap. The vertical moulding attaches to a stile on one of a pair of doors against which the other door strikes or closes.

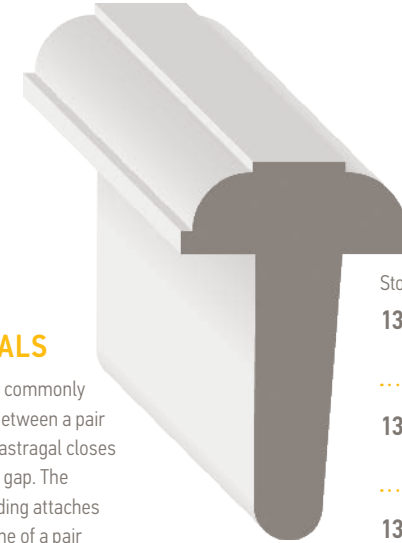

Stock Code Dimensions
1304F07 1 1/4" x 2 1/4" x 7'
PIN

1304POPF08 1 1/4" x 2 1/4" x 8'
POP

1305F07 1 3/16" x 2" x 7'
PIN

Stock Code Dimensions
1305F08 1 3/16" x 2" x 8'
PIN

1305OF08 1 1/8" x 2" x 8'
O

1305POPF08 1 1/8" x 2" x 8'
POP

BAR RAILS

A curved moulding that conceals the edge of a bar top and provides a decorative look.



Stock Code Dimensions
40960 1 1/2" x 3" x RL
O

561440 1 3/4" x 4 1/2" x RL
O

MISCELLANEOUS



BRICK MOULDS

A brick mould is mainly used as exterior casing around doors. The most common size is 2"; however, 1 1/2" and 1 1/4" sizes are available. Brick moulds can also be used in place of a crown and as a transition under window sills.

Stock Code	Dimensions
180	1 1/4" x 2" x RL PIN
180FJF17	1 1/4" x 2" x 17' FJP
180LP	1 1/4" x 2 1/4" FPP
180P	1 1/4" x 2" x RL FPP
180PF08	1 1/4" x 2" x 8' FPP
180PF10	1 1/4" x 2" x 10' FPP
PVC180-18	1 1/4" x 2" x 18' PVC

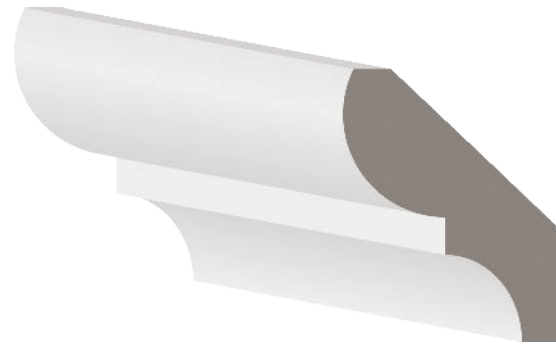

BED MOULD

Similar to crown moulding, used to cover the joint between the ceiling and wall. Can be either sprung or plain, or flush to the wall as an extension of a cornice mould.

Stock Code	Dimensions
74	3/16" x 1 3/4" x RL PIN



CHAMFER STRIP

Utilized where kitchen cabinet tops meet the walls or as a linoleum cove. Sometimes used for window applications.

Stock Code	Dimensions
995	3/4" x 3/4" x RL PIN



DRIP CAP

Applied over exterior window and door frames to keep water or moisture from seeping under the siding. Drip caps also direct water away from window glass. Drip caps may also be called sills.

Stock Code	Dimensions
187	1 1/16" x 2" x RL PIN



DENTIL

A moulding pattern with a series of closely spaced rectangular blocks and spaces. Used especially in classic architecture.

Stock Code	Dimensions
2502POP	1 1/16" x 7/8" x RL POP

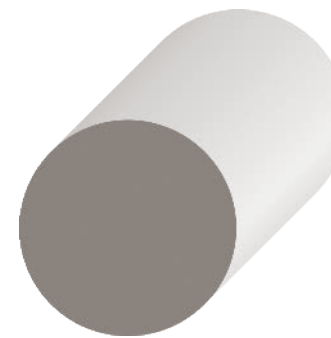

FULL ROUNDS

Full rounds are used for numerous purposes and projects. Some of the more common uses are closet poles, curtain rods and towel rods.

Stock Code	Dimensions
233	1 5/16" x 1 5/16" x RL PIN
233H	1 5/16" x 1 5/16" x RL H

MISCELLANEOUS

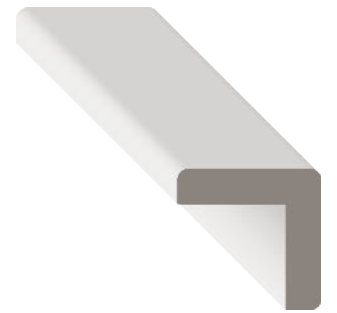

CORNER GUARDS

Corner guards are used to protect the outside edges of the wall from damage and abrasion. Corner guards come in a wide variety of sizes and detailing.

Stock Code	Dimensions
204	1 1/4" x 1 1/4" x RL PIN
204F08	1 1/4" x 1 1/4" x 8' PIN
205	1 1/16" x 1 1/16" x RL PIN
205F08	1 1/16" x 1 1/16" x 8' PIN

Stock Code	Dimensions
2050	1 1/16" x 1 1/16" x RL O
205POP	1 1/16" x 1 1/16" x RL POP
206	3/4" x 3/4" x RL PIN
206F08	3/4" x 3/4" x 8' PIN
2060	3/4" x 3/4" x RL O

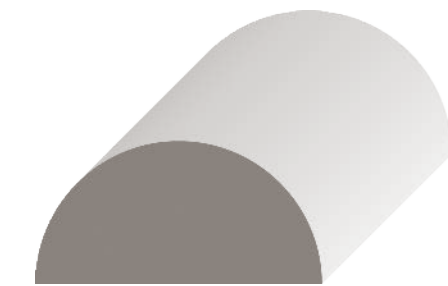

HALF ROUNDS

A cross section of a half round looks like a half circle and is used primarily as decorative trim. It works well as a trim piece for wallpaper or to add a decorative pattern to flat panels. This profile can also be used to put a rounded edge on various shelving.

Stock Code	Dimensions
120	1/2" x 1" x RL PIN
2448HRPOP	3/4" x 1 1/2" x RL POP

MISCELLANEOUS

GLASS & SASH BEADS

Narrow wood strips or moulding used for edging against a door or window sash, or to secure glass panels to doors and windows.

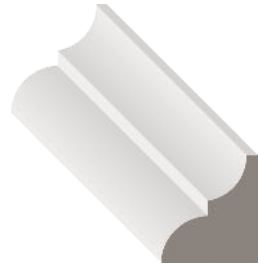

Stock Code **147** Dimensions $\frac{1}{2}'' \times \frac{3}{16}'' \times \text{RL}$
PIN

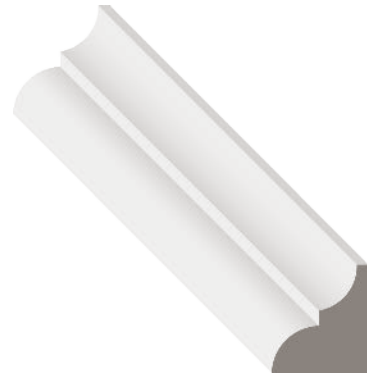

Stock Code **148** Dimensions $\frac{3}{8}'' \times \frac{3}{8}'' \times \text{RL}$
PIN



Stock Code **2323BPOP** Dimensions $\frac{3}{4}'' \times \frac{3}{4}'' \times \text{RL}$
POP



Stock Code **5039POP** Dimensions $\frac{7}{16}'' \times \frac{5}{8}'' \times \text{RL}$
POP

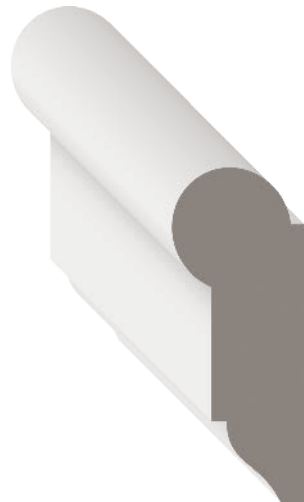

PICTURE MOULD

A narrow moulding along the perimeter of the walls near the ceiling line traditionally used to support hooks for picture hanging.

Stock Code **273L** Dimensions $\frac{5}{8}'' \times 1\frac{1}{4}'' \times \text{RL}$
PIN

MULLIONS

The upright or vertical member dividing the panels in a door. A mullion is also the vertical member of a sash, window or door frame between openings in a multiple opening frame. The mullion is known as the mullion center. Frames are termed mullions, triples or quadruples, depending on whether they have one, two or three mullions, respectively. On doors, they are sometimes referred to as muntins.



Stock Code **972** Dimensions $\frac{3}{8}'' \times 2'' \times \text{RL}$
PIN



Stock Code **974** Dimensions $\frac{3}{8}'' \times 1\frac{3}{8}'' \times \text{RL}$
PIN

LATTICE

A thin strip of flat moulding commonly used to hide seams and edges.

Stock Code	Dimensions
260	$\frac{1}{4}'' \times 5\frac{1}{2}'' \times \text{RL}$ PIN
2600	$\frac{1}{4}'' \times 5\frac{1}{2}'' \times \text{RL}$ O
260POP	$\frac{1}{4}'' \times 5\frac{1}{2}'' \times \text{RL}$ POP
262	$\frac{1}{4}'' \times 2\frac{1}{2}'' \times \text{RL}$ PIN
264	$\frac{1}{4}'' \times 2'' \times \text{RL}$ PIN

Stock Code	Dimensions
2640	$\frac{3}{16}'' \times 2'' \times \text{RL}$ O
264POP	$\frac{3}{16}'' \times 2'' \times \text{RL}$ POP
264PRI	$\frac{1}{4}'' \times 2'' \times 16'$ PRI
265	$\frac{1}{4}'' \times 1\frac{3}{4}'' \times \text{RL}$ PIN
265F08	$\frac{1}{4}'' \times 1\frac{3}{4}'' \times 8'$ PIN

Stock Code	Dimensions
267	$\frac{1}{4}'' \times 1\frac{3}{8}'' \times \text{RL}$ PIN
267F08	$\frac{1}{4}'' \times 1\frac{3}{8}'' \times 8'$ PIN
267LPOPFO7	$\frac{1}{4}'' \times 1\frac{1}{4}'' \times 7'$ POP
268	$\frac{1}{4}'' \times 1\frac{1}{8}'' \times \text{RL}$ PIN
268F08	$\frac{1}{4}'' \times 1\frac{1}{8}'' \times 8'$ PIN

QUARTER ROUNDS

Quarter rounds come in several sizes and serve a variety of functions. They are most often used with baseboards.

Stock Code	Dimensions
103	$1\frac{1}{16}'' \times 1\frac{1}{16}'' \times \text{RL}$ PIN
105	$\frac{3}{4}'' \times \frac{3}{4}'' \times \text{RL}$ PIN
105F08	$\frac{3}{4}'' \times \frac{3}{4}'' \times 8'$ PIN
105POP	$\frac{3}{4}'' \times \frac{3}{4}'' \times \text{RL}$ POP

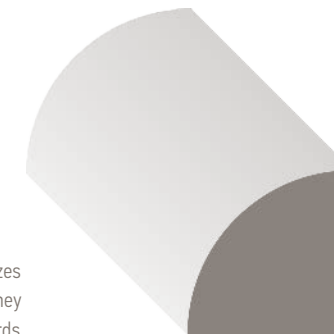

Stock Code **106** Dimensions $1\frac{1}{16}'' \times 1\frac{1}{16}'' \times \text{RL}$
PIN

Stock Code **106P** Dimensions $1\frac{1}{16}'' \times 1\frac{1}{16}'' \times 16'$
FPP

Stock Code **108** Dimensions $\frac{1}{2}'' \times \frac{1}{2}'' \times \text{RL}$
PIN

Stock Code **110** Dimensions $\frac{1}{4}'' \times \frac{1}{4}'' \times \text{RL}$
PIN



Stock Code **1060** Dimensions $\frac{3}{4}'' \times \frac{3}{4}'' \times \text{RL}$
O

MISCELLANEOUS

ROSETTES

A raised decorative wood design in the shape of a flower used at the intersection of two materials, forming a decorative border. Sometimes rosettes are used on flush doors for a custom look.

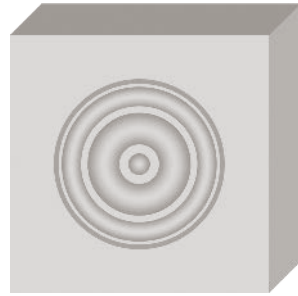

Stock Code Dimensions
R734CBO 7/8" x 3 1/2" x 3 1/2"
0

Stock Code Dimensions
R761CBO 7/8" x 2 5/8" x 2 5/8"
0

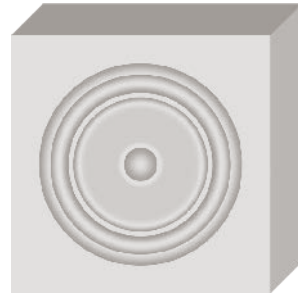

Stock Code Dimensions
RCB3BPOP 1 1/16" x 3 1/2" x 3 1/2"
POP

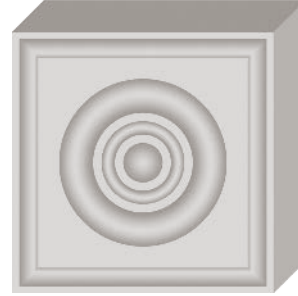

Stock Code Dimensions
RCB3B0 1 1/16" x 3 1/2" x 3 1/2"
0

Stock Code Dimensions
R734CBPOP 7/8" x 3 1/2" x 3 1/2"
POP

Stock Code Dimensions
R761CBPOP 7/8" x 2 5/8" x 2 5/8"
POP

Stock Code Dimensions
RCB334BPOP 1 1/16" x 3 3/4" x 3 3/4"
POP

Stock Code Dimensions
R740CBPOP 7/8" x 4 1/2" x 4 1/2"
POP

Stock Code Dimensions
R789CBO 7/8" x 3 3/4" x 3 3/4"
0

Stock Code Dimensions
RCB44BPOP 1 1/16" x 4" x 4"
POP

Stock Code Dimensions
R755CBPOP 1 1/8" x 5 1/2" x 5 1/2"
POP

Stock Code Dimensions
R789CBPOP 7/8" x 3 3/4" x 3 3/4"
POP

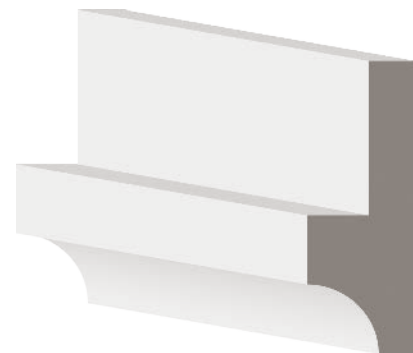

SHELF CLEAT

Affixed to walls of closets or pantries to hold up shelving boards.

Stock Code Dimensions
990LFJ 9/16" x 1 1/16" x 16'
FJP



SQUARE

Squares are used in the framing of shelves and cabinets, or are used to build up other profiles. Its uses are mostly utilitarian.

Stock Code Dimensions
239 3/4" x 3/4" x 16'
PIN



STAIR NOSING

The usually rounded edge of a stair tread that projects over the riser.

Stock Code Dimensions
200WCPOP 3/4" x 2" x RL
POP

SKIRT BOARDS

A long board that trims under the balustrade on the wall or stringer below a staircase.



Stock Code Dimensions
10663SBM* 5/8" x 11 1/4" x 16'
MDF/UL



Stock Code Dimensions
10623SBM* 5/8" x 11 1/4" x 16'
MDF/UL

MISCELLANEOUS

SHINGLE MOULD

Originally used on the rake of a building or around exterior window frames. May also be used in applications similar to panel moulds.

Stock Code Dimensions
210P 1 1/16" x 1 5/8" x 16'
FPP

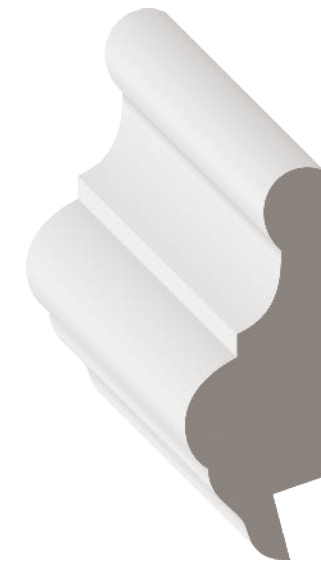

Stock Code Dimensions
2464PMPPOP 3/4" x 2" x RL
POP

WAINSCOT CAPS

A wainscot cap is used to finish the top edge of a wainscot wall treatment. It may also be used as one component of a larger chair rail profile.



Stock Code Dimensions
292L 5/8" x 1 1/8" x RL
PIN

Collection	Scene	Application	Item Number	Lengths (Ft.)	Species	Dimensions (Height)	Dimensions (Width)	Page No.
	N/A	IKON™	CFFROSPOP	N/A	POPLAR	4" OR 6"	4" OR 6"	12
	III	CROWN	CFF3W2SPO	RL	POPLAR	8"	2 3/4"	12
	III	CROWN	CFF3W1SPO	RL	POPLAR	6"	1 1/16"	13
	III	PANEL MOULD	CFF3P1SPO	RL	POPLAR	2"	1"	13
	III	CHAIR RAIL	CFF3L1SPO	RL	POPLAR	4"	1"	12
	III	CASING	CFF3C2SPO	RL	POPLAR	6"	1 1/2"	13
	III	CASING	CFF3C1SPO	RL	POPLAR	4"	1 1/16"	12
	III	BASEBOARD	CFF3B2SPO	RL	POPLAR	9"	1"	13
	III	BASEBOARD	CFF3B1SPO	RL	POPLAR	6"	3/4"	13
	III	ARCHITRAVE	CFF3A1SPO	RL	POPLAR	8"	1 3/4"	13
	II	CROWN	CFF2W2PMD	8, 12, 16	MDF	7 1/8"	1 1/4"	14
	II	CROWN	CFF2W1PMD	8, 12, 16	MDF	5 11/16"	1"	14
	II	PANEL MOULD	CFF2P1PMD	8, 12	MDF	1 1/8"	1/2"	15
	II	CHAIR RAIL	CFF2L1PMD	8, 12	MDF	4"	3/4"	15
	II	CASING	CFF2C2PMD	8, 12	MDF	4 1/4"	1"	15
	II	CASING	CFF2C1PMD	8, 12	MDF	3 1/2"	1"	15
	II	BASEBOARD	CFF2B2PMD	8, 12, 16	MDF	7 1/4"	3/4"	14
	II	BASEBOARD	CFF2B1PMD	8, 12, 16	MDF	5 1/2"	3/4"	15
	II	ARCHITRAVE	CFF2A1PMD	8, 12	MDF	3 1/2"	1 1/2"	15
	I	CROWN	CFF1W2PMD	8, 12, 16	MDF	5 1/4"	3/4"	17
	I	CROWN	CFF1W1PMD	8, 12, 16	MDF	4 1/4"	3/4"	17
	I	CASING	CFF1C2PMD	8, 12	MDF	3 1/2"	3/4"	17
	I	CASING	CFF1C1PMD	8, 12	MDF	2 3/4"	3/4"	16
	I	BASEBOARD	CFF1B2PMD	8, 12, 16	MDF	5 1/2"	5/8"	16
	I	BASEBOARD	CFF1B1PMD	8, 12, 16	MDF	4 1/4"	5/8"	16

FASHION FORWARD™

	N/A	IKON™	CFCROSPOP	N/A	POPLAR	4" OR 6"	4" OR 6"	22
	III	CROWN	CFC3W2SPO	RL	POPLAR	8"	3 5/8"	23
	III	CROWN	CFC3W1SPO	RL	POPLAR	6"	3"	23
	III	PANEL MOULD	CFC3P1SPO	RL	POPLAR	1 7/8"	5/8"	23
	III	CHAIR RAIL	CFC3L1SPO	RL	POPLAR	4 1/4"	3/4"	23
	III	CASING	CFC3C2SPO	RL	POPLAR	3 1/2"	1 1/16"	22
	III	CASING	CFC3C1SPO	RL	POPLAR	4 1/4"	1 1/16"	22
	III	BASEBOARD	CFC3B2SPO	RL	POPLAR	9 1/4"	3/4"	23
	III	BASEBOARD	CFC3B1SPO	RL	POPLAR	7 1/4"	3/4"	22
	III	ARCHITRAVE	CFC3A1SPO	RL	POPLAR	7 1/4"	2"	23
	II	CROWN	CFC2W2SPO	RL	POPLAR	5 1/4"	3/4"	25
	II	CROWN	CFC2W1SPO	RL	POPLAR	7 1/4"	3/4"	25
	II	PANEL MOULD	CFC2P1SPO	RL	POPLAR	1 1/2"	9/16"	25
	II	CHAIR RAIL	CFC2L1SPO	RL	POPLAR	2"	1 1/16"	25
	II	CASING	CFC2C2SPO	RL	POPLAR	4 1/4"	1"	24
	II	CASING	CFC2C1SPO	RL	POPLAR	3 1/2"	1"	24
	II	BASEBOARD	CFC2B2SPO	RL	POPLAR	7 1/4"	3/4"	24
	II	BASEBOARD	CFC2B1SPO	RL	POPLAR	9 1/4"	3/4"	25
	II	ARCHITRAVE	CFC2A1SPO	RL	POPLAR	5 5/16"	1 1/16"	24
	I	CROWN	CFC1W2PMD	8, 12, 16	MDF	7 1/4"	1 3/16"	26
	I	CROWN	CFC1W1PMD	8, 12, 16	MDF	5 1/4"	3/4"	26
	I	PANEL MOULD	CFC1P1PMD	8, 12	MDF	1 1/8"	1/2"	26
	I	CHAIR RAIL	CFC1L1PMD	8, 12	MDF	3 1/4"	1"	27
	I	CASING	CFC1C2PMD	8, 12	MDF	3 1/2"	1"	26
	I	CASING	CFC1C1PMD	8, 12	MDF	2 3/4"	1"	26
	I	BASEBOARD	CFC1B2PMD	8, 12, 16	MDF	5 1/2"	3/4"	27
	I	BASEBOARD	CFC1B1PMD	8, 12, 16	MDF	4 1/4"	3/4"	27
	I	ARCHITRAVE	CFC1A1PMD	8, 12	MDF	5 1/2"	1 1/2"	27

FRENCH CURVES™

Collection	Scene	Application	Item Number	Lengths (Ft.)	Species	Dimensions (Height)	Dimensions (Width)	Page No.
	N/A	IKON™	CPSROSPOP	N/A	POPLAR	4" OR 6"	4" OR 6"	32
	II	CROWN	CPS2W2SRO	RL	RED OAK	6 3/8"	1"	32
	II	CROWN	CPS2W1SRO	RL	RED OAK	4 1/4"	3/4"	33
	II	PANEL MOULD	CPS2P1SRO	RL	RED OAK	1 1/2"	1/2"	33
	II	CHAIR RAIL	CPS2L1SRO	RL	RED OAK	2 5/8"	9/16"	32
	II	CASING	CPS2C2SRO	RL	RED OAK	4 1/4"	1"	33
	II	CASING	CPS2C1SRO	RL	RED OAK	3 1/4"	13/16"	33
	II	BASEBOARD	CPS2B2SRO	RL	RED OAK	7 1/4"	3/4"	33
	II	BASEBOARD	CPS2B1SRO	RL	RED OAK	5 1/4"	3/4"	33
	II	ARCHITRAVE	CPS2A1SRO	RL	RED OAK	5 5/16"	1 1/16"	32
	I	CROWN	CPS1W2PMD	8, 12, 16	MDF	5 1/4"	5/8"	35
	I	CROWN	CPS1W1PMD	8, 12, 16	MDF	4 1/4"	5/8"	35
	I	PANEL MOULD	CPS1P1PMD	8, 12	MDF	1 1/2"	9/16"	34
	I	CHAIR RAIL	CPS1L1PMD	8, 12	MDF	2 1/2"	5/8"	35
	I	CASING	CPS1C2PMD	8, 12	MDF	3 3/8"	1"	35
	I	CASING	CPS1C1PMD	8, 12	MDF	2 3/4"	1"	35
	I	BASEBOARD	CPS1B2PMD	8, 12, 16	MDF	7 1/4"	3/4"	34
	I	BASEBOARD	CPS1B1PMD	8, 12, 16	MDF	5 1/4"	3/4"	34

PRETTY SIMPLE™

	N/A	IKON™	CTCROSPOP	N/A	POPLAR	4" OR 6"	4" OR 6"	40
	III	CROWN	CTC3W2VFI	RL	(VG) FIR	8 13/16"	5 7/16"	43
	III	CROWN	CTC3W1VFI	RL	(VG) FIR	7"	4 1/2"	43
	III	PANEL MOULD	CTC3P1VFI	RL	(VG) FIR	3 1/2"	3/4"	41
	III	CHAIR RAIL	CTC3L1VFI	RL	(VG) FIR	5 1/2"	5/8"	42
	III	CASING	CTC3C4VFI	RL	(VG) FIR	5 1/2"	1 3/4"	40
	III	CASING	CTC3C3VFI	RL	(VG) FIR	5 1/2"	1 7/16"	41
	III	CASING	CTC3C2VFI	RL	(VG) FIR	3 1/2"	1 3/8"	40
	III	CASING	CTC3C1VFI	RL	(VG) FIR	3 1/2"	1 3/8"	42
	III	BASEBOARD	CTC3B2VFI	RL	(VG) FIR	9 1/4"	1"	41
	III	BASEBOARD	CTC3B1VFI	RL	(VG) FIR	7 1/4"	1"	42
	III	ARCHITRAVE	CTC3A1VFI	RL	(VG) FIR	7 1/4"	1 3/4"	43
	II	CROWN	CTC2W2MFI	RL	FIR	7 1/4"	3/4"	45
	II	CROWN	CTC2W1MFI	RL	FIR	4 1/4"	5/8"	45
	II	CHAIR RAIL	CTC2L1MFI	RL	FIR	3 1/2"	3/4"	45
	II	CASING	CTC2C2MFI	RL	FIR	4 1/2"	1"	44
	II	CASING	CTC2C1MFI	RL	FIR	3 1/2"	1"	44
	II	BASEBOARD	CTC2B2MFI	RL	FIR	7 1/4"	3/4"	44
	II	BASEBOARD	CTC2B1MFI	RL	FIR	5 1/4"	3/4"	44
	II	ARCHITRAVE	CTC2A1MFI	RL	FIR	7 1/4"	1 7/16"	45
	I	CROWN	CTC1W2PMD	8, 12, 16	MDF	5 1/4"	1 1/2"	46
	I	CROWN	CTC1W1PMD	8, 12, 16	MDF	4 1/4"	1 1/2"	46
	I	CASING	CTC1C2PMD	8, 12	MDF	3 1/2"	1"	47
	I	CASING	CTC1C1PMD	8, 12	MDF	2 3/4"	1"	47
	I	BASEBOARD	CTC1B2PMD	8, 12, 16	MDF	5 3/4"	3/4"	46
	I	BASEBOARD	CTC1B1PMD	8, 12, 16	MDF	4"	3/4"	47
	I	ARCHITRAVE	CTC1A1PMD	8, 12	MDF	5"	1 1/2"	47

TRUE CRAFT™

	N/A	IKON™	CVSROSPOP	N/A	POPLAR	4" OR 6"	4" OR 6"	52
	III	CROWN	CVS3W2SWO	RL	WHITE OAK	8"	2"	53
	III	CROWN	CVS3W1SWO	RL	WHITE OAK	6"	3"	53
	III	PANEL MOULD	CVS3P1SWO	RL	WHITE OAK	2"	3/4"	53
	III	CHAIR RAIL	CVS3L1SWO	RL	WHITE OAK	3"	3/4"	53
	III	CASING	CVS3C2SWO	RL	WHITE OAK	4 1/2"	1"	52
	III	CASING	CVS3C1SWO	RL	WHITE OAK	3 1/2"	1/2"	53
	III	BASEBOARD	CVS3B2SWO	RL	WHITE OAK	6 1/2"	3/4"	52
	III	BASEBOARD	CVS3B1SWO	RL	WHITE OAK	3 1/2"	3/4"	53
	II	CROWN	CVS2W2PMD	8, 12, 16	MDF	7 3/4"	1 1/4"	55
	II	CROWN	CVS2W1PMD	8, 12, 16	MDF	6 1/4"	1 1/4"	55
	II	PANEL MOULD	CVS2P1PMD	8, 12	MDF	2"	1/2"	55
	II	CHAIR RAIL	CVS2L1PMD	8, 12	MDF	3 1/2"	1"	54
	II	CASING	CVS2C2PMD	8, 12	MDF	4 1/2"	1"	54
	II	CASING	CVS2C1PMD	8, 12	MDF	3 1/2"	1"	55
	II	BASEBOARD	CVS2B2PMD	8, 12, 16	MDF	7 1/4"	3/4"	54
	II	BASEBOARD	CVS2B1PMD	8, 12, 16	MDF	5 1/2"	3/4"	54
	II	ARCHITRAVE	CVS2A1PMD	8, 12	MDF	6 1/2"	1 1/2"	55
	I	CROWN	CVS1W2PMD	8, 12, 16	MDF	7"	1 3/16"	56
	I	CROWN	CVS1W1PMD	8, 12, 16	MDF	5 7/16"	1 3/16"	56
	I	CASING	CVS1C2PMD	8, 12	MDF	3 1/2"	3/4"	57
	I	CASING	CVS1C1PMD	8, 12	MDF	2 3/4"	3/4"	57
	I	BASEBOARD	CVS1B2PMD	8, 12, 16	MDF	5 1/2"	9/16"	56
	I	BASEBOARD	CVS1B1PMD	8, 12, 16	MDF	4 1/2"	9/16"	57

VERY SQUARE™

Then & Now Finishing Collections™

INDEX

Stock Code	Profile Type	Dimensions	Species	Page
22136CBO	Baseboard	1/4" x 4 1/4" x RL	O	76
22168CB	Baseboard	1/4" x 5 1/4" x RL	PIN	76
22168CBO	Baseboard	1/4" x 5 1/4" x RL	O	76
22168EBO	Baseboard	1/4" x 5 1/4" x RL	O	78
22232CBO	Baseboard	1/4" x 7 1/4" x RL	O	76
24112CAJ	Architrave	1/4" x 3 1/2" x 16'	FJP	63
24112CAM	Architrave	1/4" x 3 1/2" x 16'	MDF/UL	63
24112CCAM	Casing	3/4" x 3 1/2" x RL	MDF/UL	94
24112CCAO	Casing	3/4" x 3 1/2" x RL	O	98
24112CCLJ	Casing	5/8" x 3 1/2" x RL	FPP	94
24112ECAM	Casing	3/4" x 3 1/2" x 16'	MDF/UL	102
24112PCAJ	Casing	1/4" x 3 1/2" x RL	FPP	100
24112PCAJ190	Casing	1/4" x 3 1/2" x 90"	FPP	100
24112PCAJ1102	Casing	1/4" x 3 1/2" x 102"	FPP	100
24112PCAM	Casing	3/4" x 3 1/2" x RL	MDF/UL	100
24112PCAMDF	Casing	3/4" x 3 1/2" x 16'	MDF/UL	100
24112PCAMI102	Casing	1/4" x 3 1/2" x 102"	MDF/UL	100
24112PCAO	Casing	3/4" x 3 1/2" x RL	O	100
24112PCAO190	Casing	3/4" x 3 1/2" x 90"	O	100
24136ACRM	Crown	3/4" x 4 1/4" x 16'	MDF/UL	119
24136CCRPOP	Crown	3/4" x 4 1/4" x 16'	POP	113
24136CCRPRI	Crown	3/4" x 4 1/4" x 16'	PRI	113
24136ECAM	Casing	3/4" x 4 1/4" x 16'	MDF/UL	102
24136RFAFJP	Casing	3/4" x 4 1/4"	PRI	105
24168ACRM	Crown	3/4" x 5 1/4" x 16'	MDF/UL	119
24168CCRM	Crown	3/4" x 5 1/4" x 16'	MDF/UL	120
24168CCRPOP	Crown	3/4" x 5 1/4" x RL	POP	113
24168CCRPRI	Crown	3/4" x 5 1/4" x 16'	PRI	113
24168FCAPOP	Casing	3/4" x 5 3/4"	POP	105
24168ACRPRI	Crown	3/4" x 5 1/4" x 16'	PRI	117
26192CRO	Crown	3/4" x 6" x RL	O	118
26192CRPOP	Crown	3/4" x 6" x RL	POP	118
26192CRPRI	Crown	3/4" x 6" x 16'	PRI	118
28192CRM	Crown	7/8" x 6" x 16'	MDF/UL	123
32104CHM	Chair Rail	1" x 3 1/4" x 16'	MDF/UL	107
32104CHP	Chair Rail	1" x 3 1/4" x 16'	FPP	107
32104CHPOP	Chair Rail	1" x 3 1/4" x RL	POP	107
32104CHPRI	Chair Rail	1" x 3 1/4" x 16'	PRI	107
32112CAM	Casing	1" x 3 1/2" x 16'	MDF/UL	99
32242CRM	Crown	7/8" x 7 1/4" x 16'	MDF/UL	118
34112HCAPRI	Architrave	1/4" x 3 1/2" x 16'	PRI	62
34136CAPOP	Casing	1 1/4" x 4 1/4" x RL	POP	103
34136CAPRI	Casing	1 1/4" x 4 1/4" x 15'	PRI	103
34232ACRM	Crown	1" x 7 1/4" x 16'	MDF/UL	117
34232ACRPRI	Crown	1 1/4" x 7 1/4" x 16'	PRI	117
34232BCRPOP	Crown	1 1/4" x 7 3/4" x RL	POP	115
561440	Bar Rail	1 3/4" x 4 1/2" x RL	O	141
BB170	Plinth Block	1 1/4" x 7" x RL	O	136
BB17POP	Plinth Block	1 1/4" x 7" x RL	POP	136
BB110POP	Plinth Block	1 1/4" x 10"	POP	136
BB07POP	Plinth Block	1 1/4" x 1 1/4" x 7"	POP	136

Stock Code	Profile Type	Dimensions	Species	Page
BB010POP	Plinth Block	1 1/4" x 10" x RL	POP	136
FJS4RCE	Jamb	1/16" x 4 9/16" x 14'	PEC	131
FJS4RPP	Jamb	1/16" x 4 9/16" x 16'	FPP	131
FJS4RPPRI	Jamb	1/16" x 4 5/8" x 16'	PRI	131
FJS4110WV	Jamb	3/16" x 4 1/16" x 81 1/16"	OV	131
FJS458RP	Jamb	1/16" x 4 5/8" x 81 1/16"	FPP	131
FJS481CE	Jamb	1/16" x 4 9/16" x 81 1/16"	PEC	131
FJS481J	Jamb	1/16" x 4 9/16" x 81 1/16"	FPP	131
FJS481M	Jamb	1/16" x 4 5/8" x 81 1/16"	MDF/UL	131
FJS481OVWC	Jamb	1/16" x 4 9/16" x 81 1/16"	OV	131
FJS481OVV	Jamb	1/16" x 4 9/16" x 81 1/16"	OV	131
FJS481P	Jamb	1/16" x 4 5/8" x 81 1/16"	FPP	131
FJS481PJ	Jamb	1/16" x 4 9/16" x 81 1/16"	FPP	131
FJS481POP	Jamb	1/16" x 4 9/16" x 81 1/16"	POP	131
FJS481PRI	Jamb	1/16" x 4 9/16" x 81 1/16"	PRI	131
FJS481WV	Jamb	1/16" x 4 9/16" x 81 1/16"	PINV	131
FJS481WVWC	Jamb	1/16" x 4 9/16" x 81 1/16"	PINV	131
FJS497P	Jamb	1/16" x 4 9/16" x 97 1/16"	FPP	131
FJS497POP	Jamb	1/16" x 4 9/16" x 97 1/16"	POP	131
FJS497PRI	Jamb	1/16" x 4 9/16" x 97 1/16"	PRI	131
FJS581P	Jamb	1/16" x 5 1/4" x 81 1/16"	FPP	131
FJS681CE	Jamb	1/16" x 6 9/16" x 81 1/16"	PEC	131
FJS681P	Jamb	1/16" x 6 5/8" x 81 1/16"	FPP	131
FJS681PRI	Jamb	1/16" x 6 9/16" x 81 1/16"	PRI	131
FJS697P	Jamb	1/16" x 6 5/8" x 97 1/16"	FPP	131
FJS697POP	Jamb	1/16" x 6 5/8" x 97 1/16"	POP	131
FJS697PRI	Jamb	1/16" x 6 5/8" x 97 1/16"	PRI	131
FJS5081P	Jamb	1/16" x 5" x 81 1/16"	FPP	131
FJS5097P	Jamb	1/16" x 5" x 97 1/16"	FPP	131
FJS47881CE	Jamb	1/16" x 4 13/16" x 81 1/16"	PEC	131
FJS47881J	Jamb	1/16" x 4 7/8" x 81 1/16"	FPP	131
FJS47881M	Jamb	1/16" x 4 7/8" x 81 1/16"	MDF/UL	131
FJS47881OVV	Jamb	1/16" x 4 7/8" x 81 1/16"	OV	131
FJS47881P	Jamb	1/16" x 4 7/8" x 81 1/16"	FPP	131
FJS47881PRI	Jamb	1/16" x 4 7/8" x 81 1/16"	PRI	131
FJS47881WV	Jamb	1/16" x 4 13/16" x 81 1/16"	PINV	131
FJS47885P	Jamb	1/16" x 4 7/8" x 85 1/16"	FPP	131
FJS47897P	Jamb	1/16" x 4 7/8" x 97 1/16"	FPP	131
FJS47897POP	Jamb	1/16" x 4 7/8" x 97 1/16"	POP	131
FJS47897PRI	Jamb	1/16" x 4 7/8" x 97 1/16"	PRI	131
FJS67881P	Jamb	1/16" x 6 7/8" x 81 1/16"	FPP	131
FJS67897P	Jamb	1/16" x 6 7/8" x 97 1/16"	FPP	131
PB7420	Plinth Block	1 1/4" x 3 1/2" x 6 1/2"	O	136
PB742POP	Plinth Block	1 1/4" x 3 1/2" x 6 1/2"	POP	136
PB7430	Plinth Block	1 1/4" x 4 1/2" x 8"	O	136
PB743POP	Plinth Block	1 1/4" x 4 1/2" x 8"	POP	136
PB795POP	Plinth Block	1 1/4" x 5 1/2" x 9 1/4"	POP	136
PB8160	Plinth Block	1 1/4" x 3 3/4" x 6 1/2"	O	136
PB816POP	Plinth Block	1 1/4" x 3 3/4" x 6 1/2"	POP	136
PVC180-18	Brick Mould	1 1/2" x 2" x 18"	PVC	142
R734CBO	Rosette	7/8" x 3 1/2" x 3 1/2"	O	146

INDEX

Stock Code	Profile Type	Dimensions	Species	Page
R734CBPOP	Rosette	7/8" x 3 1/2" x 3 1/2"	POP	146
R740CBPOP	Rosette	7/8" x 4 1/2" x 4 1/2"	POP	146
R755CBPOP	Rosette	1 1/8" x 5 1/2" x 5 1/2"	POP	146
R761CBO	Rosette	7/8" x 2 5/8" x 2 5/8"	O	146
R761CBPOP	Rosette	7/8" x 2 5/8" x 2 5/8"	POP	146
R789CBO	Rosette	7/8" x 3 3/4" x 3 3/4"	O	146
R789CBPOP	Rosette	7/8" x 3 3/4" x 3 3/4"	POP	146
RCB3B0	Rosette	1 1/4" x 3 1/2" x 3 1/2"	O	146
RCB3BPOP	Rosette	1 1/4" x 3 1/2" x 3 1/2"	POP	146
RCB44BPOP	Rosette	1 1/4" x 4" x 4"	POP	146
RCB334BPOP	Rosette	1 1/4" x 3 3/4" x 3 3/4"	POP	146
SJS481	Jamb	1 5/8" x 4 5/8" x 81 13/16"	PIN	131
SJS481FJ	Jamb	1 5/8" x 4 5/8" x 81 13/16"	FJP	131
SJS481J	Jamb	1 5/8" x 4 5/8" x 81 13/16"	FPP	131
SJS481P	Jamb	1 5/8" x 4 5/8" x 81 13/16"	FPP	131
SJS481WFJ	Jamb	1 1/4" x 4 5/8" x 81 13/16"	FJP	131
SJS481WJ	Jamb	1 5/8" x 4 5/8" x 81 13/16"	FPP	131
SJS481WP	Jamb	1 1/4" x 4 5/8" x 81 13/16"	FPP	131

Metrie™ is North America's leading manufacturer and distributor of interior finishings.
Our industry position has allowed us the resources, strength and leadership to
create solutions that make it easier for consumers and design professionals to select,
purchase and design with interior mouldings and doors.

To learn more about our company and our story, visit Metrie.com.



2200 WEST HAVEN AVENUE
NEW LENOX, IL 60451
T: 815.717.2660 F: 815.717.2651
TOLL-FREE: 800.244.1348

Metrie products distributed by: