

THE FINEST HARDWOOD MOULDINGS

NEW! *Architectural*
SERIES ●

Decorator Series

STANDARD SERIES

 **FIRERATED FRAMES**

Ferche also specializes in:

Door Components

Veneered Products

Floor Mouldings

OEM Products

Custom Mouldings/Parts

**FERCHE
MILLWORK**

Ferche Millwork, Inc.
400 Division St. North
Rice, MN 56367

800-328-7867 | Ferche.com

TABLE OF CONTENTS

100 SERIES : 3-8	bevel casing & flat casing 3-8 v.i.p. casing 7 brick mould, backband 8
200 SERIES : 9-14	baseboards 9-12 base shoe, base caps 12 veneered base, base corner blocks 13 corner/plinth blocks 14
300 SERIES : 15-21	door stop, astragals 15 veneered & solid door jambs 16 veneered & solid door frames 17-18 sidelight frame 18 fire-rated door frames 19-20 rabbeted jamb specification sheet 21
400 SERIES : 22-24	s4s & veneered boards 22 cabinet parts, bar rails 23 ez beam (ceiling beam system) 24
500 SERIES : 25	mull center, screen, stool, picture frame & hanger 25
600 SERIES : 26-34	coves, bed moulds 26 crowns 27-31 crowns with dentil mould 32 dentil mould 33 inside crown corner blocks, corner moulding 34
700 SERIES : 35-40	panel moulding 35-36 chair rail 37-38 tongue & groove paneling 39 mantel mouldings 40
800 SERIES : 40	thresholds 40
900 SERIES : 41-46	handrails, balusters 41 full rounds, half rounds 42 safety rails 43-44 stair parts 45 veneered skirt boards 46
1000 SERIES : 47	decorative handrails, shoe rails, fillet 47
COLLECTIONS : 48-58	decorator series 48-52 standard series 53-55 architectural series 56-58
DOOR & WINDOW TOPPERS : 59	plainsong, prairie & craftsman 59
CRAFTSMAN COLLECTION : 60	craftsman collection mouldings 60
BUILT-UP MOULDINGS : 61	built -up moulding components 61
FIREPLACE MANTELS : 62-64	fireplace mantel kits 62-64

BEVEL CASING

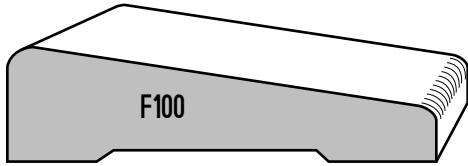

F100 - 9/16" X 2 1/4"

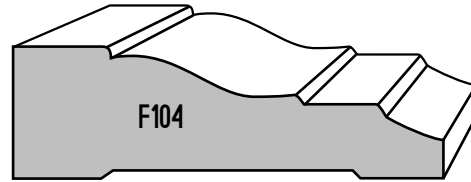

F104 - 11/16" X 2 1/4"

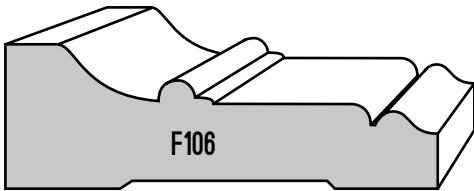

F106 - 3/4" X 2 1/4"

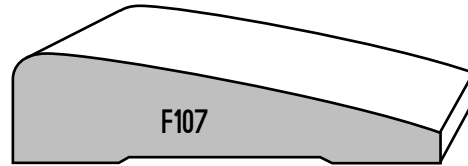

F107 - 5/8" X 2 1/4"

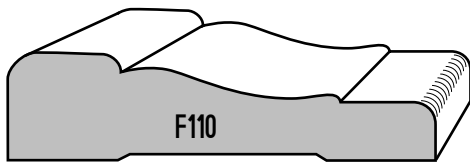

F110 - 9/16" X 2 1/4"

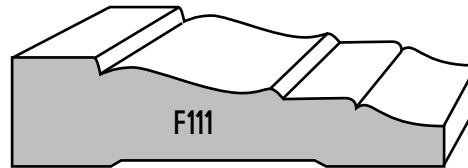

F111 - 9/16" X 2 1/4"

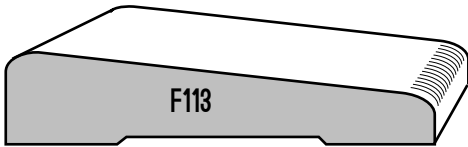

F113 - 1/2" X 2 1/4"

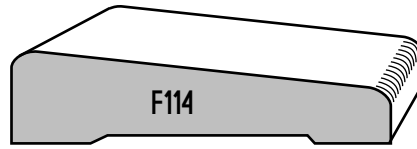

F114 - 1/2" X 2"

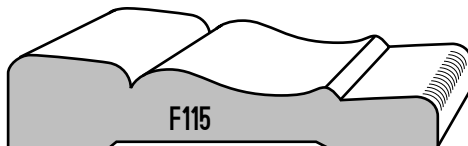

F115 - 1/2" X 2 1/4"

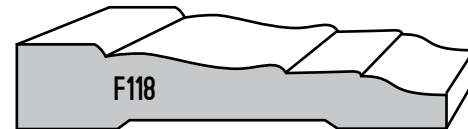

F118 - 1/2" X 2 1/4"

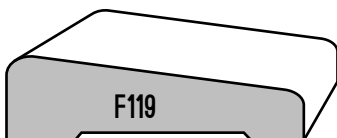

F119 - 1/2" X 1 5/8"

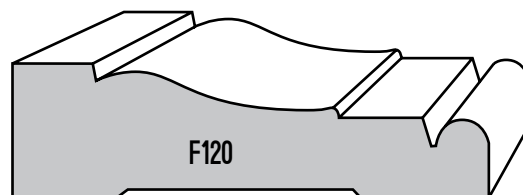

F120 - 3/4" X 2 1/2"

BEVEL CASING

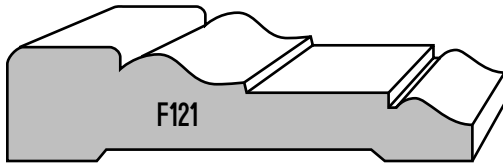

F121 - 5/8" X 2 1/2"

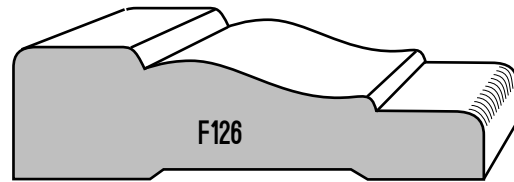

F126 - 11/16" X 2 1/2"

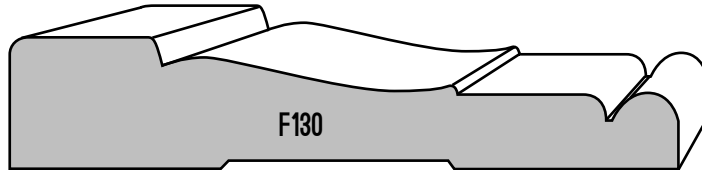

F130 - 11/16" X 3 1/2"

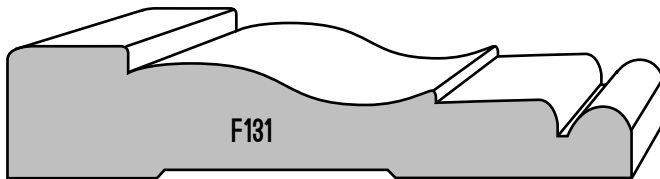

F131 - 11/16" X 3 1/4"

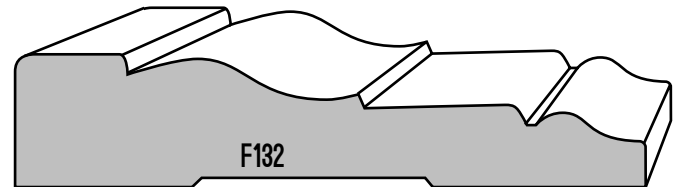

F132 - 11/16" X 3 1/4"

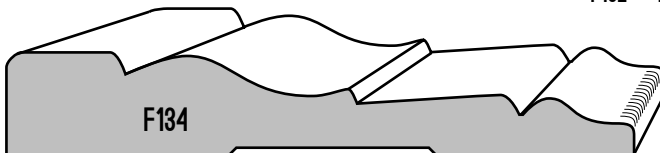

F134 - 9/16" X 3 1/4"

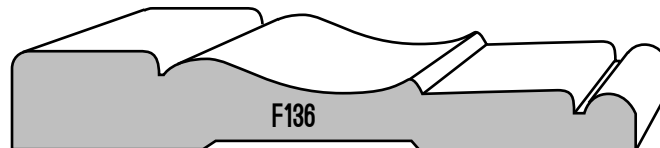

F136 - 1/2" X 3 1/4"

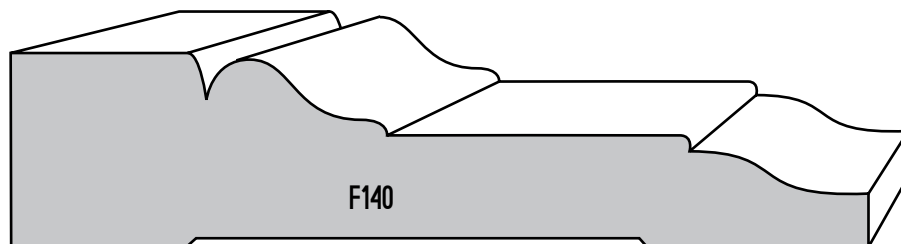

F140 - 1" X 4 1/2"

BEVEL CASING

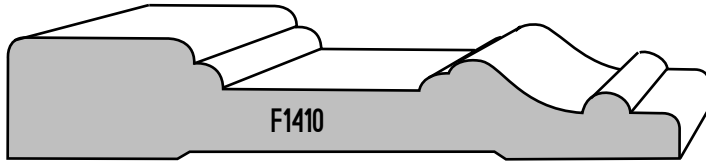

F1410 - 5/8" X 3 1/2"

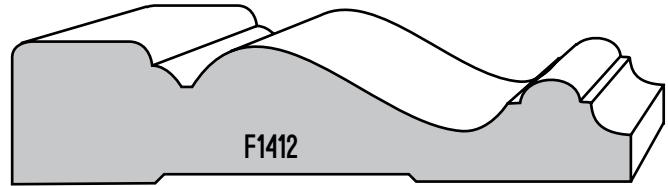

F1412 - 3/4" X 3 1/4"



F1420 - 3/4" X 3 1/4"

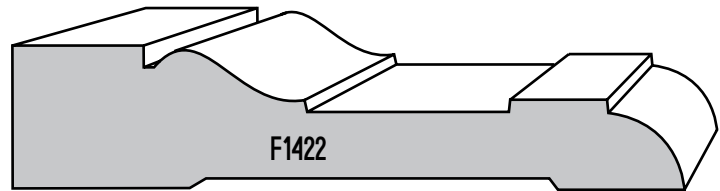

F1422 - 3/4" X 3 1/2"

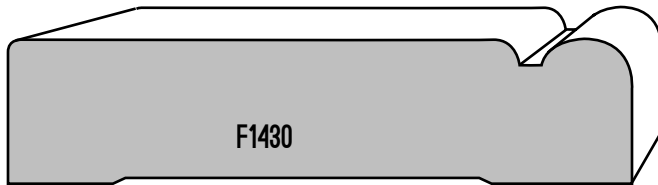

F1430 - 3/4" X 3 1/4"

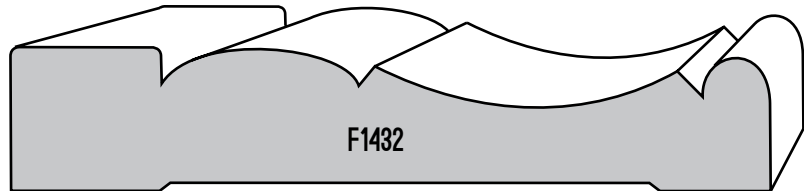

F1432 - 3/4" X 4"

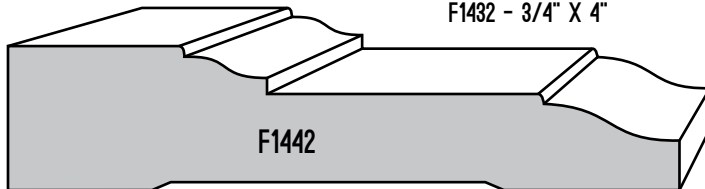

F1442 - 3/4" X 3 1/2"

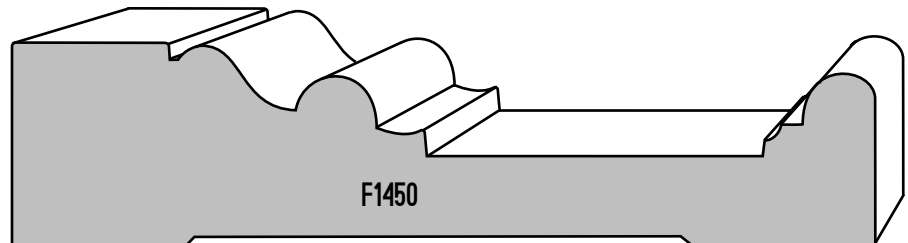

F1450 - 1 1/16" X 4 1/2"

CASING

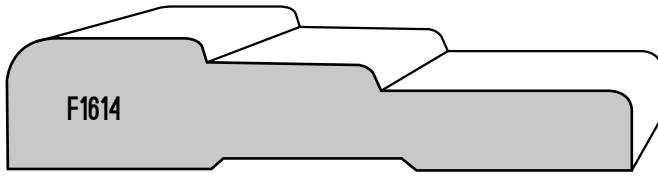

F1614 - 11/16" X 3 1/4"

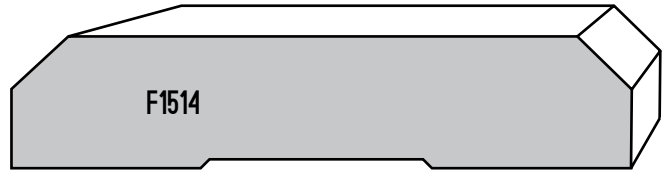

F1514 - 11/16" X 3 1/4"



F1644 - 11/16" X 3 1/4"

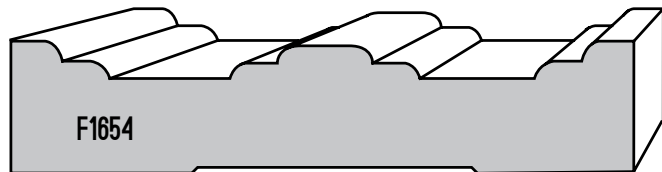

F1654 - 11/16" X 3 1/4"

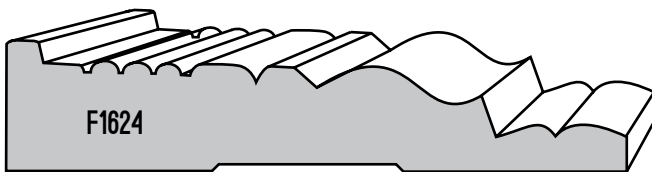

F1624 - 11/16" X 3 1/4"

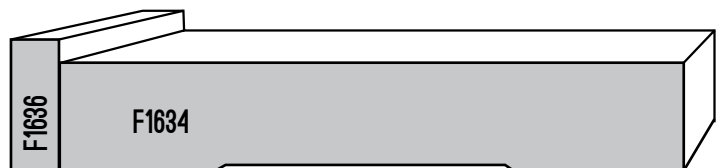

F1634 - 9/16" X 3 1/4"
F1636 CASING CAP - 1/4" X 11/16"

V.I.P. CASING

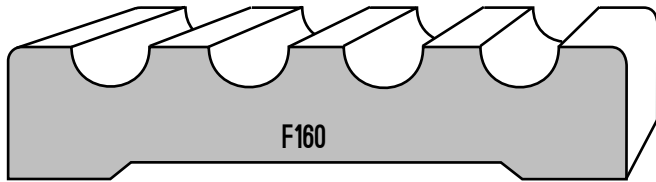

F160 - 11/16" X 3 1/4"

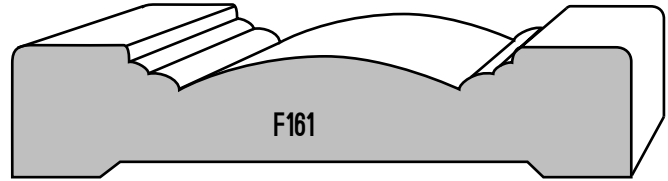

F161 - 11/16" X 3 1/4"

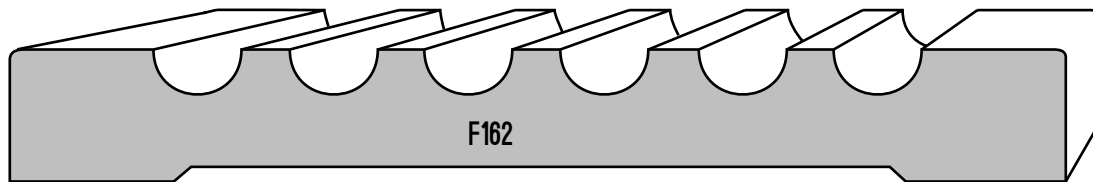

F162 - 11/16" X 5 1/2"

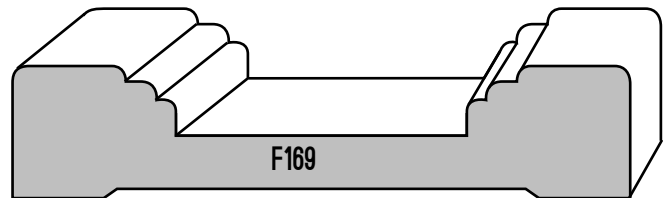

F169 - 11/16" X 3 1/4"

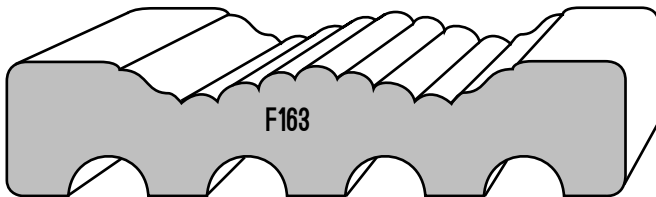

F163 - 11/16" X 3 1/4"

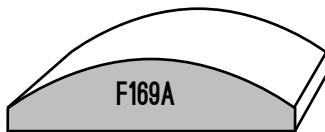

F169A - 3/8" X 1 1/2"

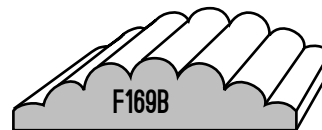

F169B - 3/8" X 1 1/2"

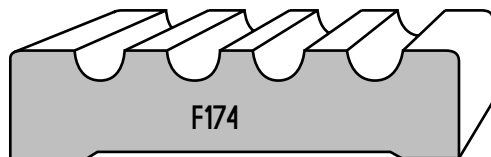

F174 - 9/16" X 2 3/8"

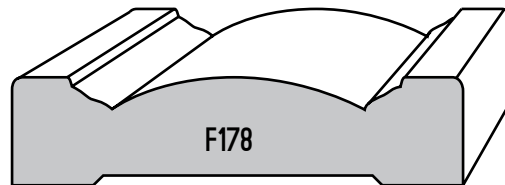

F178 - 9/16" X 2 3/8"

FLAT CASING/HOOK STRIP

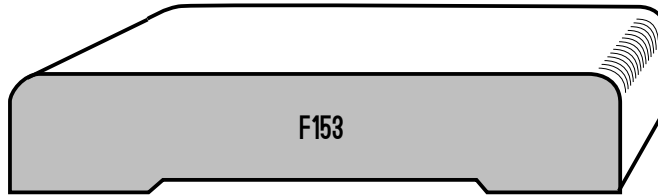

F153 - 11/16" X 3 1/4"

PROFILE #	DIMENSIONS	PROFILE #	DIMENSIONS	PROFILE #	DIMENSIONS
F156	7/16" X 2-1/4"	F1544	1/2" X 3-1/4"	F159	11/16" X 2-1/2"
F1561	7/16" X 2-1/2"	F1545	1/2" X 3-1/2"	F1582	11/16" X 3"
F1562	7/16" X 3"	F157	9/16" X 2-1/4"	F153	11/16" X 3-1/4"
F1563	7/16" X 3-1/4"	F154	9/16" X 2-1/2"	F1584	11/16" X 3-1/2"
F1564	7/16" X 3-1/2"	F1572	9/16" X 3"	F1585	11/16" X 4"
F1541	1/2" X 2-1/4"	F1573	9/16" X 3-1/4"	F1586	11/16" X 4-1/2"
F1542	1/2" X 2-1/2"	F1574	9/16" X 3-1/2"	F1587	11/16" X 5-1/2"
F1543	1/2" X 3"	F158	11/16" X 2-1/4"	F1588	11/16" X 7-1/4"

FLAT CASING/NO EASED EDGES

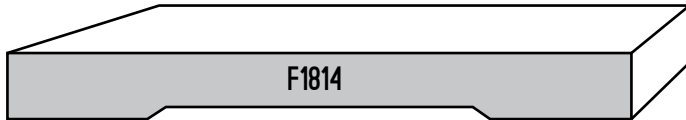

F1814 3/8" X 3 1/4"

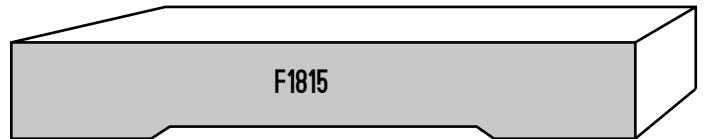

F1815 1/2" X 3 1/4"

BRICK MOULD/BACKBANDS

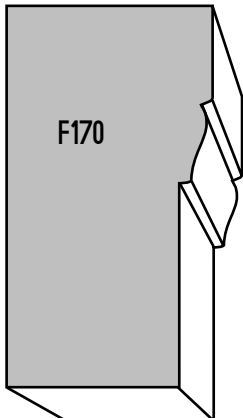

F170 - 1 1/16" X 2"

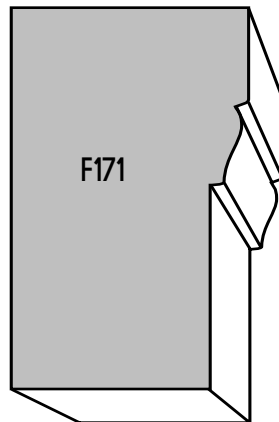

F171 - 1 1/4" X 2"

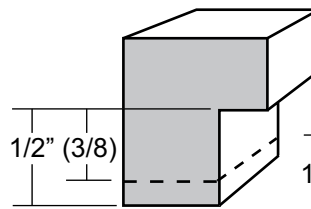

F1910 3/4" X 3/4"
F1915 3/4" X 7/8"

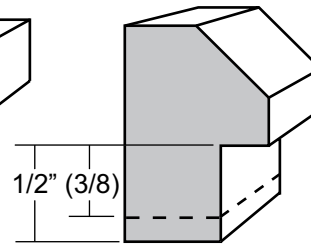

F1911 3/4" X 1"
F1916 3/4" X 1 1/8"

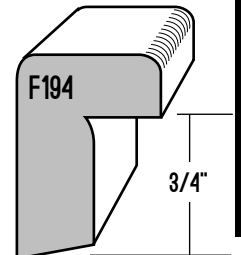

F194 - 3/4" X 1 1/16"

100 SERIES - FLAT CASING, BRICK MOULDS, BACKBANDS

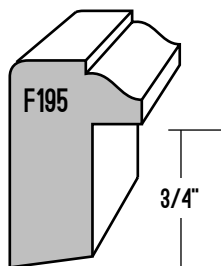

F195
11/16" X 1 1/16"

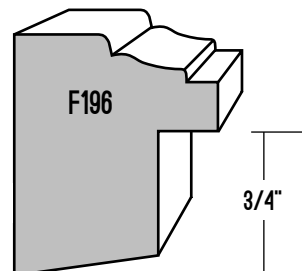

F196
1 1/4" X 1 1/16"

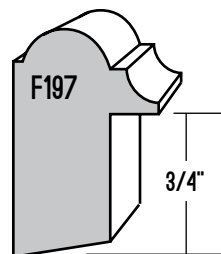

F197
3/4" X 1 3/16"



F1912
1" X 1 5/16"

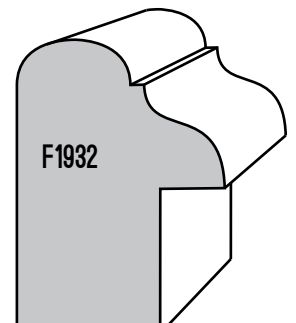

F1932
1 1/8" X 1 1/2"

BASEBOARDS

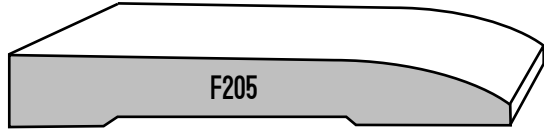

F205

F205 - 3/8" X 2 5/8"

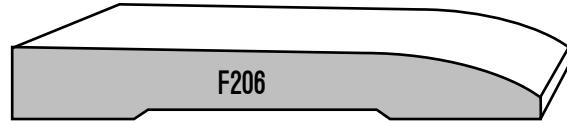

F206

F206 - 3/8" X 2 3/4"

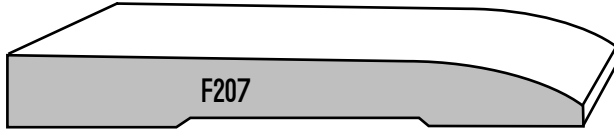

F207

F207 - 3/8" X 3"

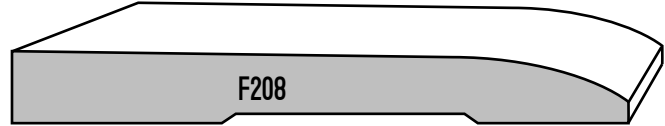

F208

F208 - 3/8" X 3 1/4"

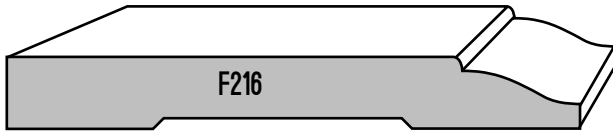

F216

F216 - 3/8" X 3"

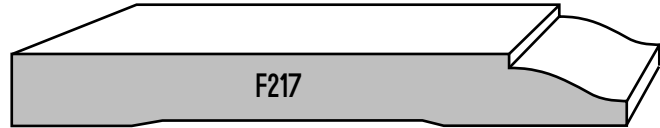

F217

F217 - 3/8" X 3 1/4"

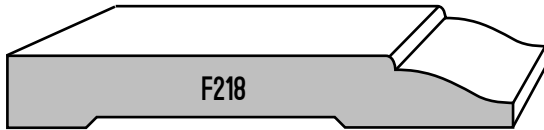

F218

F218 - 3/8" X 2 5/8"

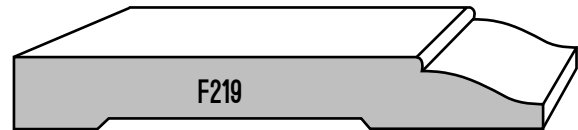

F219

F219 - 3/8" X 2 3/4"

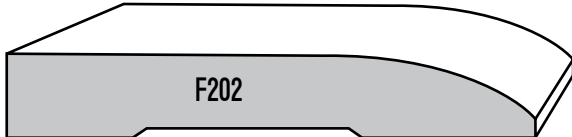

F202

F202 - 7/16" X 2 3/4"

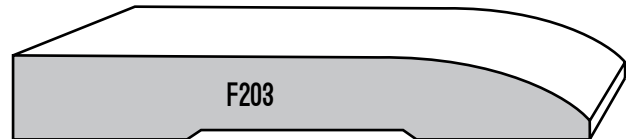

F203

F203 - 7/16" X 3"

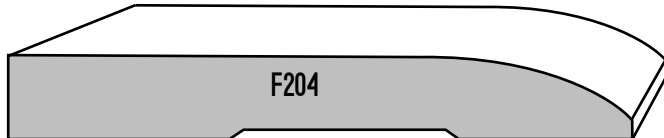

F204

F204 - 7/16" X 3 1/4"

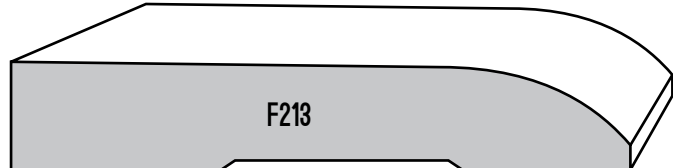

F213

F213 - 9/16" X 3 1/4"

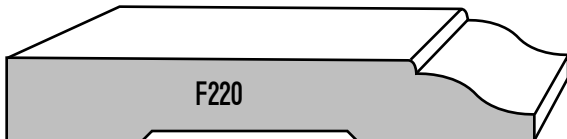

F220

F220 - 7/16" X 2 3/4"

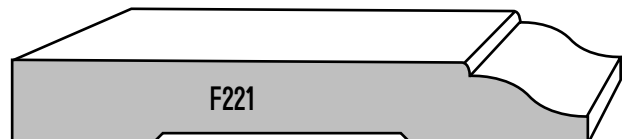

F221

F221 - 7/16" X 3"

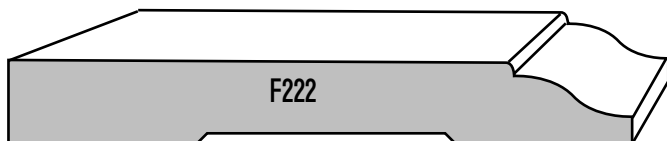

F222

F222 - 7/16" X 3 1/4"

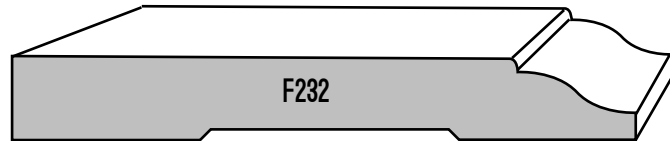

F232

F232 - 1/2" X 3 1/4"

BASEBOARDS

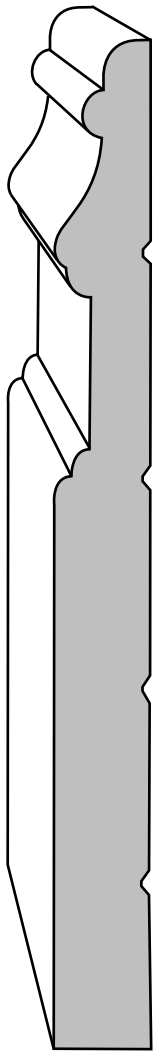

F2410 -
1/2" X 5 1/4"

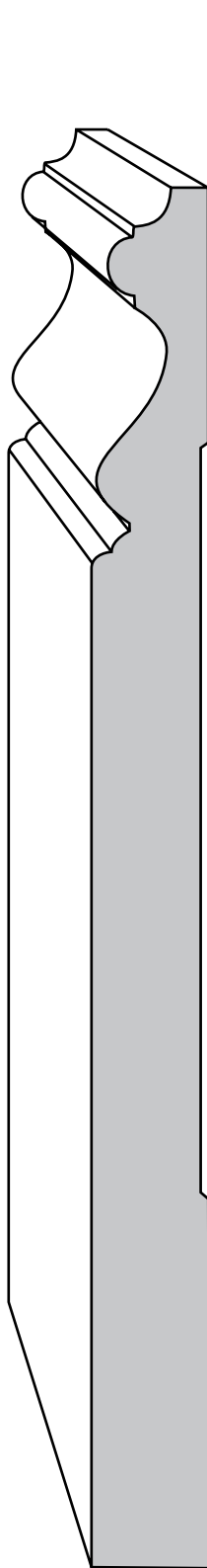

F2412 -
5/8" X 7 1/4"

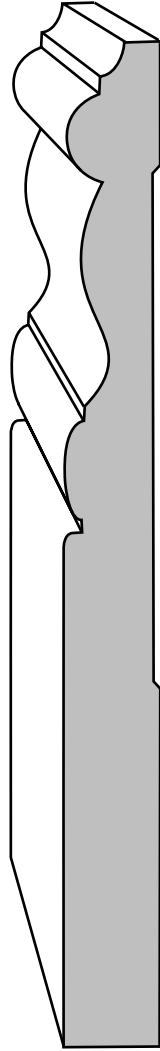

F2420 -
1/2" X 5 1/4"

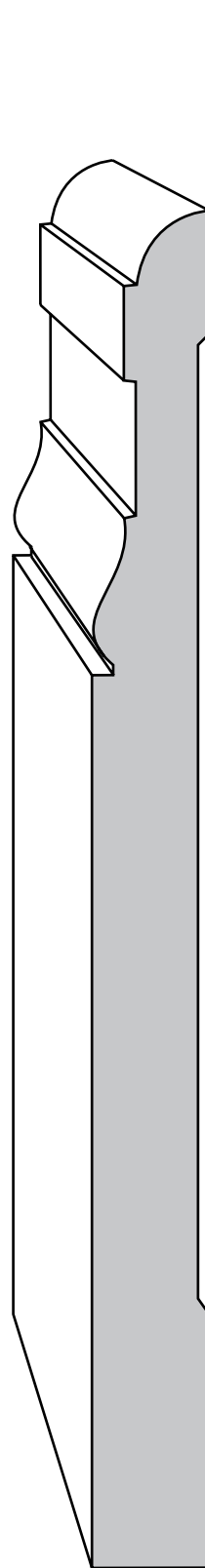

F2422 -
5/8" X 7 1/4"

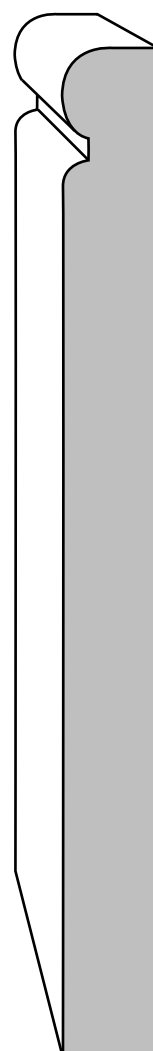

F2430 -
1/2" X 5 1/4"

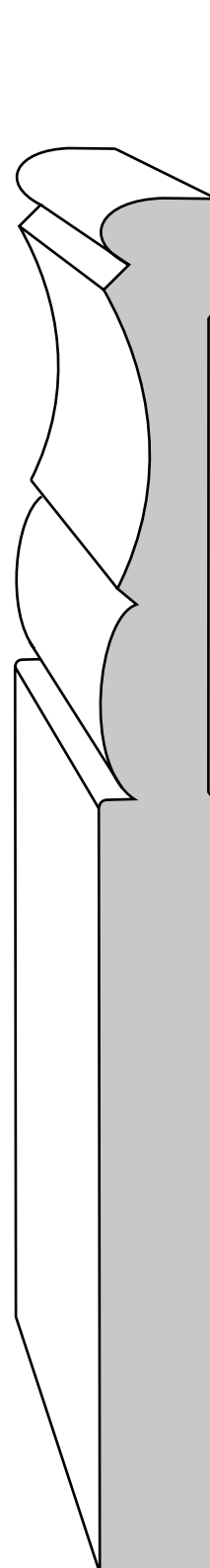

F2432 -
5/8" X 7 1/4"

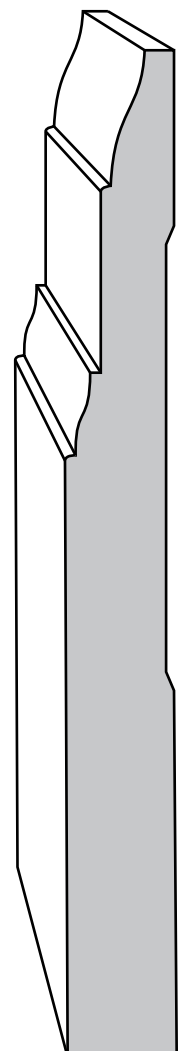

F2442 -
9/16" X 5 1/4"

200 SERIES - BASEBOARDS

BASEBOARDS

200 SERIES - BASEBOARDS

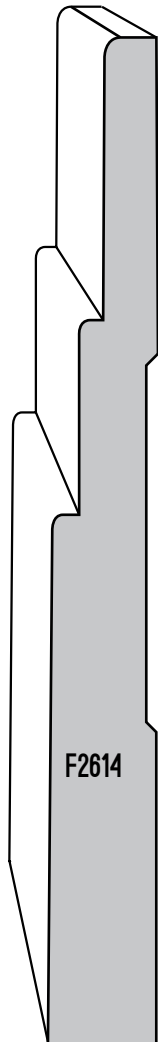

F2614

F2614 - 9/16" X 5 1/4"

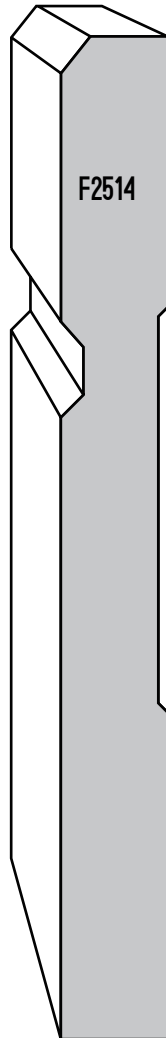

F2514

F2514 - 9/16" X 5 1/4"

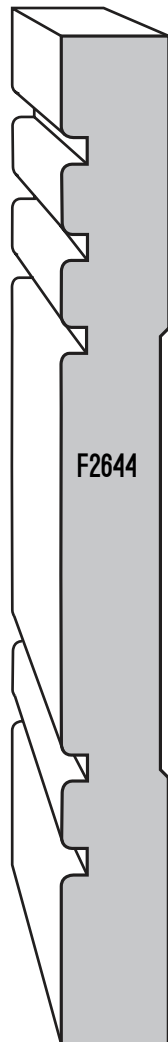

F2644

F2644 - 9/16" X 5 1/4"

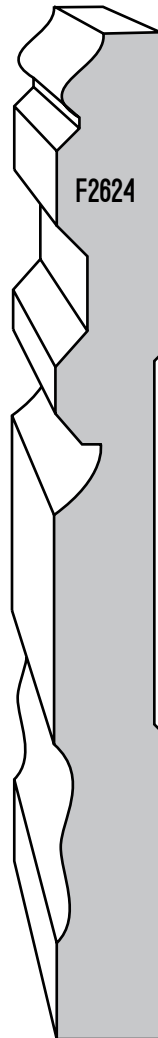

F2624

F2624 - 9/16" X 5 1/4"

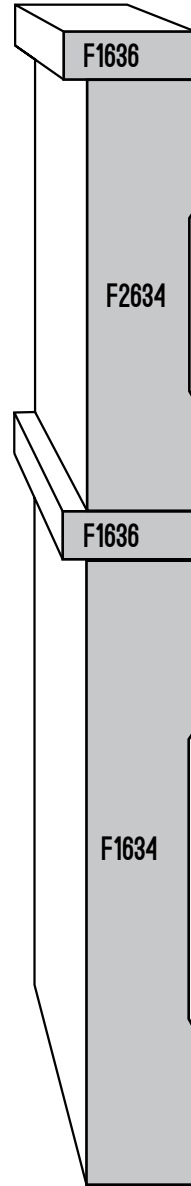

F1636

F2634

F1636

F1634

F1634 - 9/16" X 3 1/4"
F2634 - 9/16" X 2 1/4"
F1636 CASING CAP - 1/4" X 11/16"

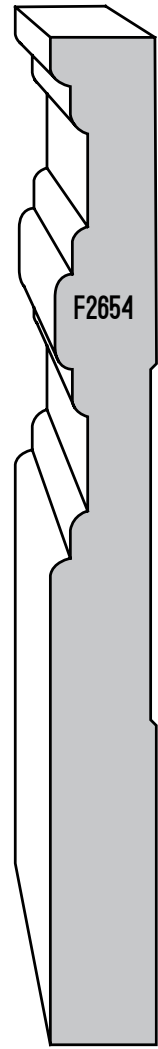

F2654

F1634 - 9/16" X 5 1/4"

BASEBOARDS

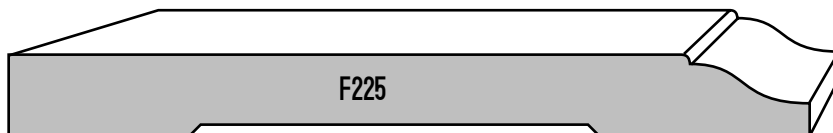

F225 - 7/16" X 4 1/4"

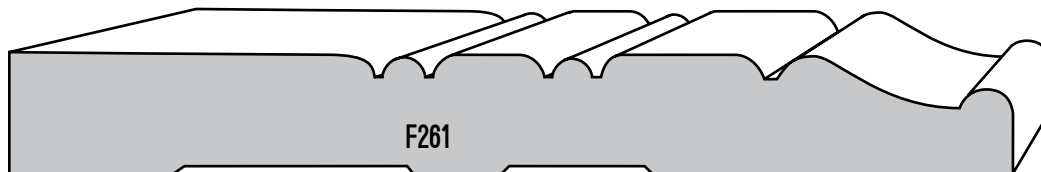

F261 - 5/8" X 5 1/4"

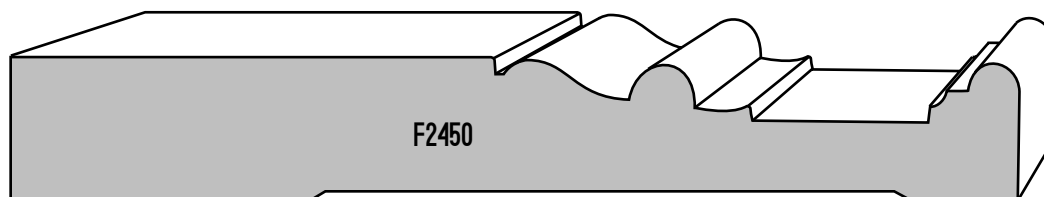

F2450 - 11/16" X 5 1/4"

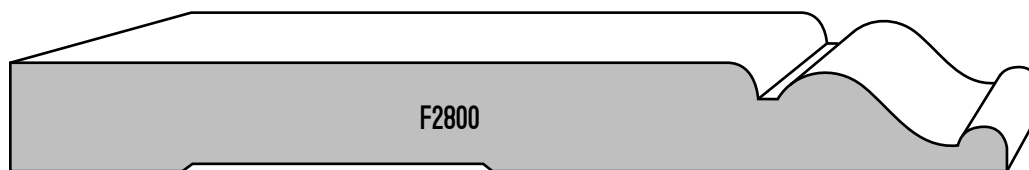

F2800 - 9/16" X 5 1/4"

FLAT BASE

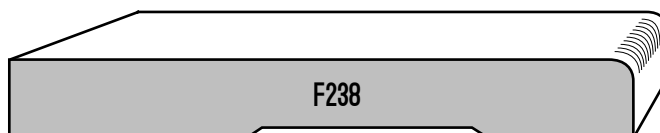

F238 - 7/16" X 3-1/4"

BASE - EASED 1 EDGE

PROFILE #	DIMENSIONS	PROFILE #	DIMENSIONS	PROFILE #	DIMENSIONS
F2350	3/8" X 2-3/4"	F238	7/16" X 3-1/4"	F2433	9/16" X 4-1/4"
F2351	3/8" X 3"	F2363	7/16" X 4-1/4"	F2434	9/16" X 5-1/4"
F2352	3/8" X 3-1/4"	F2364	7/16" X 5-1/4"	F2532	11/16" X 3-1/2"
F2353	3/8" X 4-1/4"	F2440	9/16" X 2-3/4"	F2533	11/16" X 4-1/4"
F2354	3/8" X 5-1/4"	F2431	9/16" X 3"	F2534	11/16" X 5-1/4"
F236	7/16" X 2-3/4"	F243	1/2" X 3-1/4"	F2535	11/16" X 7-1/4"
F237	7/16" X 3"	F2439	9/16" X 3-1/2"	F293	1/2" X 5 1/4"

BASE SHOE

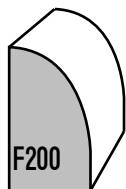

F200 - 7/16" X 3/4"



F726 - 1/2" X 3/4"

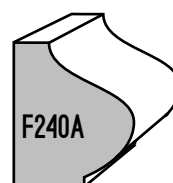

F240A - 5/8" X 3/4"

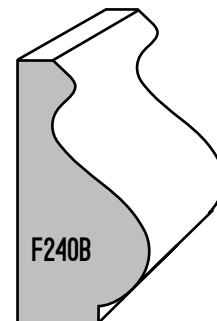

F240B - 11/16" X 1 3/8"

BASE CAPS

200 SERIES - BASEBOARDS, FLAT BASE, BASE SHOE, BASE CAPS

VENEERED BASE

CUTBACKS WILL BE SENT WITH ORDERS

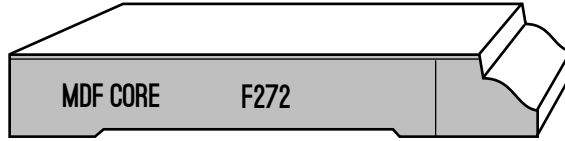

F272 - 7/16" X 2 3/4"
(SPECIAL ORDER - 1000 FOOT MINIMUM ORDER)

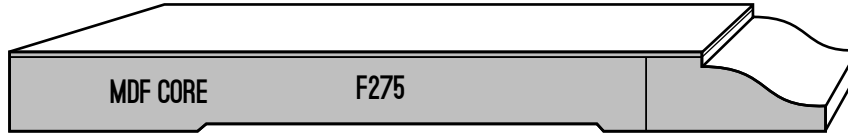

F275 - 7/16" X 4 1/4"

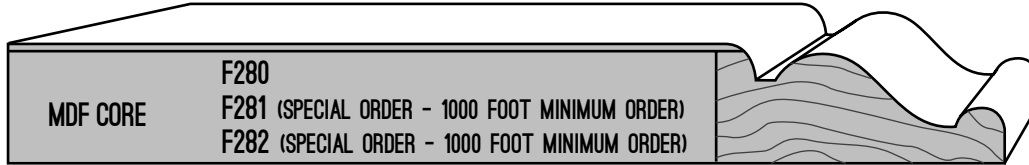

F280 - 5/8" X 5 1/4"
F281 - 5/8" X 7 1/4"
F282 - 5/8" X 9 1/4"

NOTE: CAPS ON VENEERED BASES ARE FINGERJOINTED SOLID MATERIAL.

BASE CORNER BLOCKS

OUTSIDE CORNER

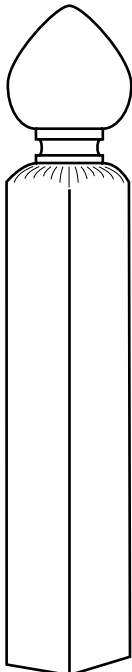

F286A
F289A
F286B
F289B

F286A - 1 1/2" X 1 1/2" X 8"
F289A - 1 1/4" X 1 1/4" X 8"
F286B - 1 1/2" X 1 1/2" X 12"
F289B - 1 1/4" X 1 1/4" X 12"

INSIDE CORNER

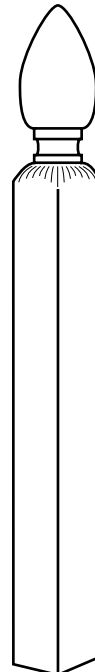

F285A
F288A
F285B
F288B

F285A - 3/4" X 3/4" X 8"
F288A - 5/8" X 5/8" X 8"
F285B - 3/4" X 3/4" X 12"
F288B - 5/8" X 5/8" X 12"

CORNER/PLINTH BLOCKS

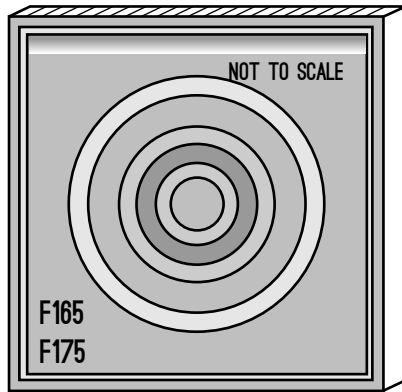

F165 - 1 1/16" X 3 1/2" X 3 1/2"(W/ROSETTE)
F175 - 1" X 2 1/2" X 2 1/2"(W/ROSETTE)



SECTION
NOT TO SCALE



F166 - 1 1/16" X 3 1/2" X 8"(W/ROSETTE)
F176 - 1" X 2 1/2" X 6"(W/ROSETTE)

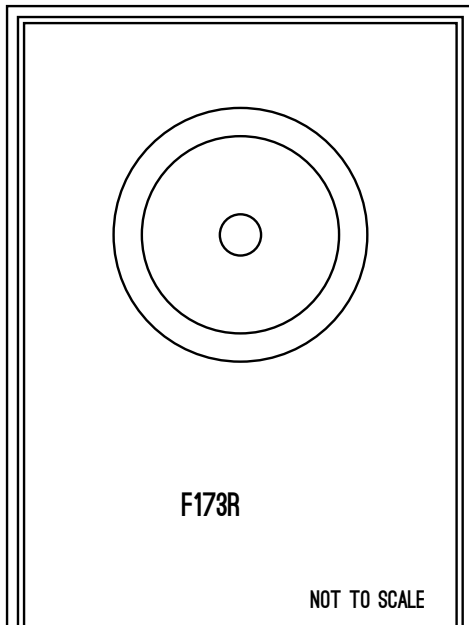

F172 - 1 1/16" X 6" X 6"(W/ROSETTE)
F173 - 1 1/16" X 6" X 8"
F173R - 1 1/16" X 6" X 8"(W/ROSETTE)

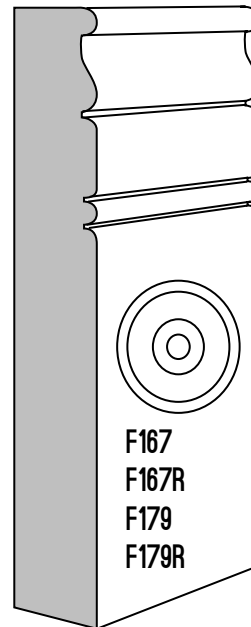

F167 - 1 1/16" X 3 1/2" X 8"
F167R - 1 1/16" X 3 1/2" X 8"(W/ROSETTE)
F179 - 1 1/16" X 6" X 8"
F179R - 1 1/16" X 6" X 8"(W/ROSETTE)

DOOR STOP

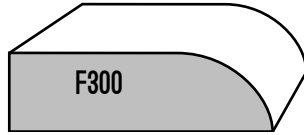

F300 - 7/16" X 1 3/8"

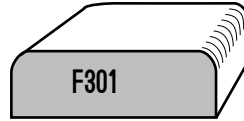

F301 - 3/8" X 1 1/16"

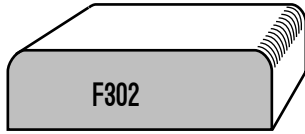

F302 - 7/16" X 1 3/8"

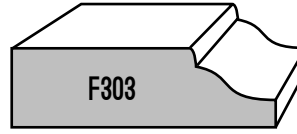

F303 - 7/16" X 1 3/8"

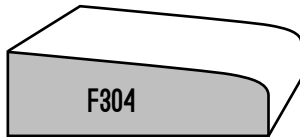

F304 - 7/16" X 1 3/8"

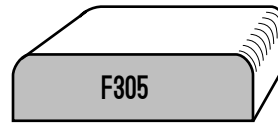

F305 - 3/8" X 1 1/4"

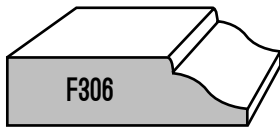

F306 - 3/8" X 1 1/4"

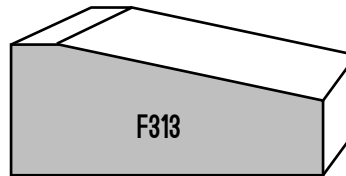

F313 - 11/16" X 1 5/8"



F311 - 7/16" X 1 5/8"

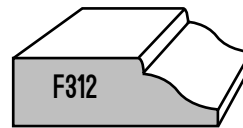

F312 - 3/8" X 1 1/16"

ASTRAGALS

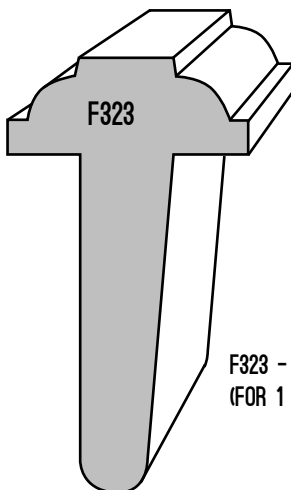

F323 - 1 1/4" X 2 3/8"
(FOR 1 3/4" DOORS)

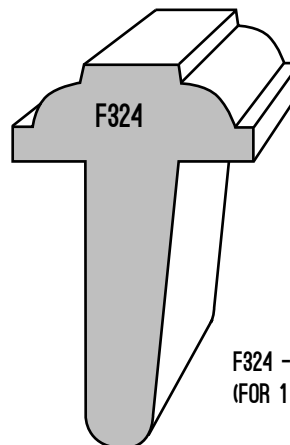

F324 - 1 1/4" X 2 1/16"
(FOR 1 3/8" DOORS)

VENEERED DOOR JAMBS

- F330A - 11/16" X 4 9/16"
- F330E - 11/16" X 4 13/16"
- F330J - 11/16" X 5 1/4"
- F330P - 11/16" X 6 9/16"

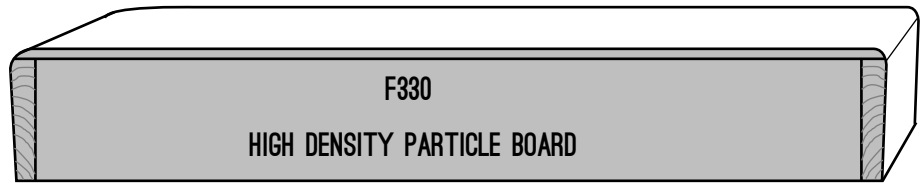

(SOME F330 WILL HAVE SOLID EDGE STRIPS UNDER WRAPPED VENEER)

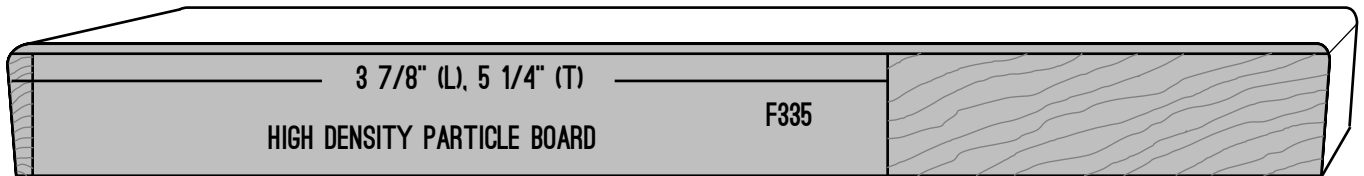

- F335T - 11/16" X 7 1/2" - TRIMMABLE JAMB
- F335L - 11/16" X 5 1/2" - TRIMMABLE JAMB

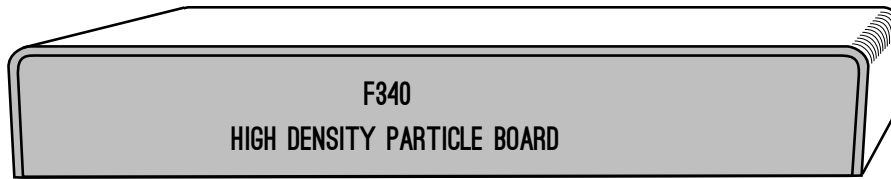

- F340A - 11/16" X 4 9/16"
- F340E - 11/16" X 4 13/16"
- F340J - 11/16" X 5 1/4"
- F341A - 5/8" X 4 9/16" (COMMERCIAL GRADE PARTICLE BOARD)

- F346A - 11/16" X 4 9/16"
- F346E - 11/16" X 4 13/16"
- F346J - 11/16" X 5 1/4"

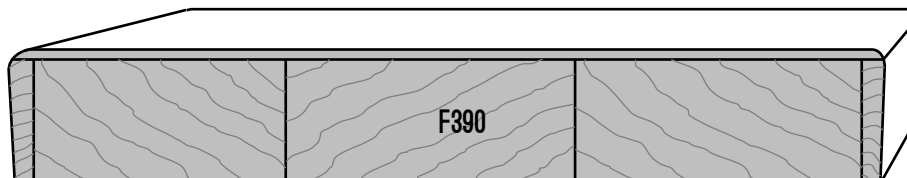
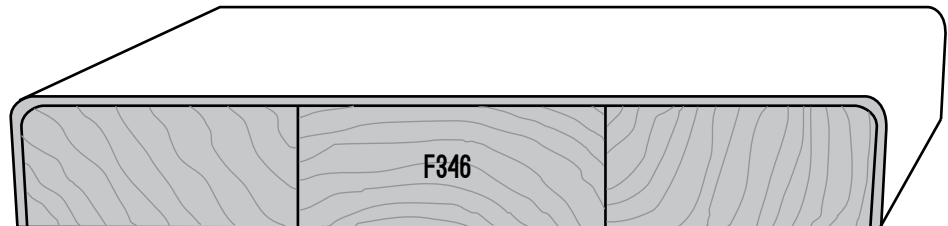

- F390A - 11/16" X 4 9/16"
- F390E - 11/16" X 4 13/16"
- F390J - 11/16" X 5 1/4"

NOTE: Veneered door jambs are not designed to be used as window extension jambs.

SOLID FLAT DOOR JAMB

- F381A - 11/16" X 4 9/16"
- F381E - 11/16" X 4 13/16"
- F381J - 11/16" X 5 1/4"

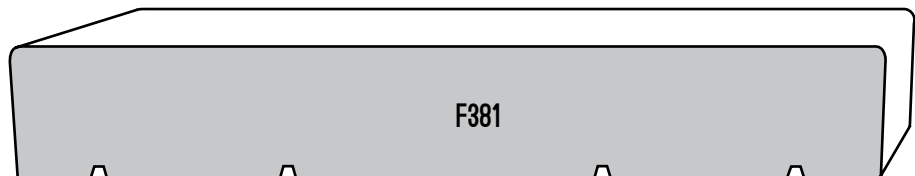

20 MINUTE WHI FRAMES

20 MIN. SOLID FLAT JAMB

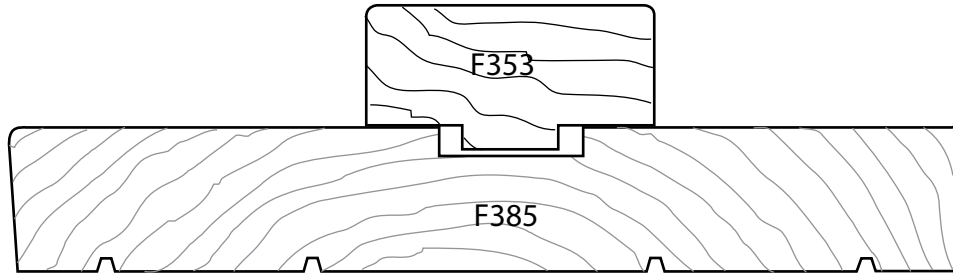

F385E 3/4" X 4 13/16"
F385J 3/4" X 5 1/4"

20 MIN. SOLID RABBETED JAMB

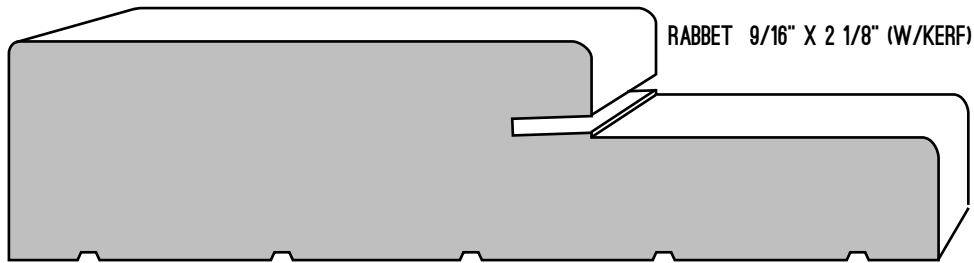

F355E 1 1/4" X 4 13/16"
F355K 1 1/4" X 5 3/8"

20 MIN. VENEERED RABBETED JAMB

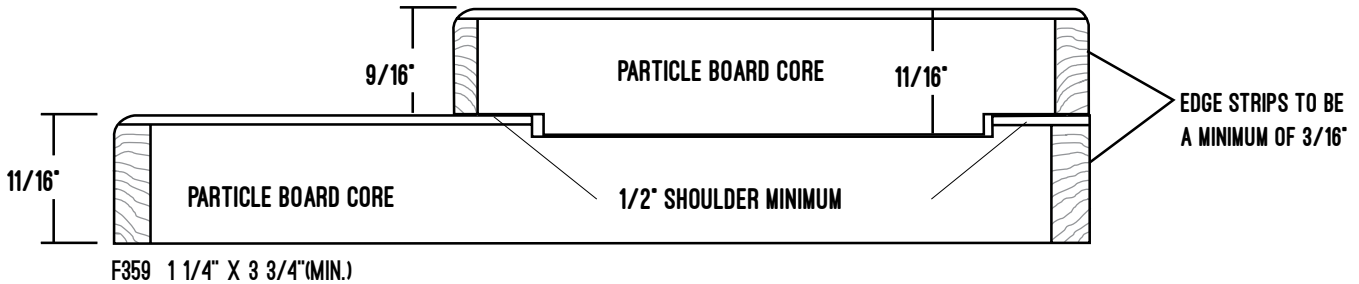

F359 1 1/4" X 3 3/4"(MIN.)

SOLID RABBETED JAMB - UNRATED

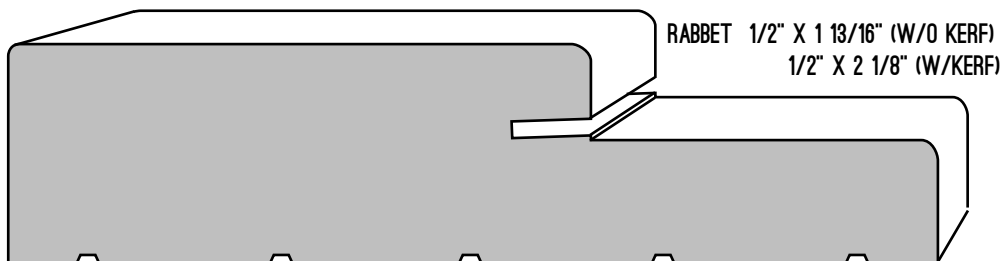

F365 A 1 3/16" X 4 9/16"
F365E 1 3/16" X 4 13/16"
F365K 1 3/16" X 5 3/8"

NOTE: Veneered door jambs are not designed to be used as window extension jambs.

20 MINUTE WHI FRAMES

VENEERED DOOR FRAME

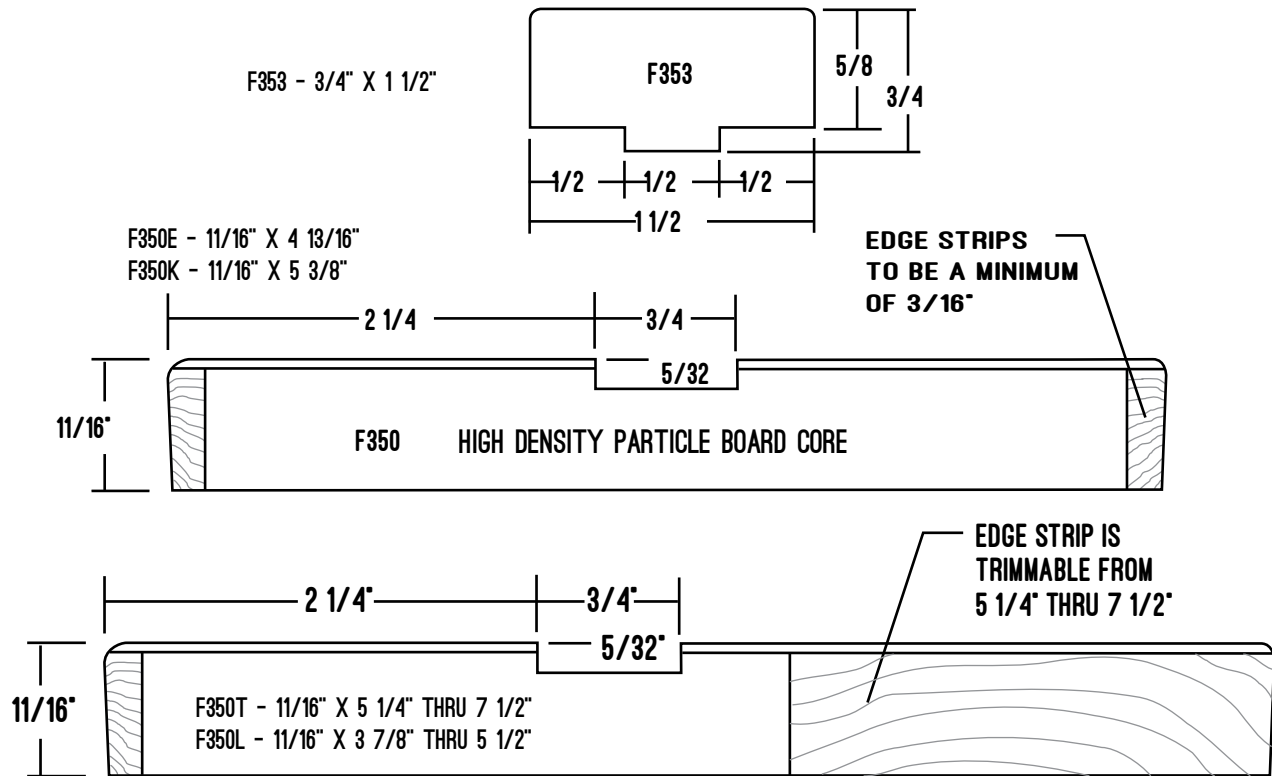

Door Frames are sold by sets which include jamb sides, head and respective T-stops. Window Frames are sold by individual components on a lineal foot basis. Pieces are stamped with Warnock Hersey certification and must be machined by a WHI certified door hanger to receive a 20 minute label. Installation must be done in accordance with manufacturer's instructions. A pressure-sensitive smoke gasket (category "H") must be attached to the frame as part of the rated assembly, which gives the frame a "S" label rating. A positive pressure certification may be achieved with the addition of an edge sealing gasket (category "G").

NOTE: A positive pressure frame may be used with a category "B" door for a positive pressure opening.

VENEERED SIDELIGHT/BORROWED LIGHT WINDOW FRAME

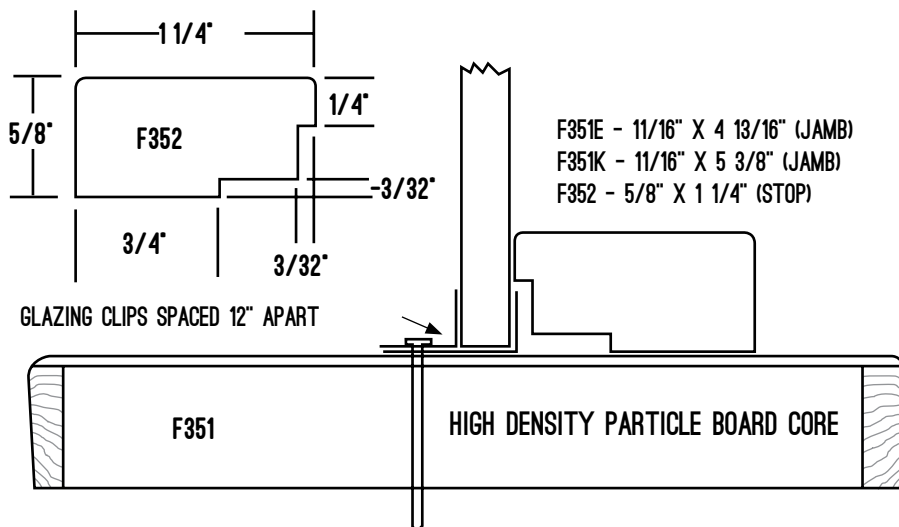

RATED VENEERED FRAMES ARE AVAILABLE IN STANDARD SIZES ONLY

NOTE: Veneered door jambs are not designed to be used as window extension jambs.

300 SERIES - VENEERED & SOLID DOOR FRAMES, SIDELIGHT FRAME

45/60/90 MINUTE WHI FRAMES

45, 60 and 90 minute jambs are manufactured by Ferche using one of two core materials. Laminated Core will be used except when door openings exceed Laminated Core's maximum opening size of 6/0 x 8/0 in 45 minute and 60 minute ratings and maximum size of 4/0 x 8/0 in 90 minute openings. Jambs are 3/4" (+/- 1/16) thick. Georgia Pacific's "Firestop®" composite mineral core substrate will be used for larger openings, up to 8'0" x 9'0". Frame is 1" thick. Both frame types are suitable for positive pressure certification. "S" label certification is achieved with the proper Category "H", or smoke/draft control gasket. These jambs are certified by Warnock Hersey (Intertek Testing) and must be machined by a company registered with them. Installation must be done in accordance with manufacturer's instructions.

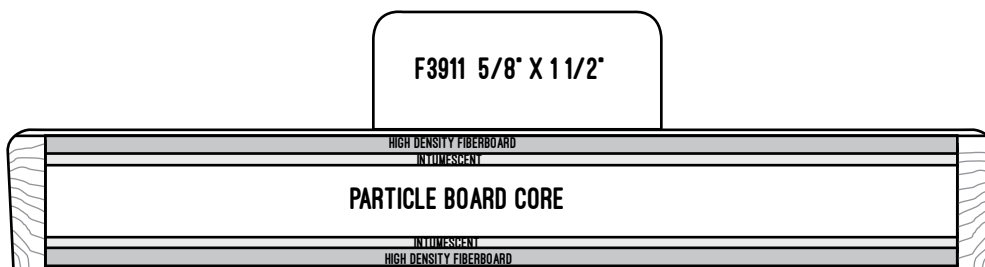

F343 45 MINUTE FIRE RATED LAMINATED DOOR FRAME

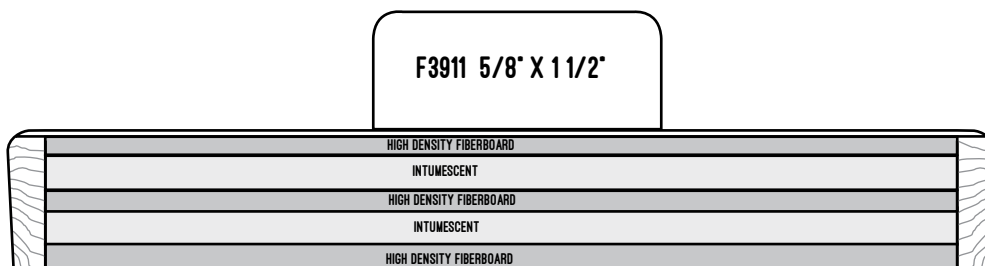

F344 60 MINUTE FIRE RATED DOOR FRAME

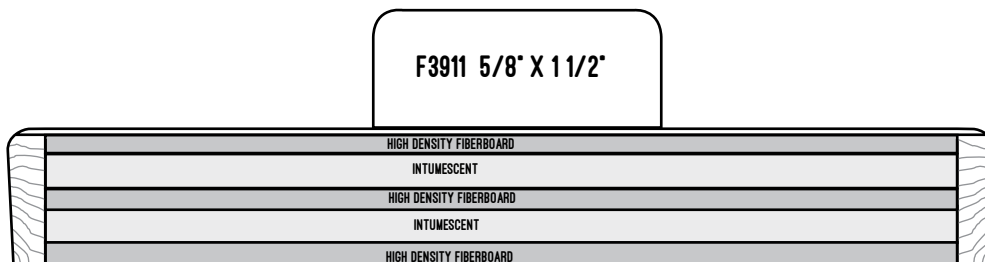

F345 90 MINUTE FIRE RATED LAMINATED DOOR FRAME

NOTE: Veneered door jambs are not designed to be used as window extension jambs.

LAMINATED CORE 45/60/90 MINUTE RATED SINGLE RABBETTED FRAMES

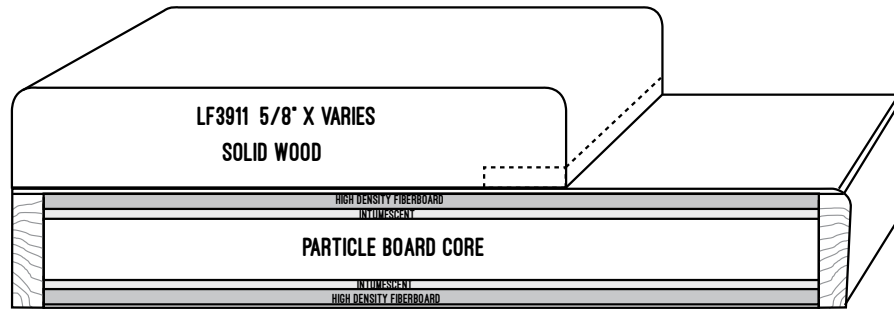

F347 45 MINUTE FIRE RATED LAMINATED DOOR FRAME

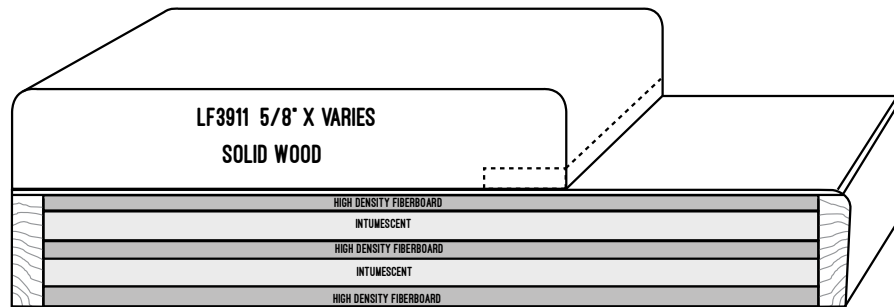

F348 60 MINUTE FIRE RATED DOOR FRAME

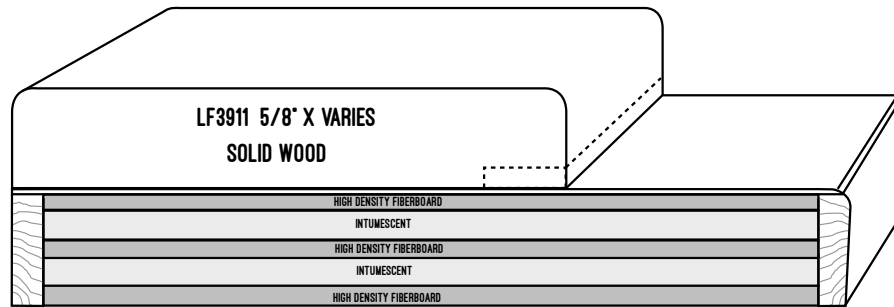

F349 90 MINUTE FIRE RATED DOOR FRAME

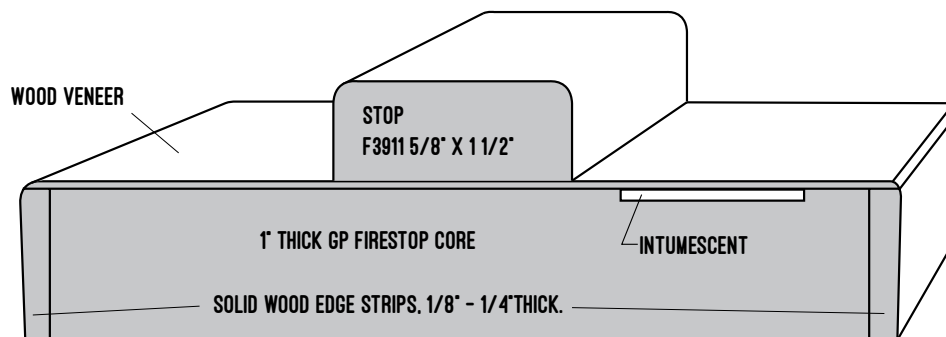

- F356 45 MINUTE POSITIVE PRESSURE FRAME**
- F357 60 MINUTE POSITIVE PRESSURE FRAME**
- F358 90 MINUTE POSITIVE PRESSURE FRAME**

NOTE: Veneered door jambs are not designed to be used as window extension jambs.

RABBETED JAMB SPECIFICATIONS

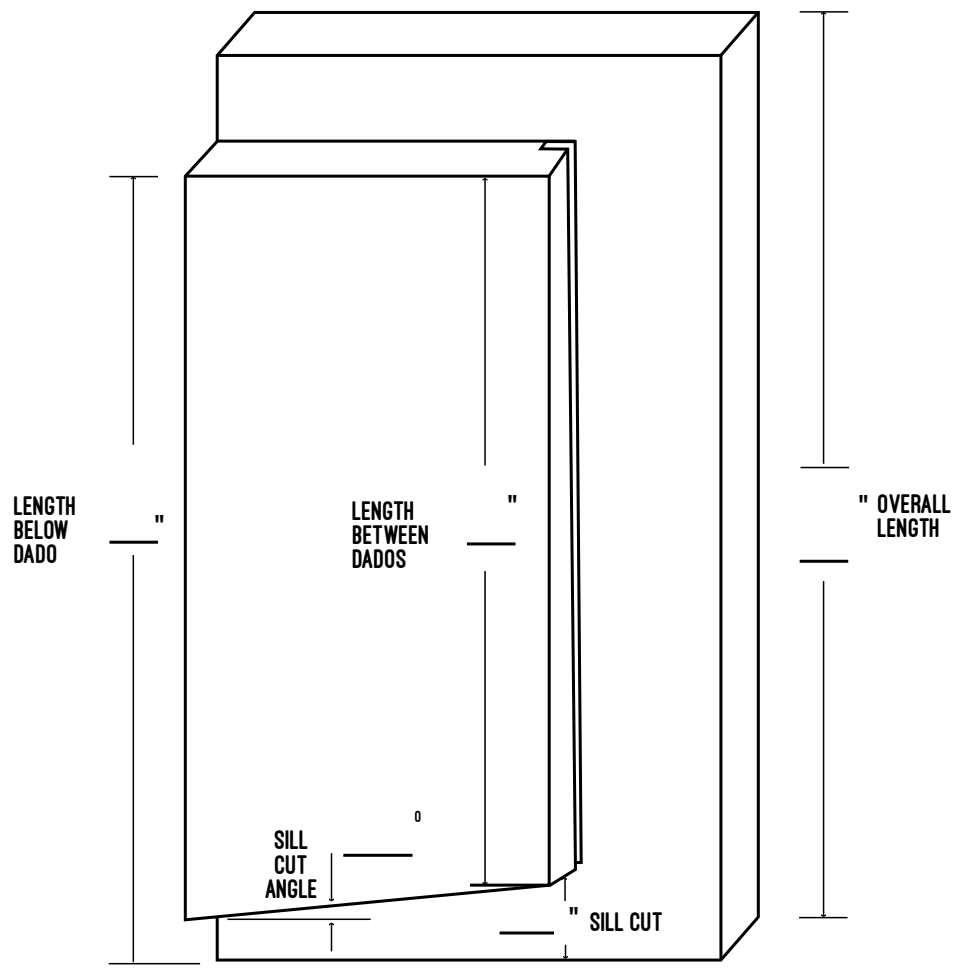
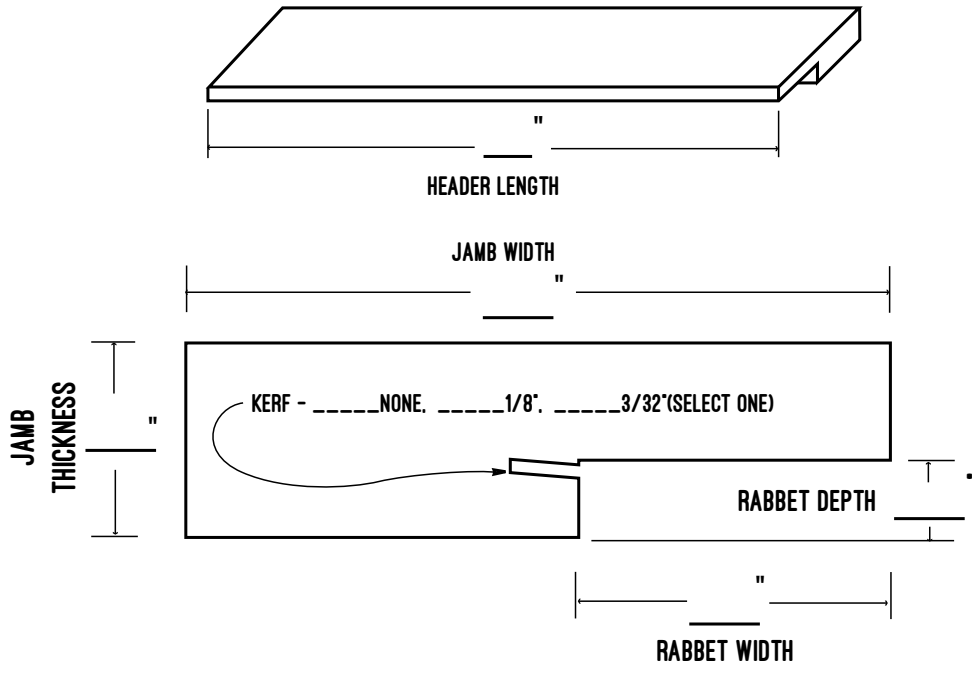

300 SERIES - RABBETED JAMB SPECIFICATIONS SHEET

SOLID S4S BOARDS

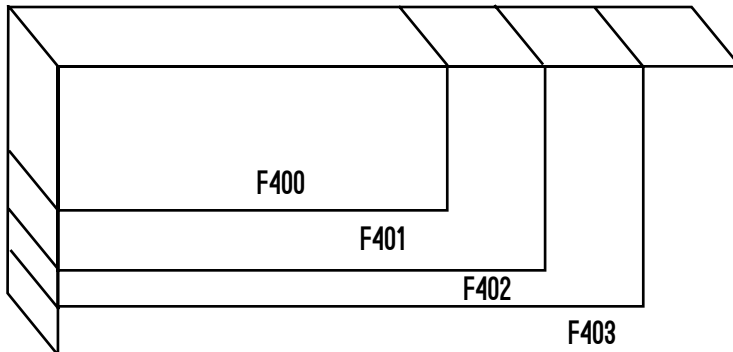

F400 FOR 3/4" THICK
F401 FOR 1 1/16" THICK
F402 FOR 1 1/4" THICK
F403 FOR 1 1/2" THICK

WIDTHS UP TO 11 1/4"

VENEERED BOARDS

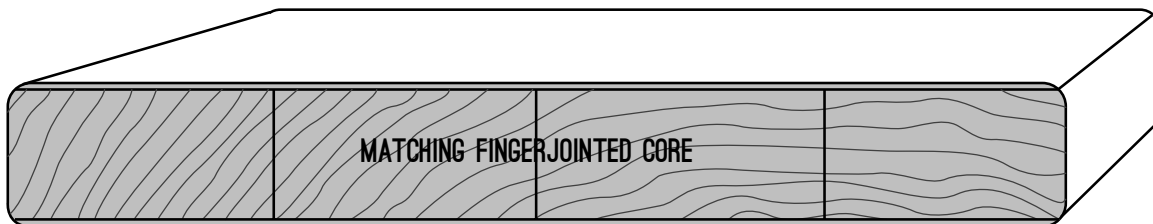

F410
3/4" X 5 1/2"
(SPECIAL ORDER)

F412
3/4" X 7 1/4"
(SPECIAL ORDER)

F414
3/4" X 9 1/4"

F416
3/4" X 11 1/4"

NOTE: F410, F412, F414 & F416 are available with veneer on just 1 side upon request. Please specify when ordering.

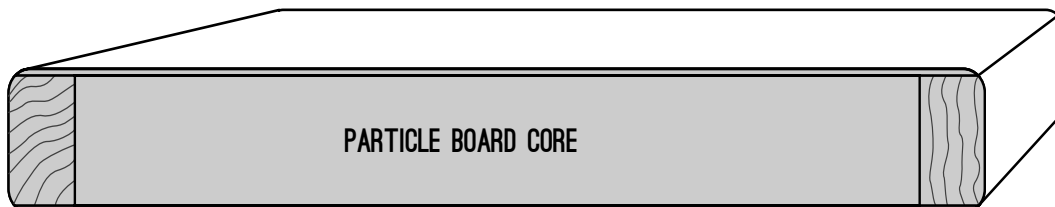

F420
3/4" X 5 1/2"
(SPECIAL ORDER)

F421
3/4" X 7 1/4"
(SPECIAL ORDER)

F422
3/4" X 9 1/4"
(SPECIAL ORDER)

F424
3/4" X 11 1/4"

NOTE: The veneered boards on this page are not designed to be used as window extension jambs.

CABINET PARTS/BAR RAIL

BACKSPLASH

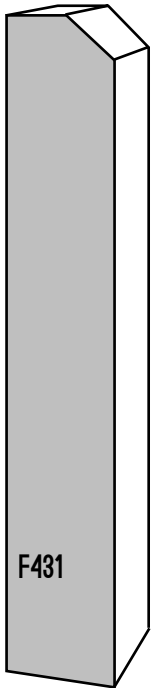

F431

F431 - 9/16" X 3 1/2"

EDGE BANDS

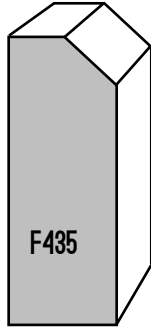

F435

F435 - 9/16" X 1 1/2"

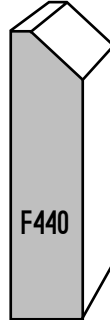

F440

F440 - 3/8" X 1 1/2"

LIP MOULDING

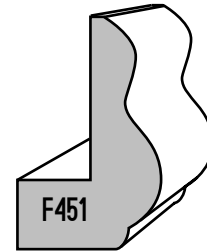

F451

F451 - 3/4" X 1 1/4"

BAR RAIL

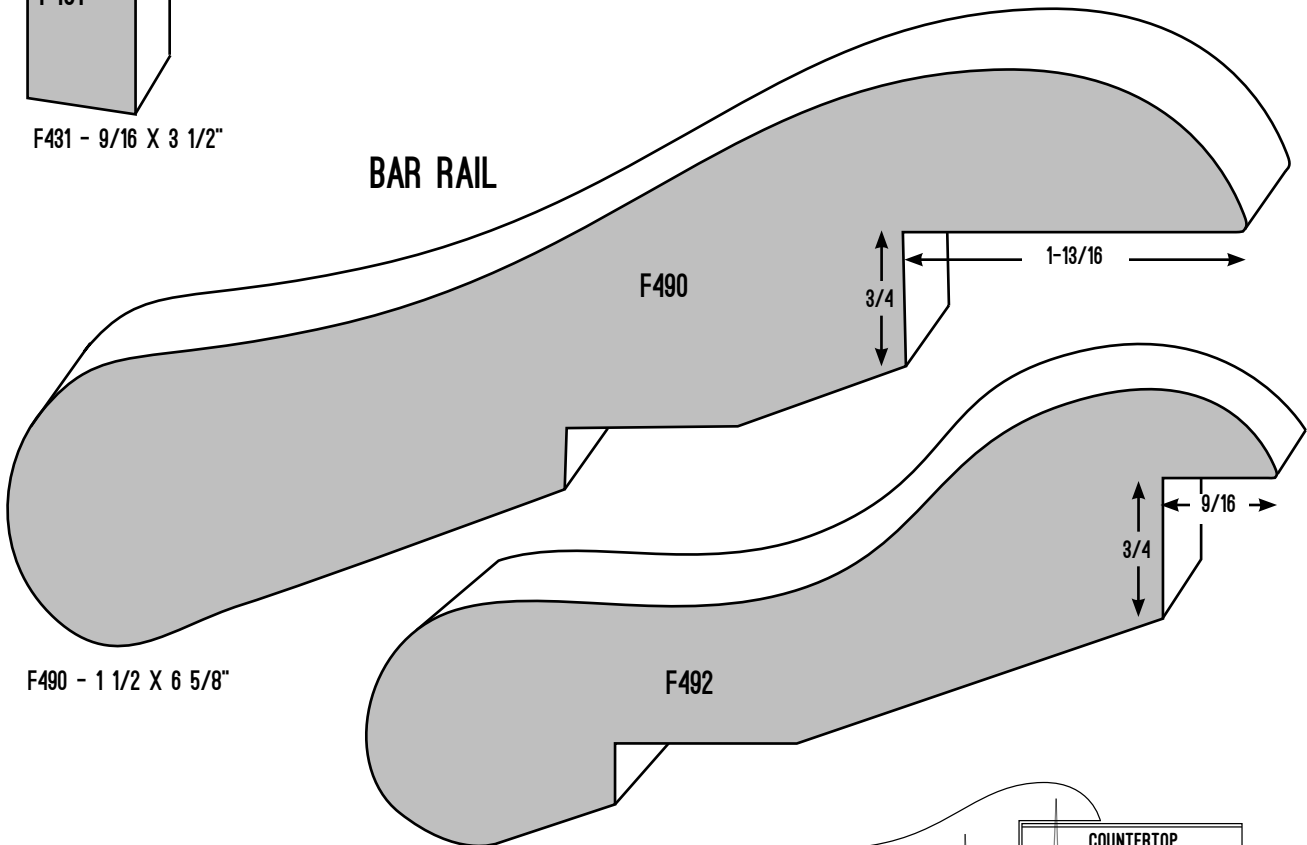

F490

1-13/16

3/4

F490 - 1 1/2" X 6 5/8"

F492

3/4

9/16

F492 - 1 1/4" X 5"

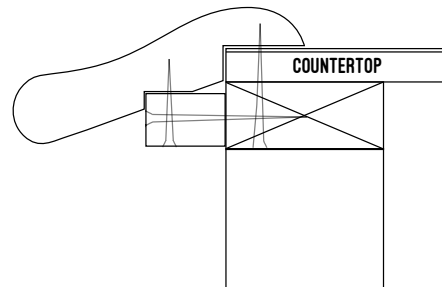

EZ BEAM CEILING BEAM SYSTEM

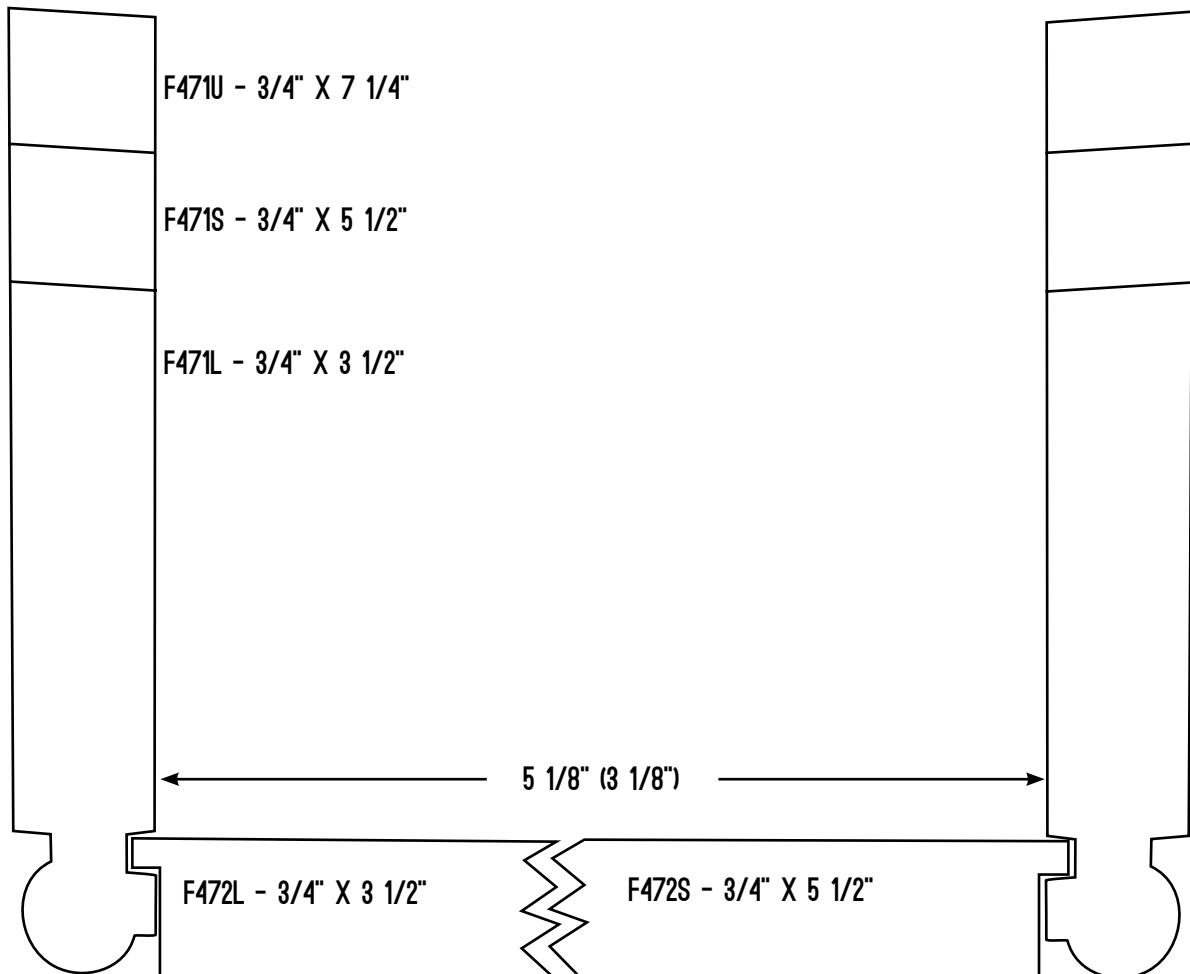
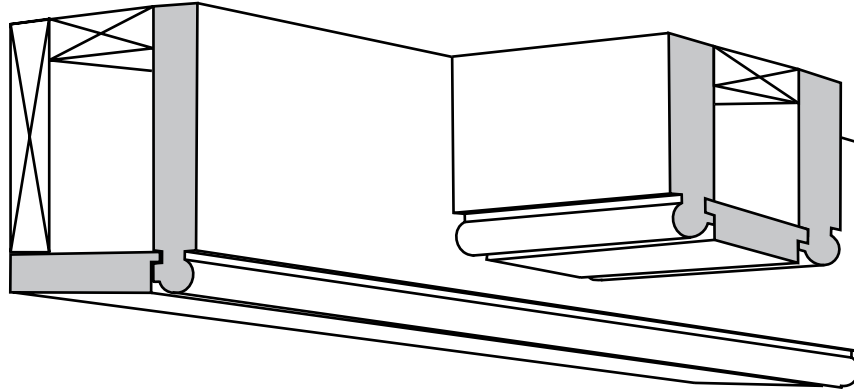

400 SERIES - EZ-BEAM CEILING BEAM SYSTEM

MULL CENTER

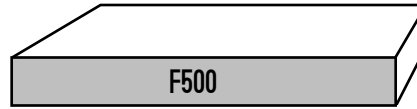

- | | |
|-----------------------|-----------------------|
| F500A - 1/4" X 1 1/4" | F500I - 1/4" X 3 1/2" |
| F500B - 1/4" X 1 1/2" | F500J - 1/4" X 4" |
| F500C - 1/4" X 1 3/4" | F500K - 1/4" X 4 1/2" |
| F500D - 1/4" X 2" | F500L - 1/4" X 5" |
| F500F - 1/4" X 2 1/2" | F500N - 1/4" X 6" |
| F500H - 1/4" X 3" | |

SCREEN MOULD/STOOL

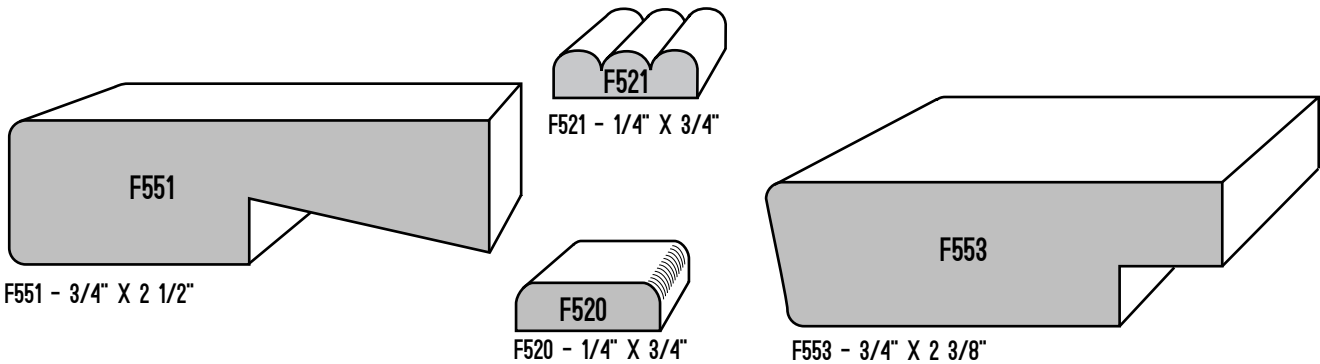

PICTURE FRAME/HANGER

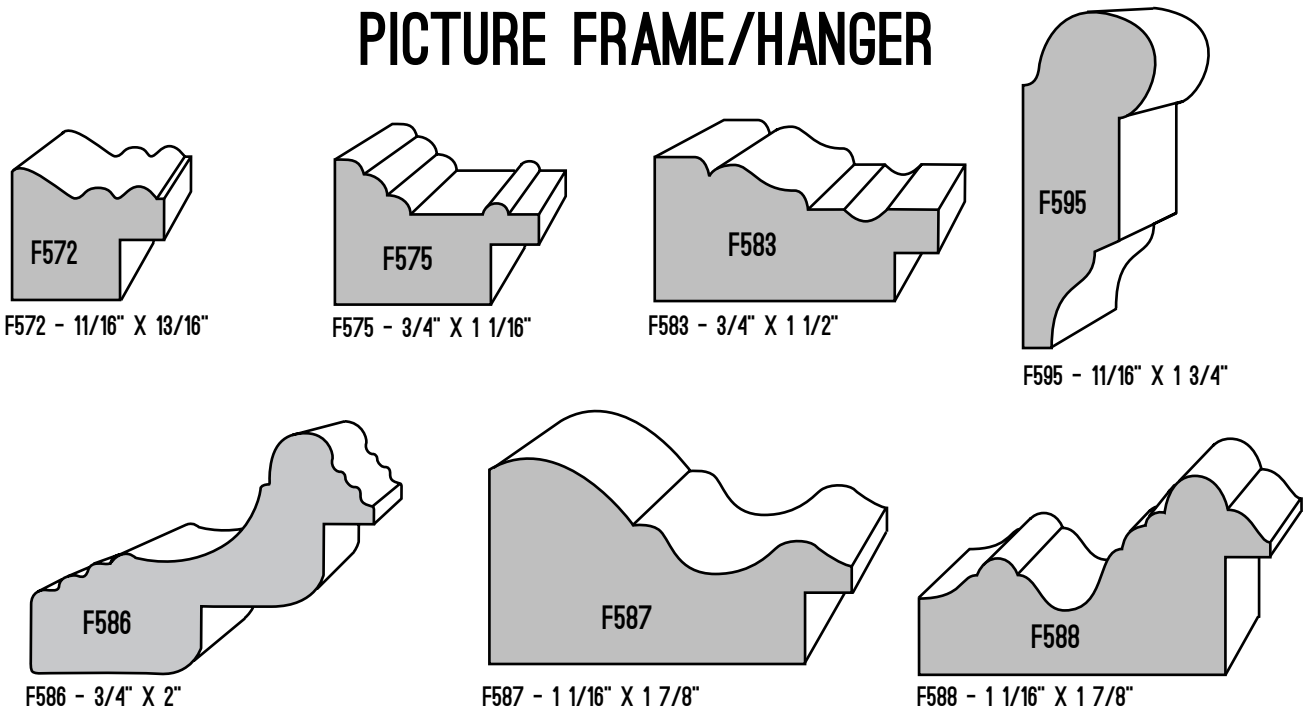

COVES



F600 - 1/2" X 1/2"

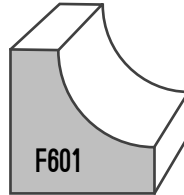

F601 - 3/4" X 3/4"

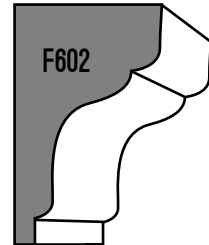

F602 - 3/4" X 1 1/4"

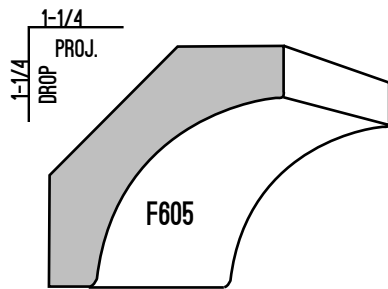

F605 - 9/16" X 1 3/4"

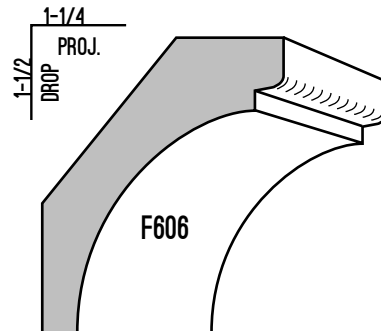

F606 - 9/16" X 2"

BED MOULDS

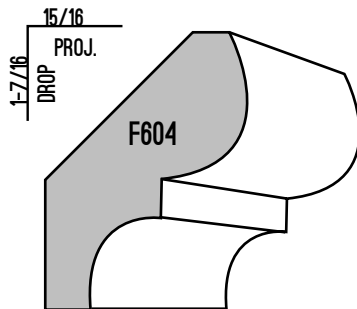

F604 - 9/16" X 1 3/4"

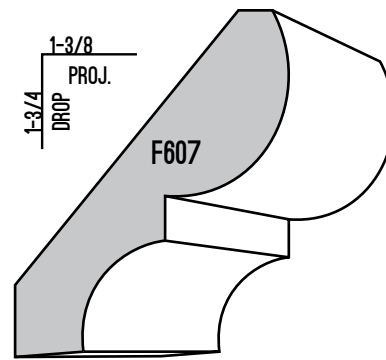

F607 - 9/16" X 2 1/4"

600 SERIES - COVES, BED MOULDS

CROWNS

600 SERIES - CROWN MOULDING

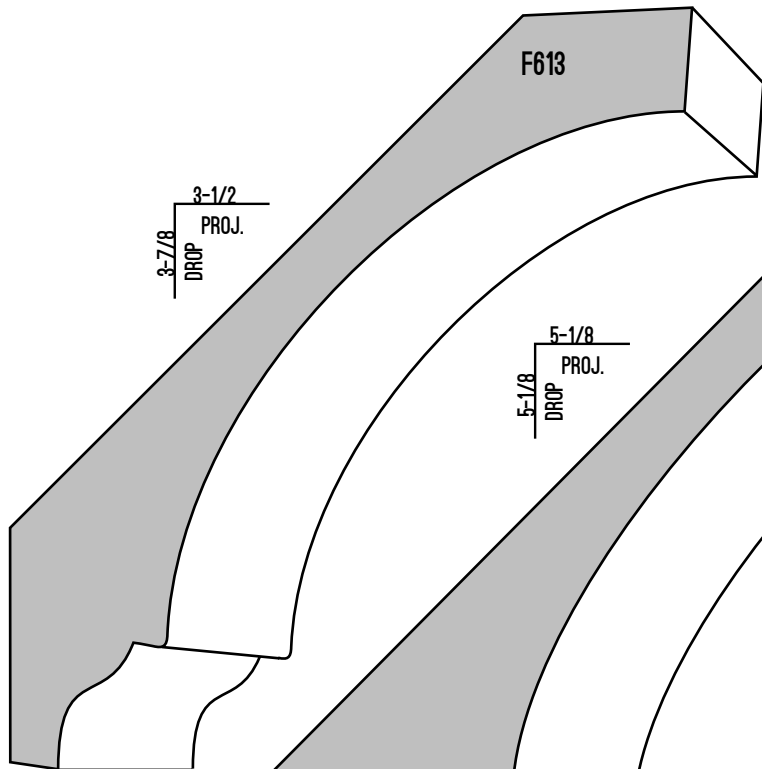

F613 -
1 1/16" X 5 3/8"

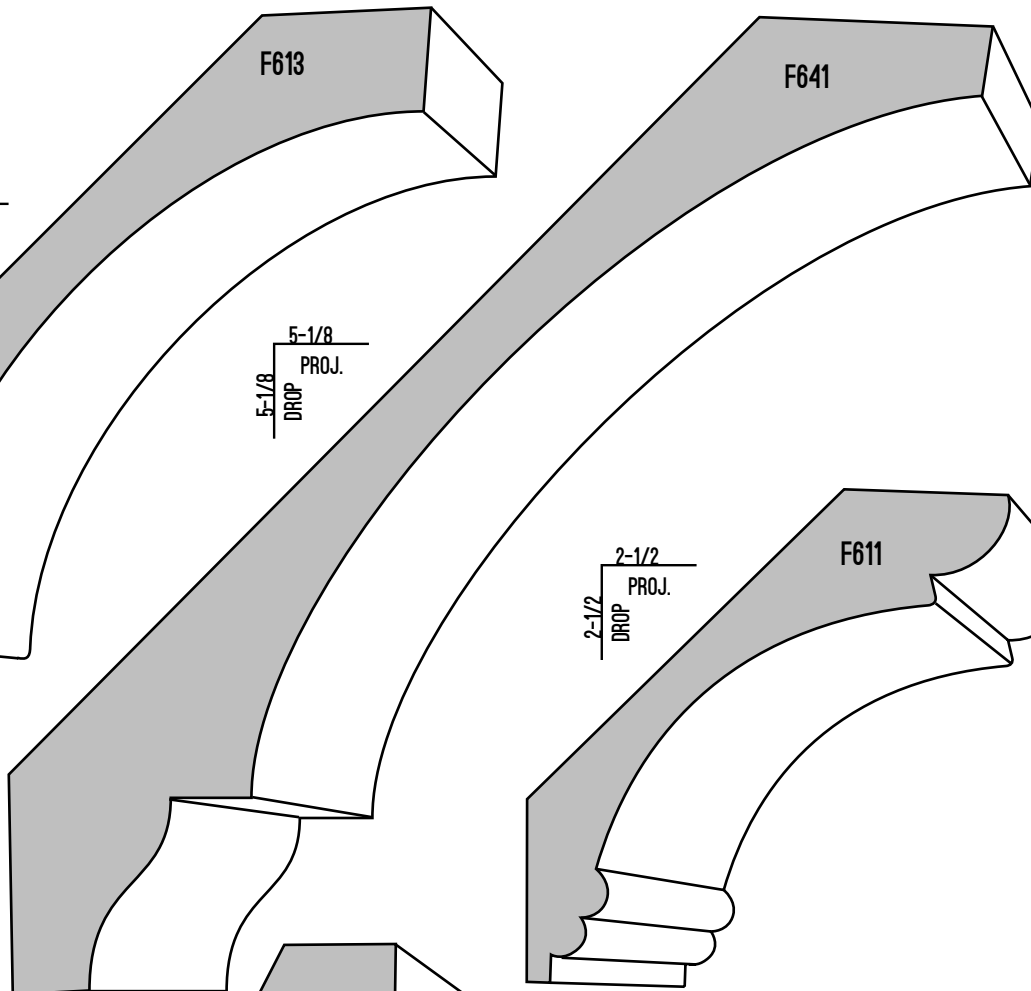

F641 -
1 1/16" X 7 1/4"

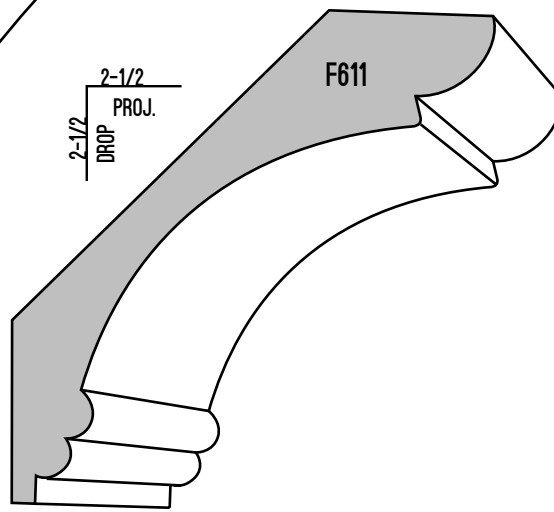

F611 - 3/4" X 3 5/8"

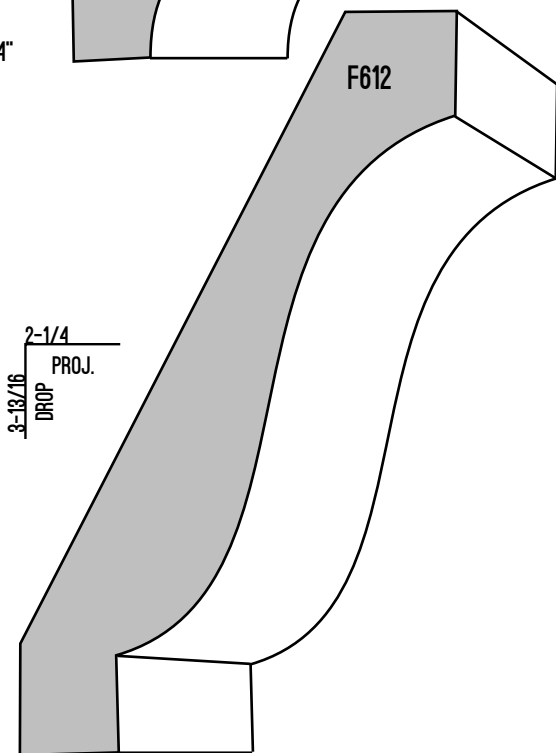

F612 - 3/4" X 4 9/16"

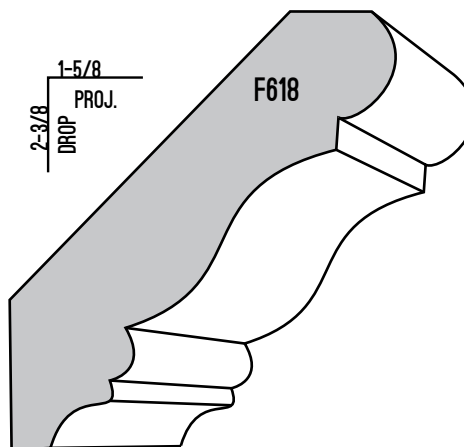

F618 - 3/4" X 3"

CROWNS

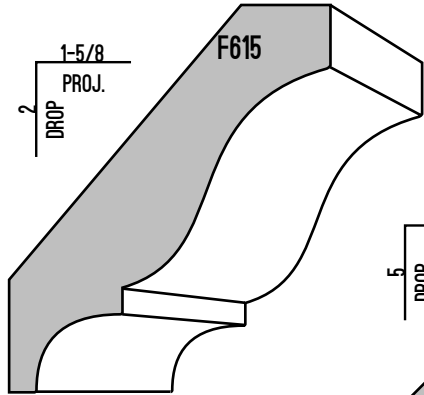

F615 - 9/16" X 2 5/8"

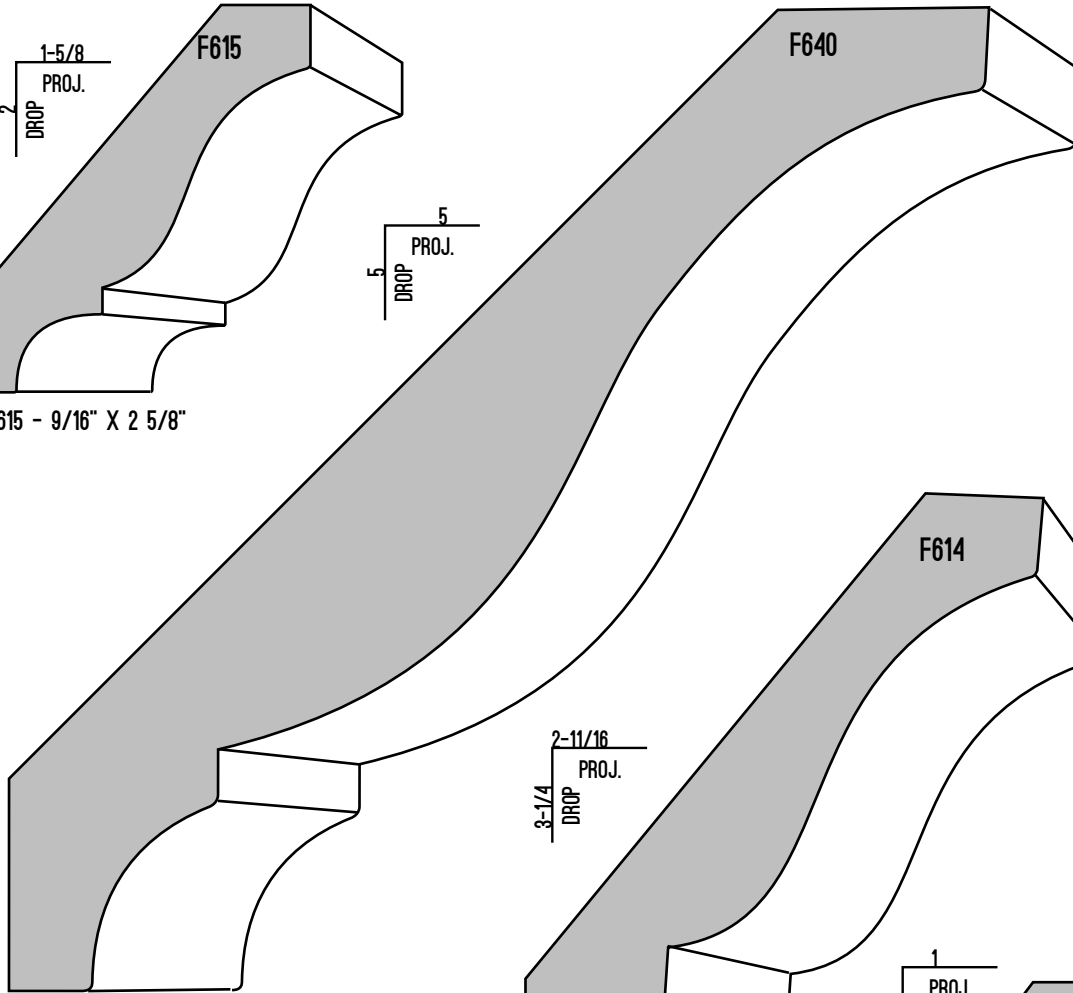

F640 - 1 1/16" X 7 1/4"

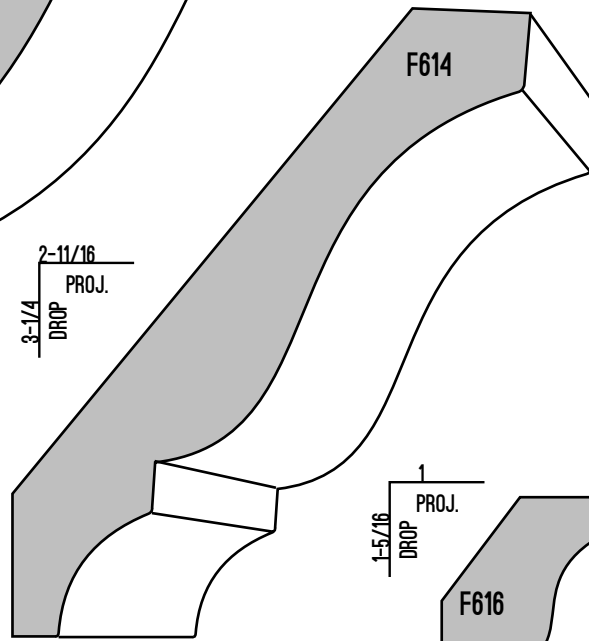

F614 - 11/16" X 4 1/4"

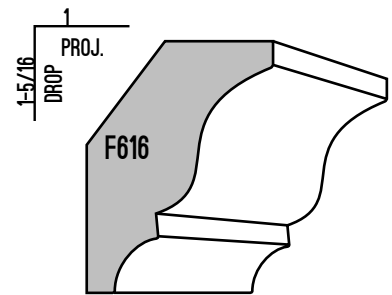

F616 - 9/16" X 1 5/8"

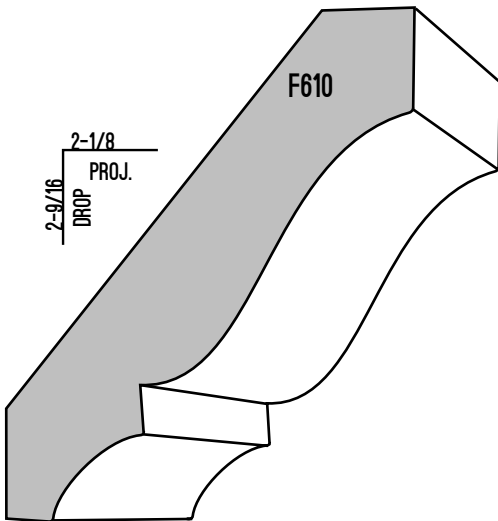

F610 - 11/16" X 3 7/16"

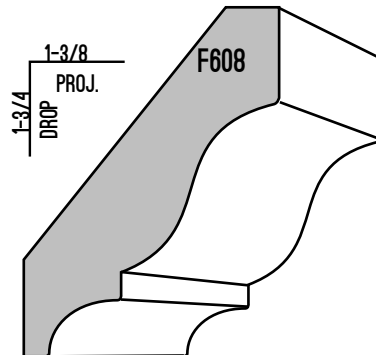

F608 - 9/16" X 2 1/4"

CROWNS

600 SERIES - CROWN MOULDING

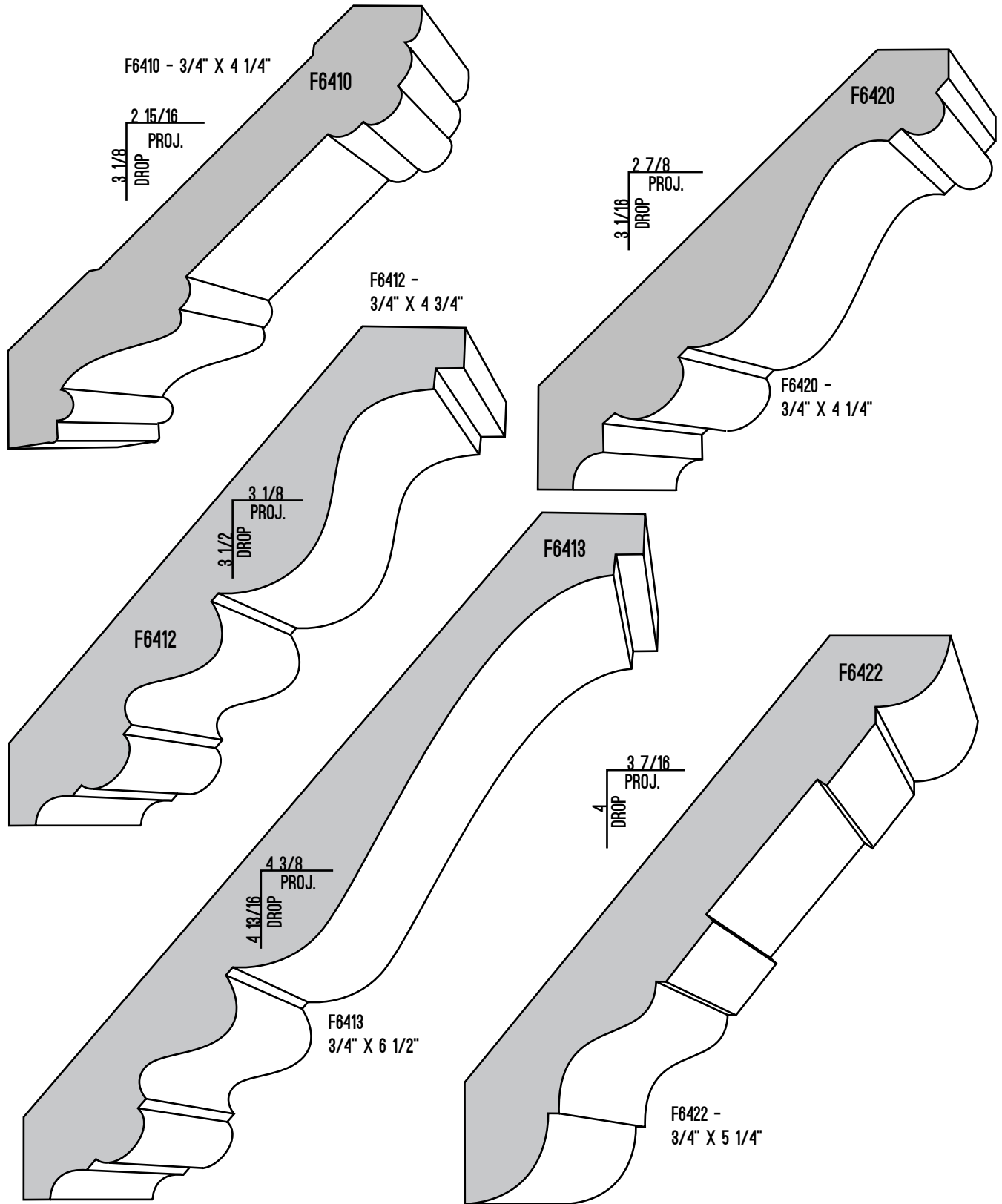

CROWNS

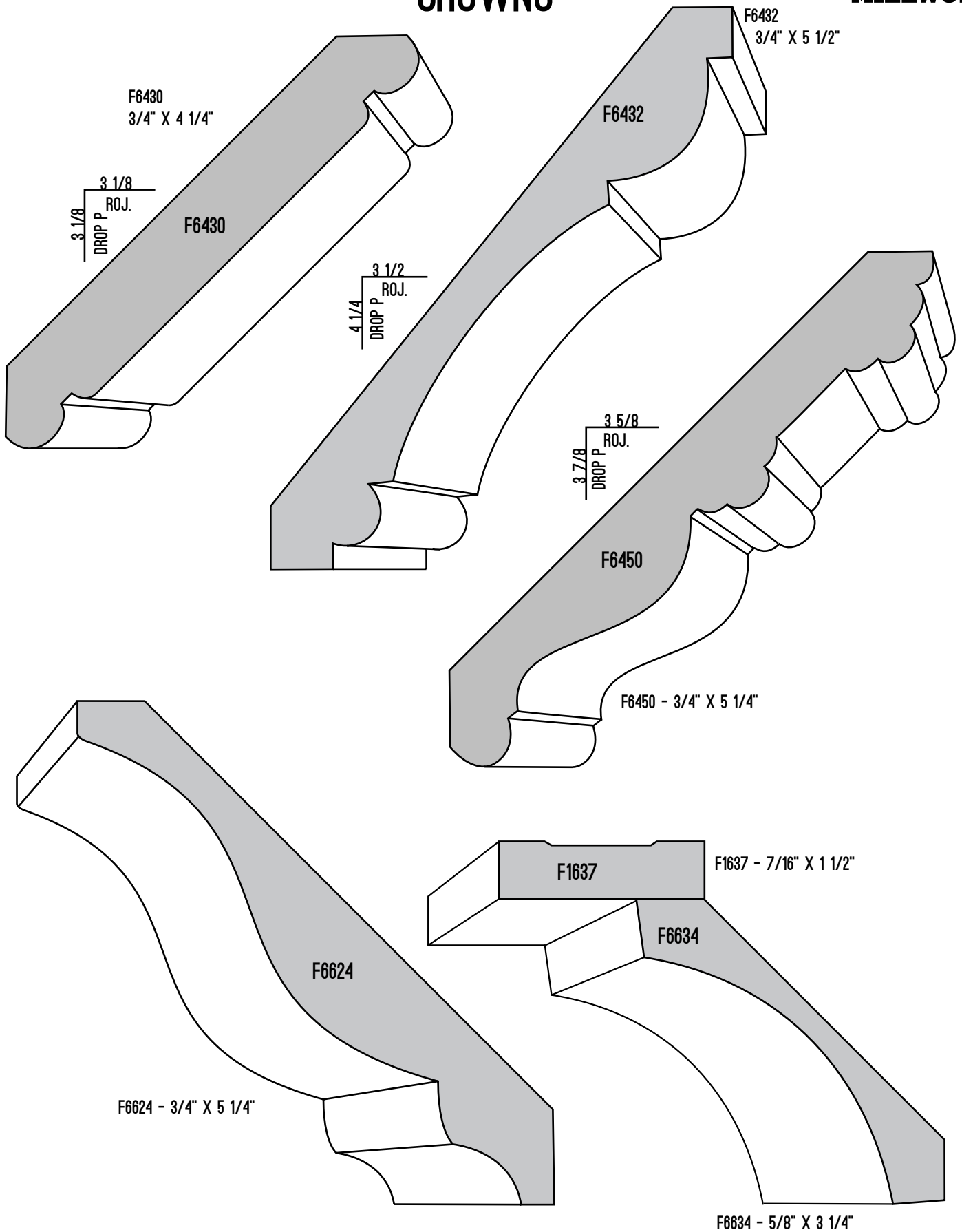

600 SERIES - CROWN MOULDING

CROWNS

600 SERIES - CROWN MOULDING

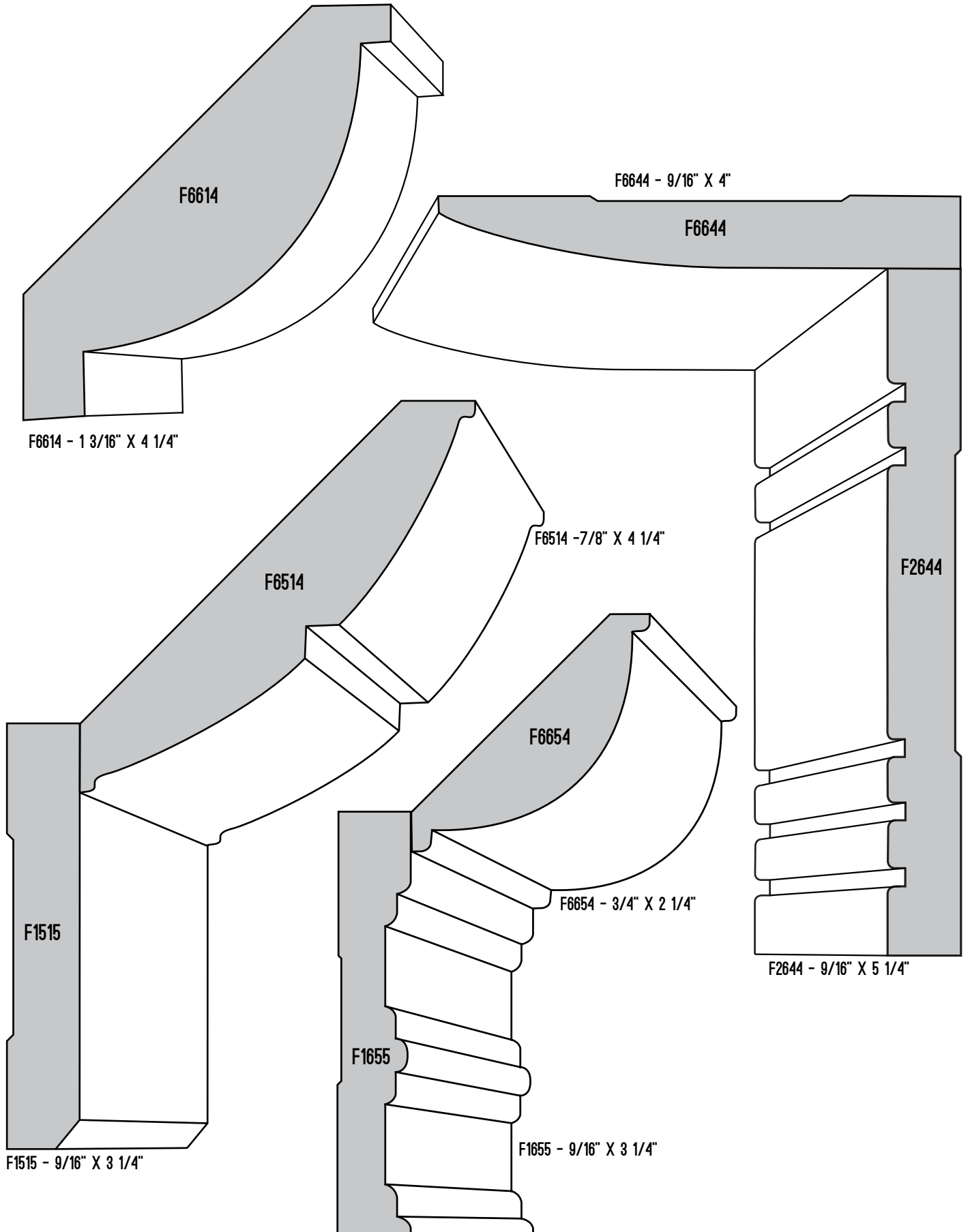

DENTIL CROWN

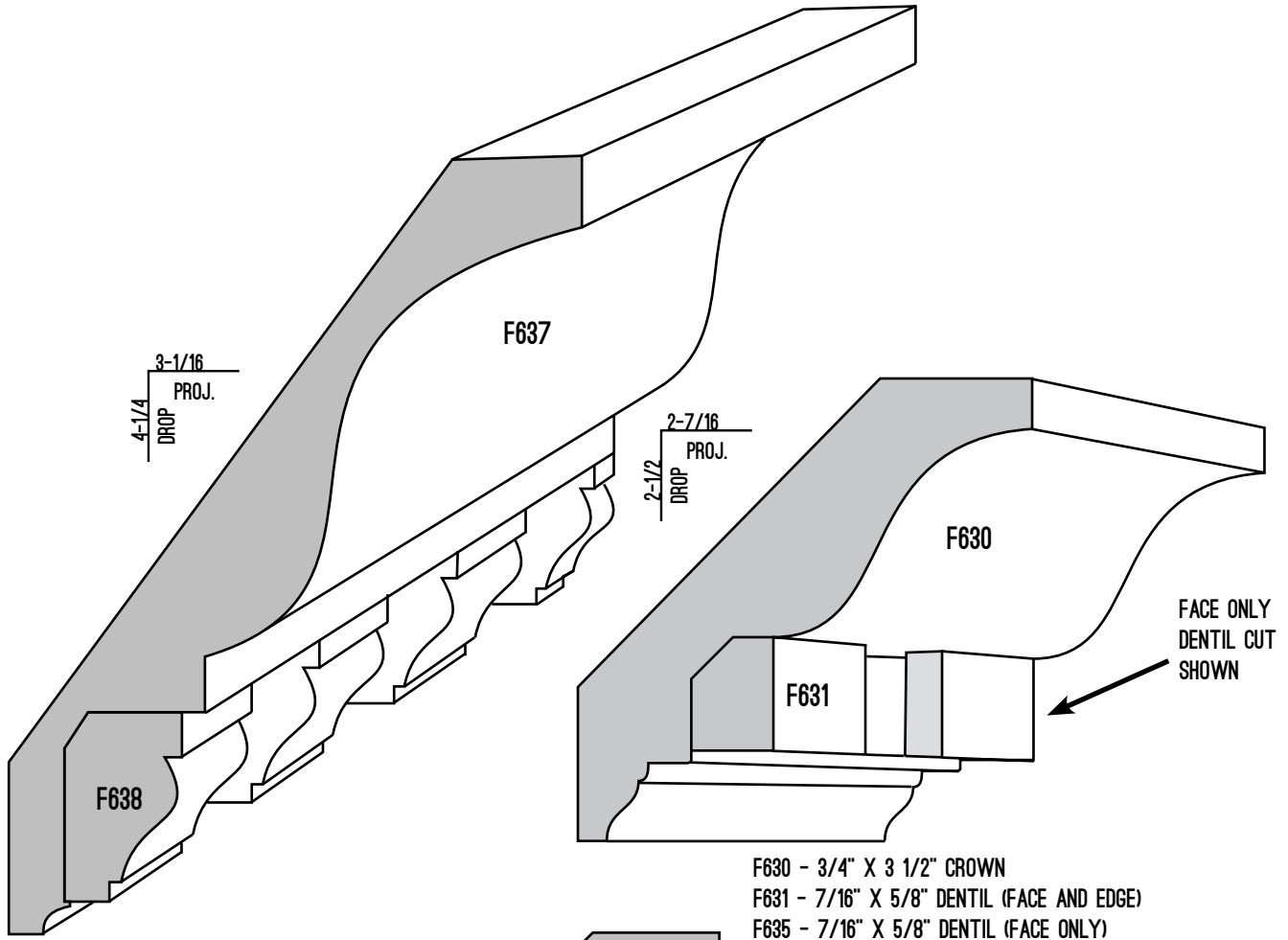

F637 - 3/4" X 5 1/4" CROWN
F638 - 5/8" X 1" DENTIL

F630 - 3/4" X 3 1/2" CROWN
F631 - 7/16" X 5/8" DENTIL (FACE AND EDGE)
F635 - 7/16" X 5/8" DENTIL (FACE ONLY)

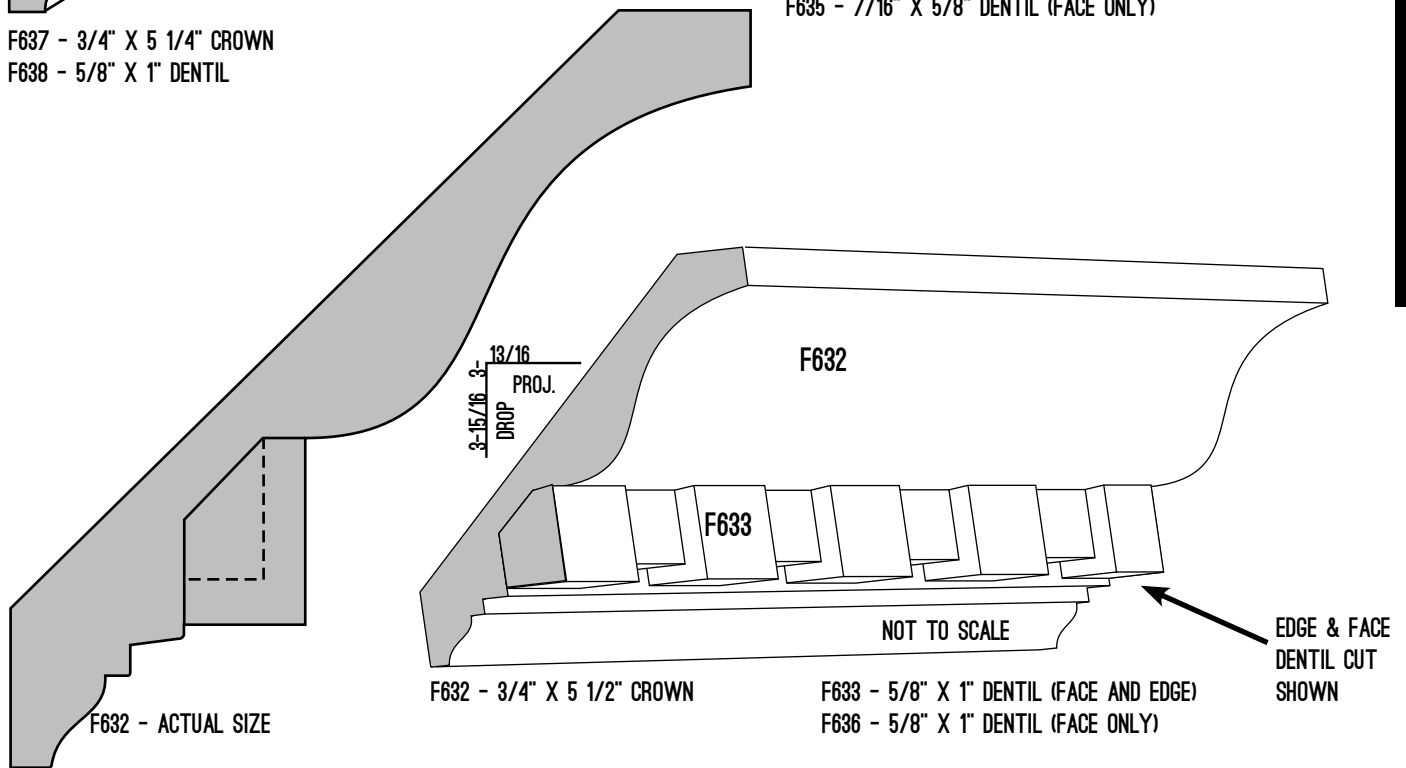

F632 - ACTUAL SIZE

F632 - 3/4" X 5 1/2" CROWN

F633 - 5/8" X 1" DENTIL (FACE AND EDGE)
F636 - 5/8" X 1" DENTIL (FACE ONLY)

600 SERIES - DENTIL CROWN

DENTIL MOULD

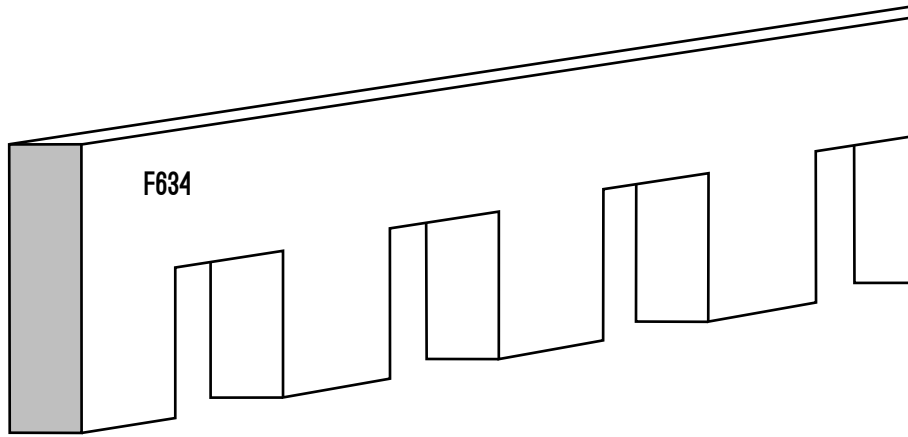

F634 - 3/8" X 1 1/2"

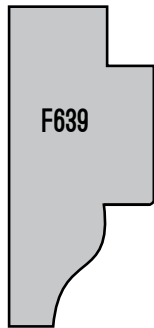

F639 - 3/4" X 1 5/8"

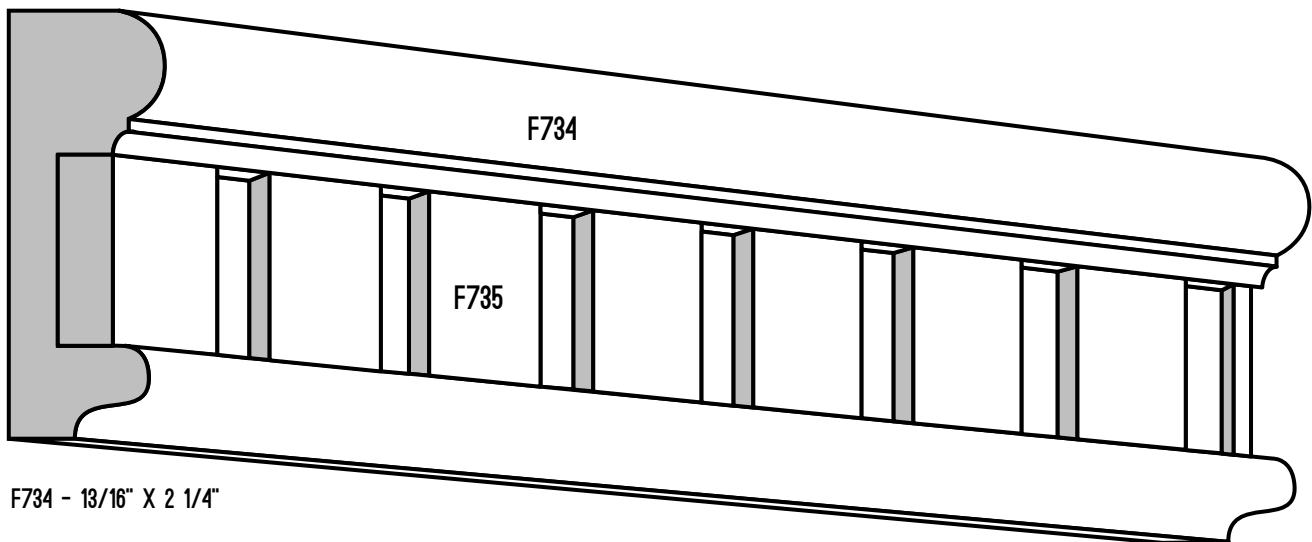
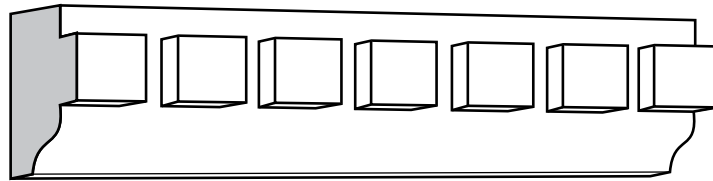

F734 - 13/16" X 2 1/4"

F735 - 9/32" X 1" DENTIL

INSIDE CROWN CORNER BLOCKS

F643 - 2 1/2" X 2 1/2" X 4"

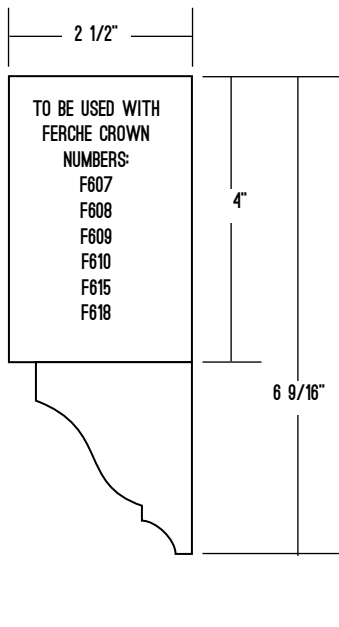

F644 - 3" X 3" X 4"

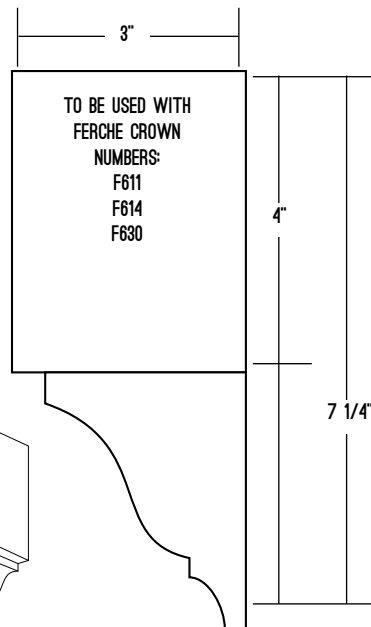

F645 - 4" X 4" X 4 1/2"

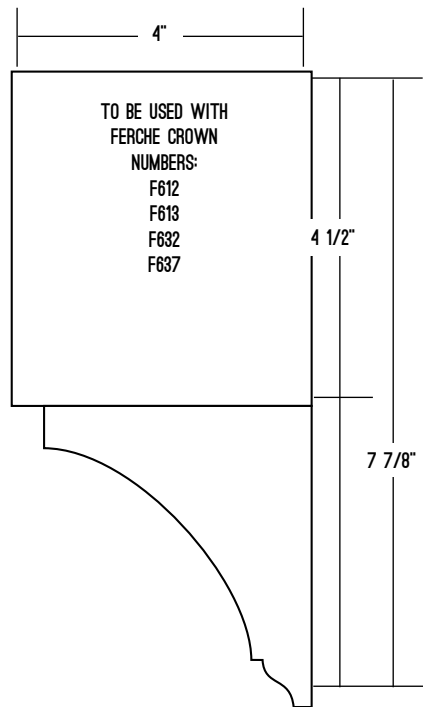

CORNER MOULDINGS

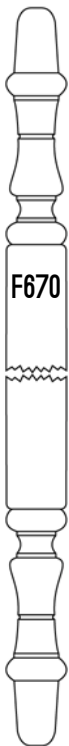

F670 -
1 1/4" X 48"
CORNER GUARD

OUTSIDE CORNER

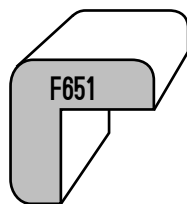

F651 -
3/4" X 3/4"

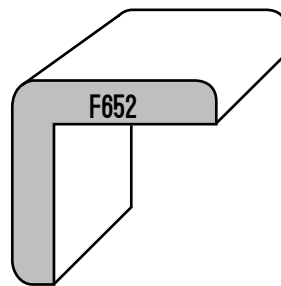

F652 -
1 1/16" X 1 1/16"

INSIDE CORNER

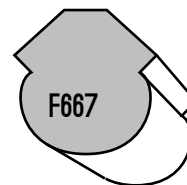

F667 -
3/4" X 3/4"



F660 -
9/16" X 1 1/8"

QUARTER ROUND

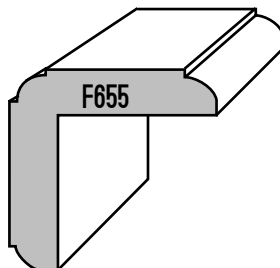

F655 -
1 1/16" X 1 1/16"

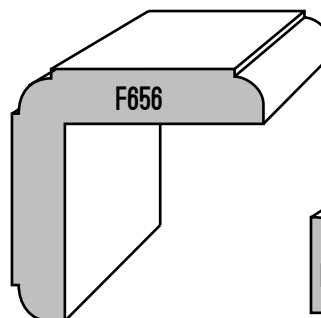

F656 -
1 5/16" X 1 5/16"

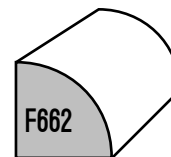

F662 -
1/2" X 1/2"

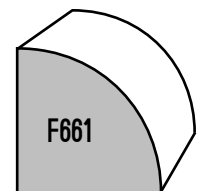

F661 -
3/4" X 3/4"

600 SERIES - INSIDE CROWN CORNER BLOCKS, CORNER MOULDINGS

PANEL MOULDINGS

700 SERIES - PANEL MOULDINGS

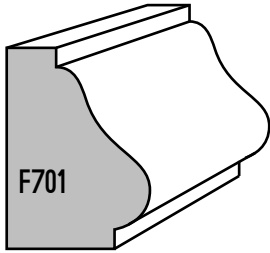

F701 - 3/4" X 1 1/16"

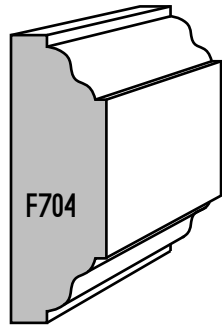

F704 - 1/2" X 1 1/2"

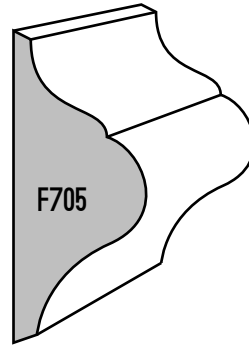

F705 - 11/16" X 1 5/8"

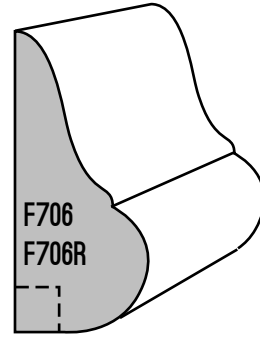

F706 - 11/16" X 1 5/8"
F706R - W/ 1/4" X 1/4" RABBET

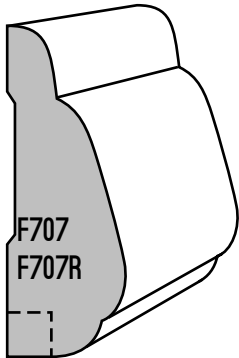

F707 - 5/8" X 1 3/4"
F707R - W/ 1/4" X 1/4" RABBET

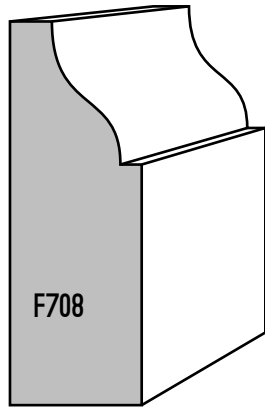

F708 - 11/16" X 2"

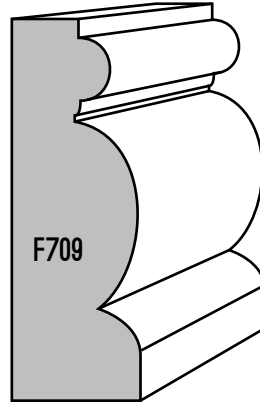

F709 - 11/16" X 2"

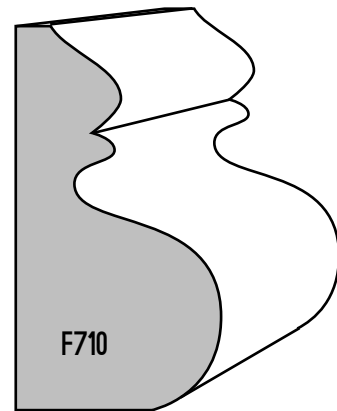

F710 - 1 1/16" X 2"

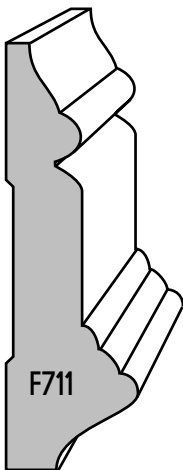

F711 - 11/16" X 2 1/4"

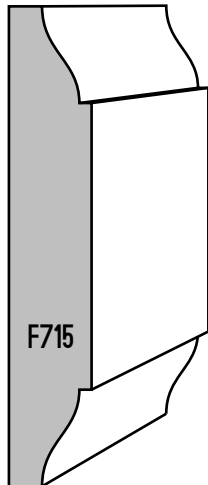

F715 - 7/16" X 2 1/2"

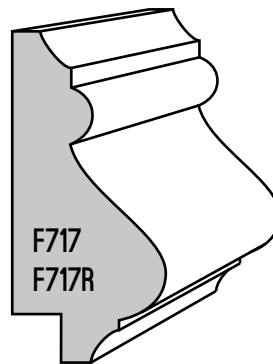

F717 - 13/16" X 1 3/4"
F717R - W/ 1/4" X 1/4" RABBET

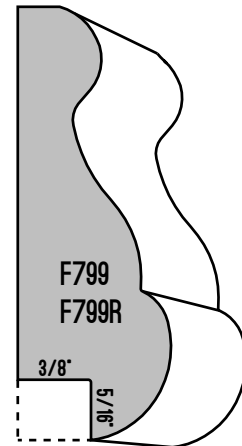

F799 - 13/16" X 2 1/4"
F799R - W/ 3/8" X 5/16" RABBET

PANEL MOULDINGS



F718 - 5/8" X 2 1/2"

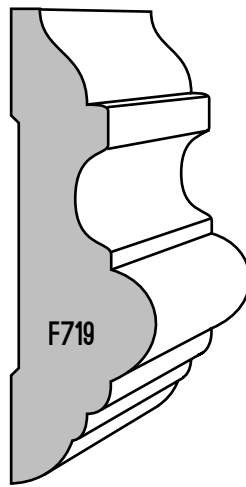

F719 - 3/4" X 2 1/2"

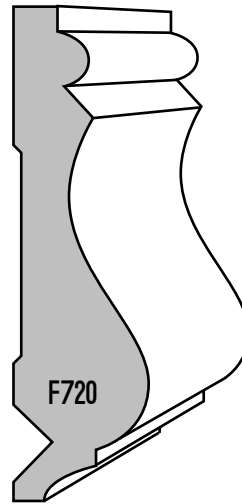

F720 - 11/16" X 2 5/8"

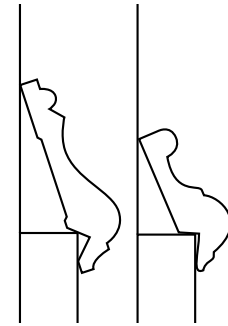

F720 /F721 INSTALLATION

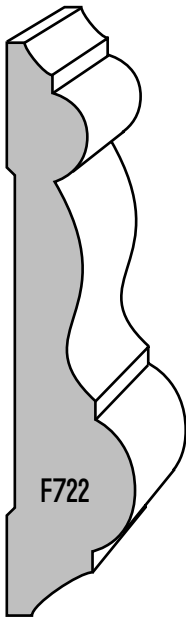

F722 - 11/16" X 3"

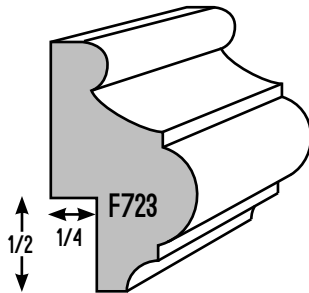

F723 - 3/4" X 1 5/16"

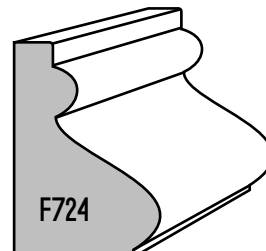

F724 - 3/4" X 1 1/8"

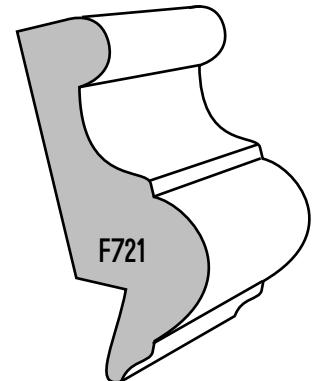

F721 - 11/16" X 2"



F726 - 1/2" X 3/4"

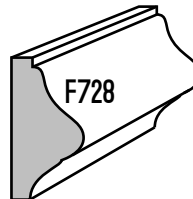

F728 - 3/8" X 3/4"

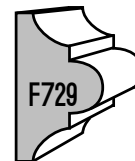

F729 - 7/16" X 3/4"

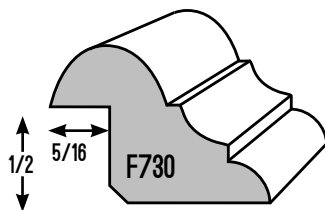

F730 - 9/16" X 1 3/16"

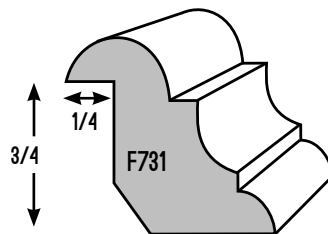

F731 - 9/16" X 1 5/16"

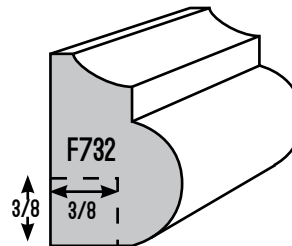

F732 - 11/16" X 1"
F732R - 11/16" X 1"

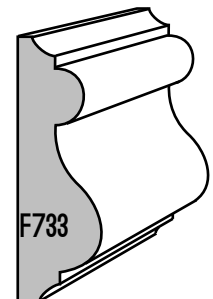

F733 - 7/16" X 1 3/8"

CHAIR RAILS

700 SERIES - CHAIR RAILS

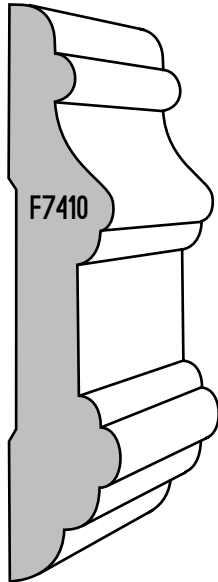

F7410
9/16" X 3"

F7412
5/8" X 3 1/2"

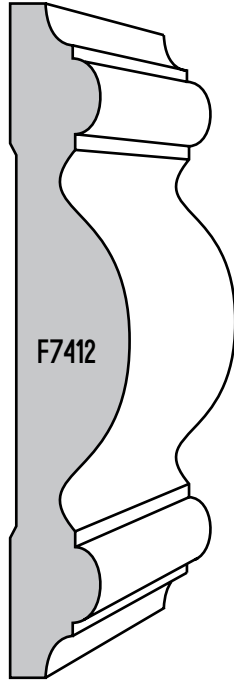

F7412

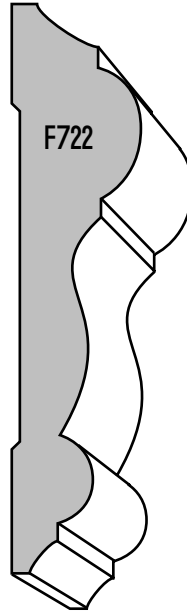

F722 -
11/16" X 3"

F7422 -
11/16" X 3 1/2"

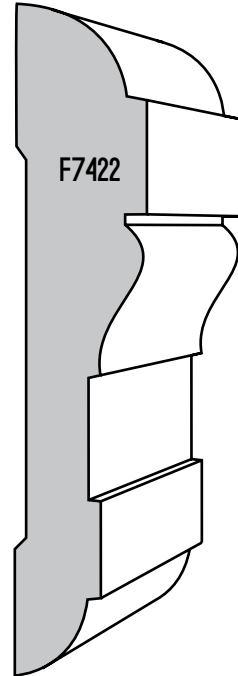

F7422

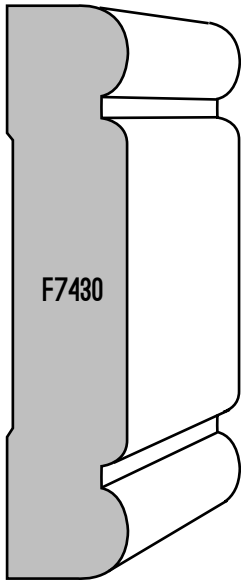

F7430
9/16" X 3"

F7432
5/8" X 3 1/2"

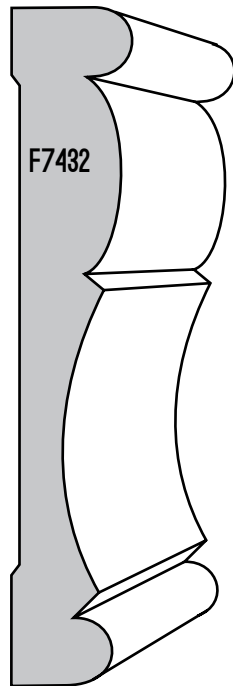

F7432

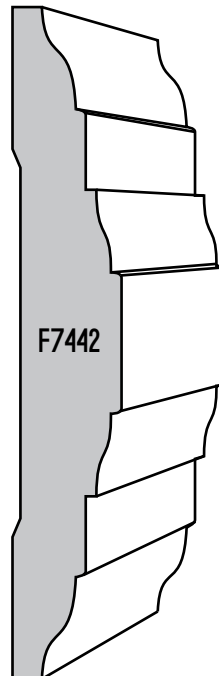

F7442 -
9/16" X 3 1/2"

F7450 -
3/4" X 3 1/4"

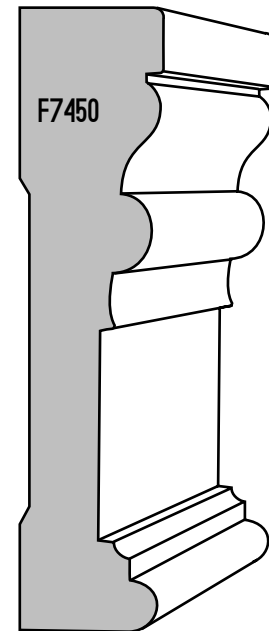

F7450

WANT MORE CHAIR RAILS?: Check out our Collections on pages 44-54 for additional chair rail options.

CHAIR RAILS

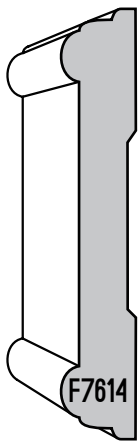

F7614 - 3/8" X 2 1/4"

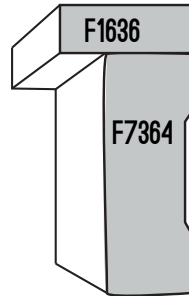

F7364 - 7/16" X 1 1/4"
F1636 CAP - 1/4" X 11/16"

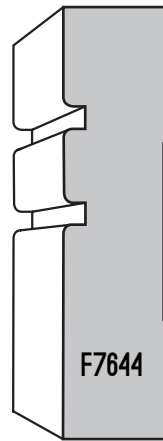

F7644 - 9/16" X 2 1/4"

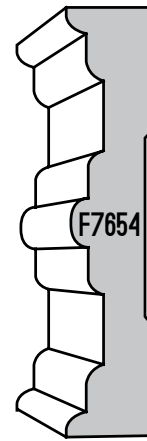

F7654 - 7/16" X 2 1/4"

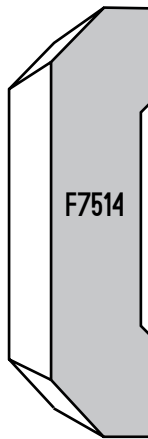

F7514 - 9/16" X 2 1/4"

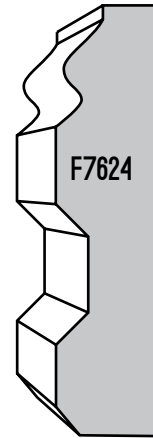

F7624 - 9/16" X 2 1/4"

700 SERIES - CHAIR RAILS

DENTIL CHAIR RAIL

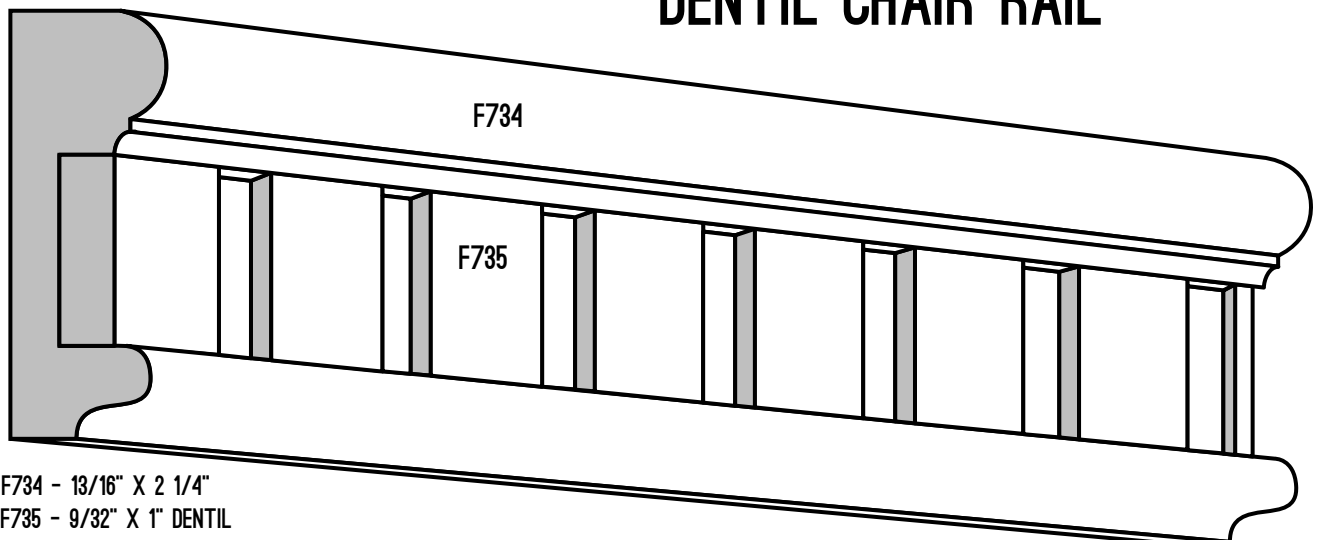

F734 - 13/16" X 2 1/4"
F735 - 9/32" X 1" DENTIL

TONGUE & GROOVE PANELING

PANELING COVERAGE

1 LFT.OF:= COVERAGE
 3 1/4" = .25 SQ.FT.
 4 1/4" = .33 SQ.FT.
 5 1/4" = .42 SQ.FT.

ADD FOR WASTE

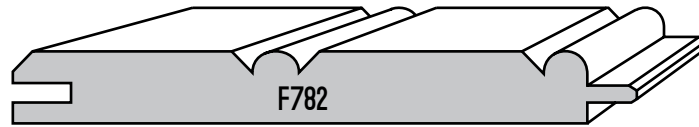

F782 - 3/8" X 3 1/4"

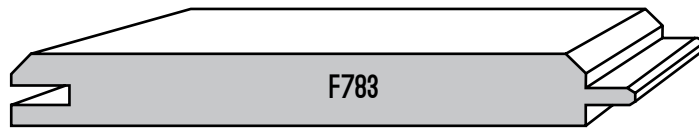

F783 - 3/8" X 3 1/4"

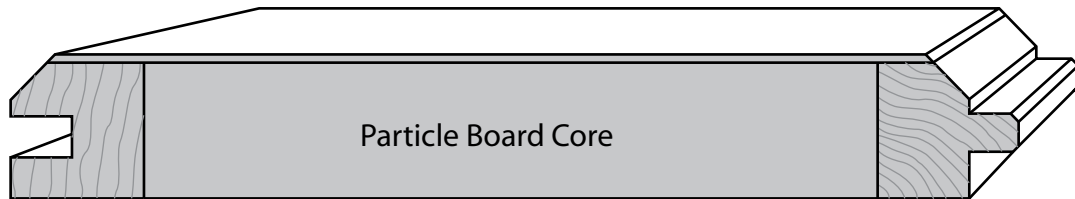

F765 - 3/4" X 5 1/4" (1000 LFT MINIMUM ORDER)
 (SPECIAL ORDER)

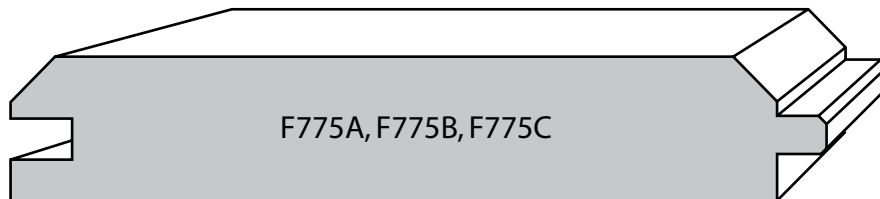

F775A - 3/4" X 3 1/4"
 F775B - 3/4" X 4 1/4"
 F775C - 3/4" X 5 1/4"

MANTEL MOULDINGS

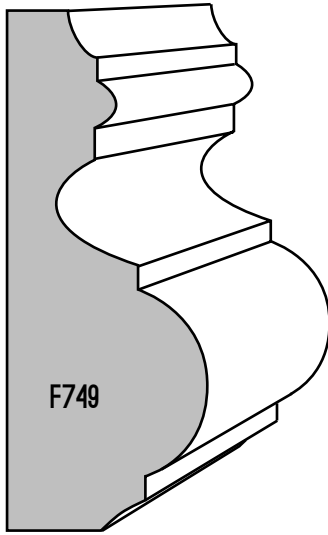

F749 - 1 1/16" X 2 3/4"

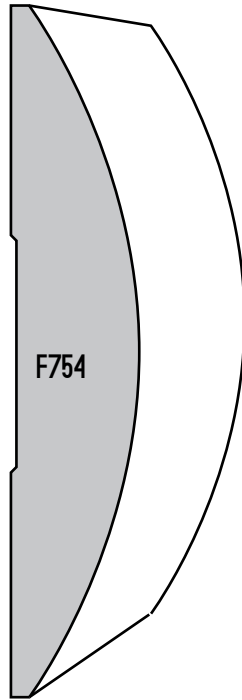

F754 - 1 1/16" X 3 5/8"

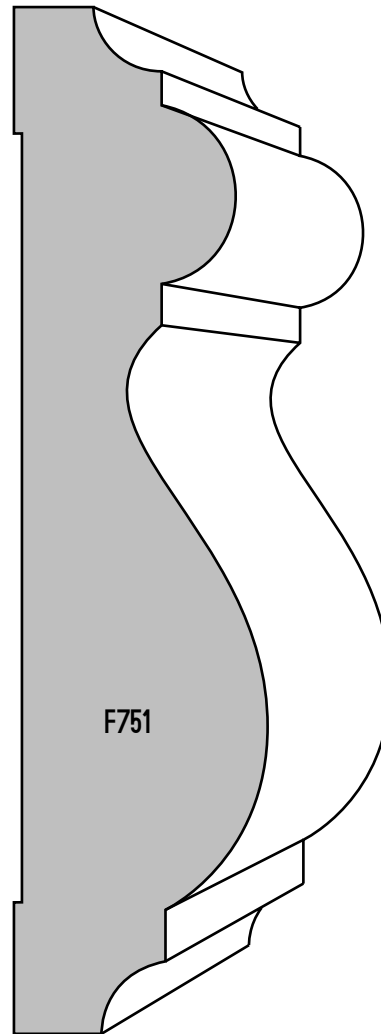

F751 - 1 5/16" X 5 3/8"

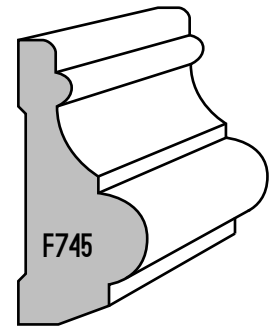

F745 - 1 1/16" X 1 1/2"

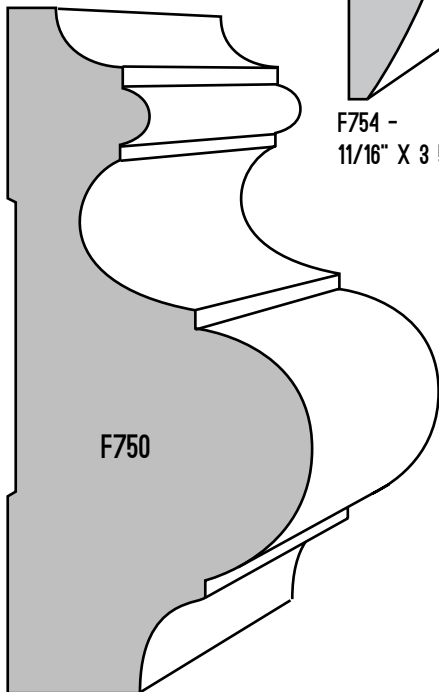

F750 - 1 5/8" X 3 5/8"

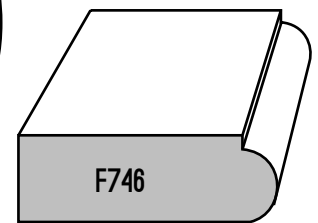

F746 - 7/16" X 1 3/8"

THRESHOLDS

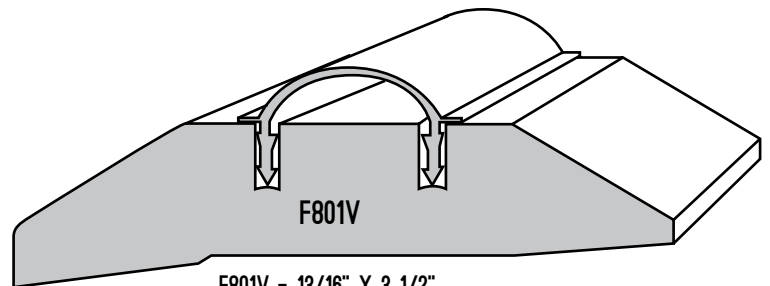

F801V - 13/16" X 3 1/2"

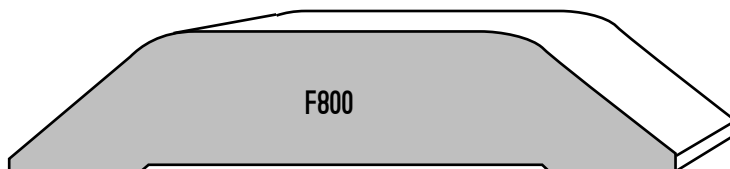

F800 - 3/4" X 3 1/2"

700 SERIES - MANTEL MOULDINGS | 800 SERIES - THRESHOLDS

HANDRAILS

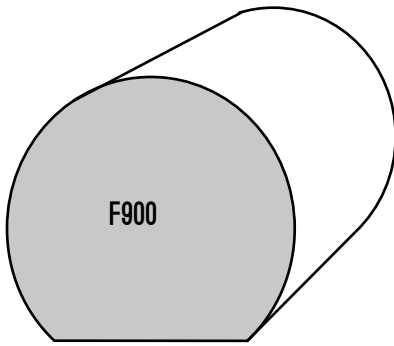

F900 - 1 3/8" X 1 1/2"

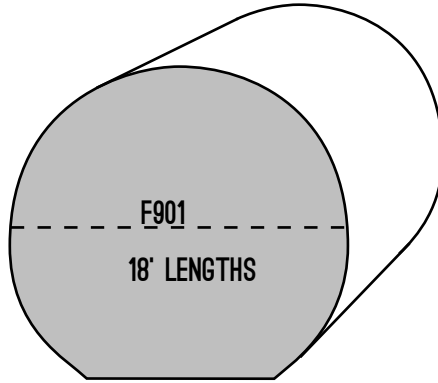

F901 - 1 5/8" X 1 3/4"
F901L (LAMINATED AND FINGERJOINTED)

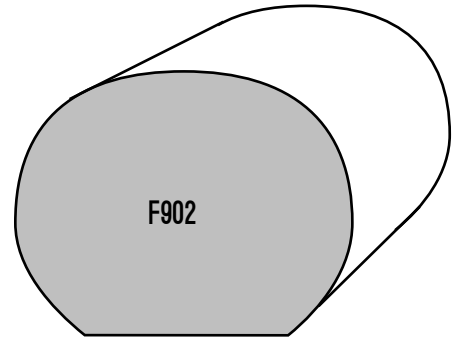

F902 - 1 3/8" X 1 3/4"

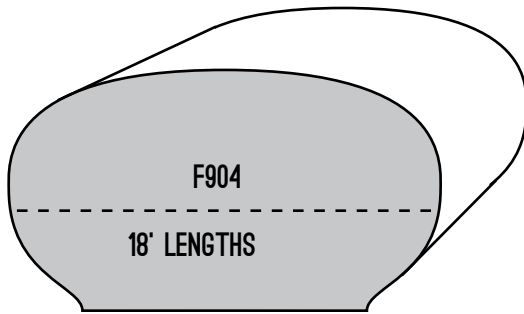

F904 - 1 1/4" X 2 1/4"
F904L (LAMINATED AND FINGERJOINTED)

NOTE:
Laminated and fingerjointed handrails available in lengths up to 18'. Solid handrails available in up to 16' lengths, depending on species.

BALUSTERS

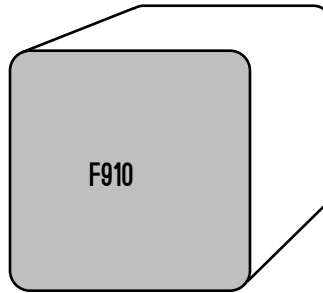

F910 - 1 1/4" X 1 1/4"

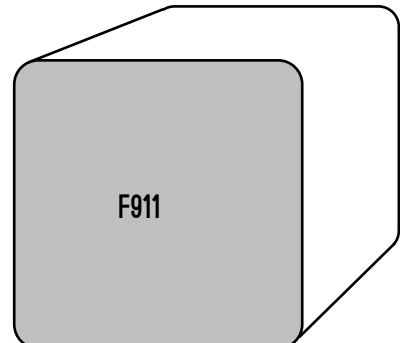

F911 - 1 1/2" X 1 1/2"

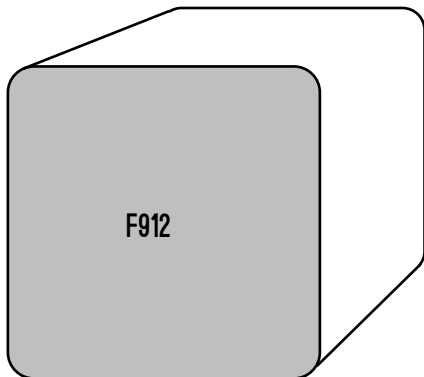

F912 - 1 5/8" X 1 5/8"

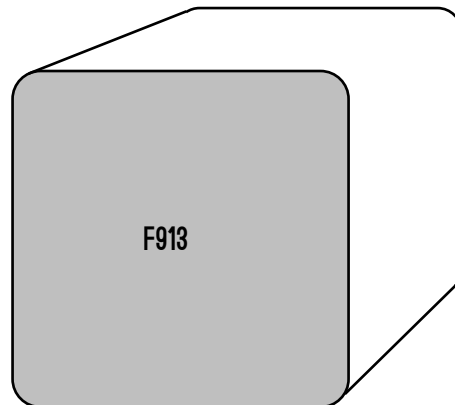

F913 - 1 3/4" X 1 3/4"

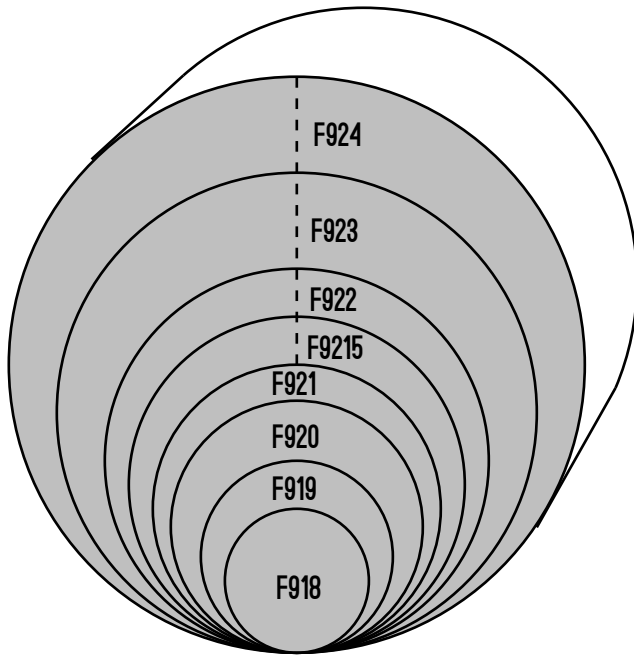

FULL ROUNDS

- F918 - 3/4"
- F919 - 1"
- F920 - 1 5/16"
- F921 - 1 1/2"
- F9215 - 1 3/4"
- F922 - 2"
- F923 - 2 1/2"
- F924 - 3"

HALF ROUNDS

- F940 - 3/8" X 3/4"
- F941 - 1/2" X 1"
- F942 - 3/4" X 1 1/2"
- F9425 - 7/8" X 1 3/4"
- F943 - 1" X 2"
- F944 - 1 1/4" X 2 1/2"
- F945 - 1 1/2" X 3"

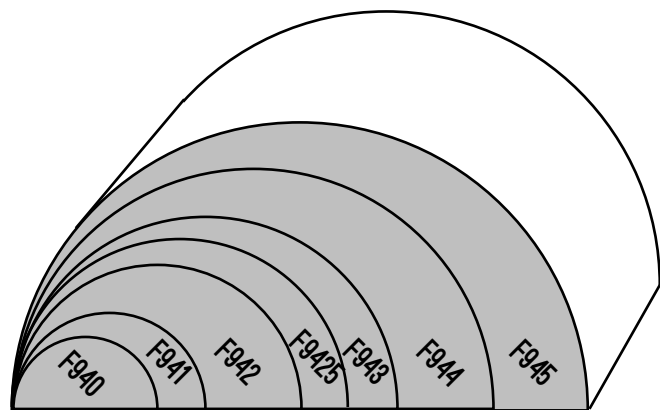

SAFETY RAILS

900 SERIES - SAFETY RAILS

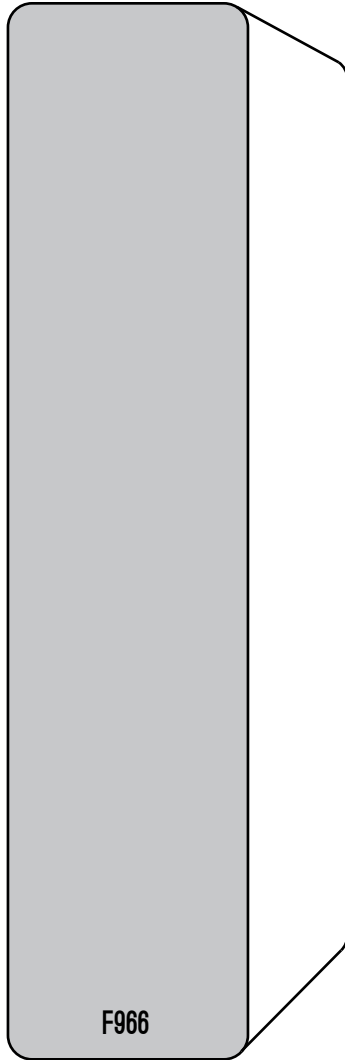

F966

F966 - 1 1/4" X 5 1/2"

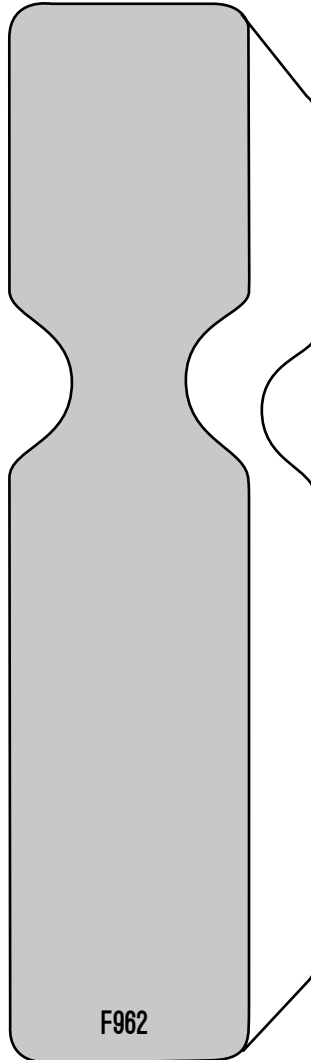

F962

F962 - 1 1/4" X 5 1/2"

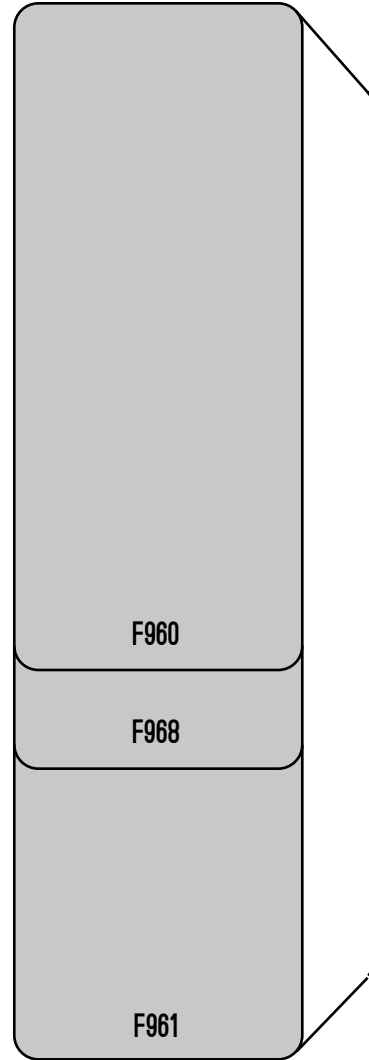

F960

F968

F961

F960 - 1 1/2" X 3 1/2"
F961 - 1 1/2" X 5 1/2"
F968 - 1 1/2" X 4"

SAFETY RAILS

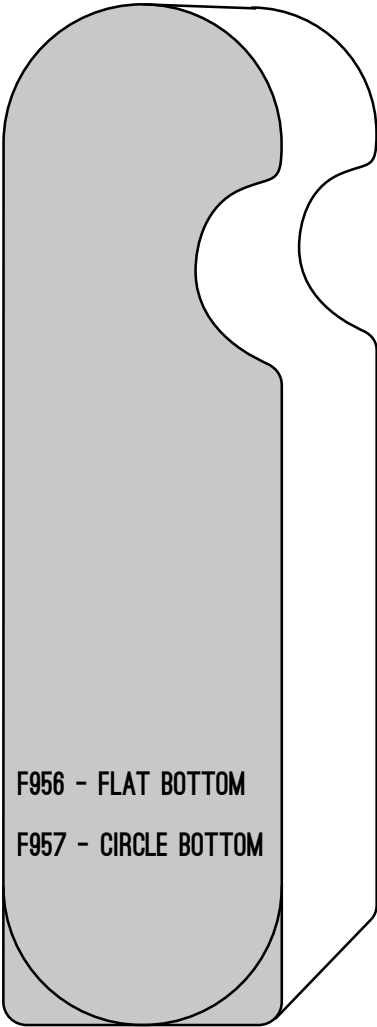

F956 - FLAT BOTTOM
F957 - CIRCLE BOTTOM

F956 - 1 1/2" X 5 1/2"
F957 - 1 1/2" X 5 1/2"

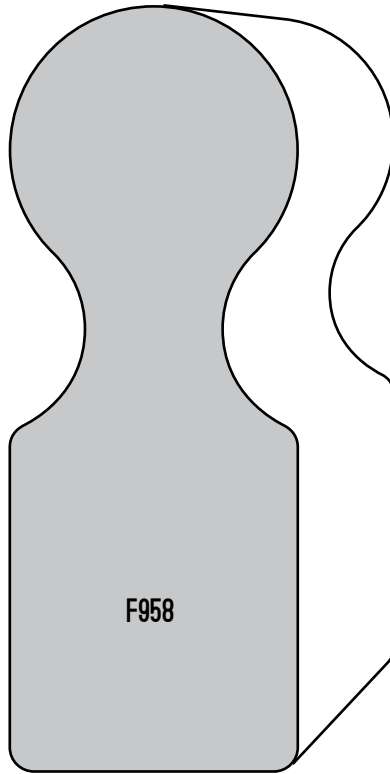

F958

F958 - 1 1/2" X 4"

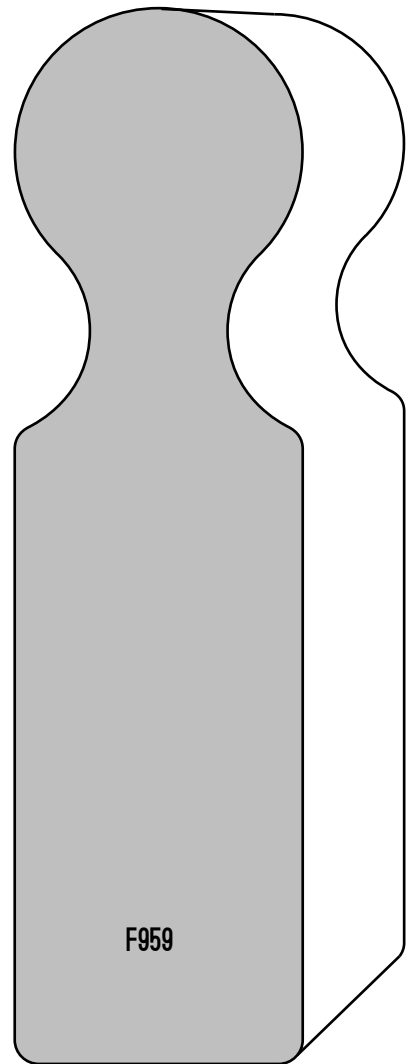

F959

F959 - 1 1/2" X 5 1/2"

STAIR PARTS

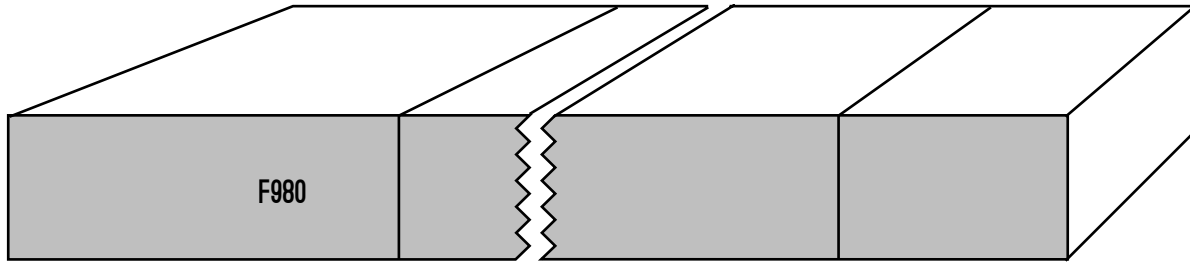

F980 - 3/4" X 7 1/2"

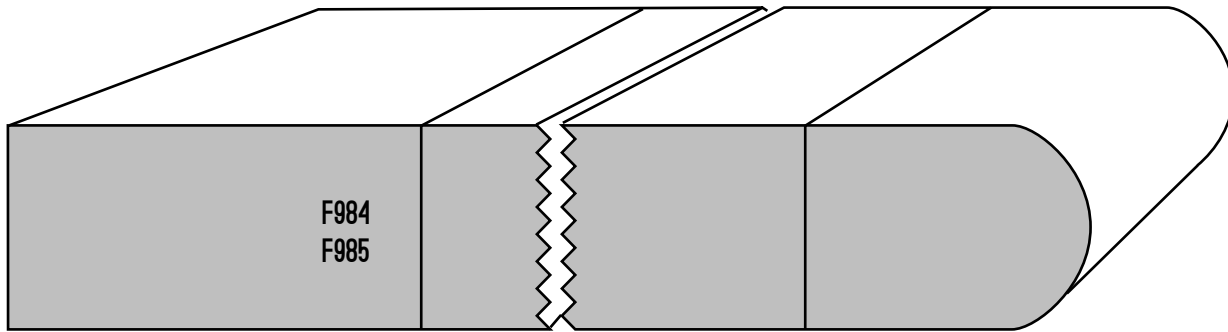

F984 - 1 1/16" X 10 1/2"

F985 - 1 1/16" X 11 1/2"

Add \$3.00 per return to list price for nonmitered machined returns. Add \$11.50/return to list price for mitered returns. Mitered returns will require 4 weeks for shipment.

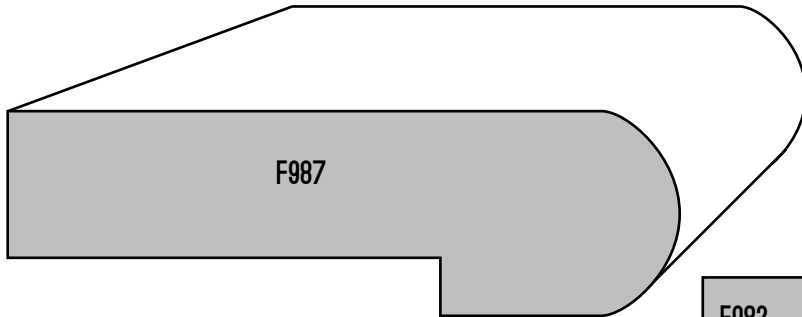

F987 - 1 1/16" X 3 1/2"

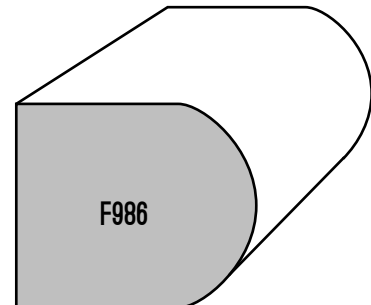

F986 - 1 1/16" X 1 1/4"

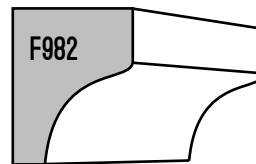

F982 - 5/8" X 13/16"



F988 - 1 1/16" X 5 1/2"

**VENEERED
SKIRTBOARDS
(MDF CORE)**

AVAILABLE IN LENGTHS
UP TO 18 FEET.

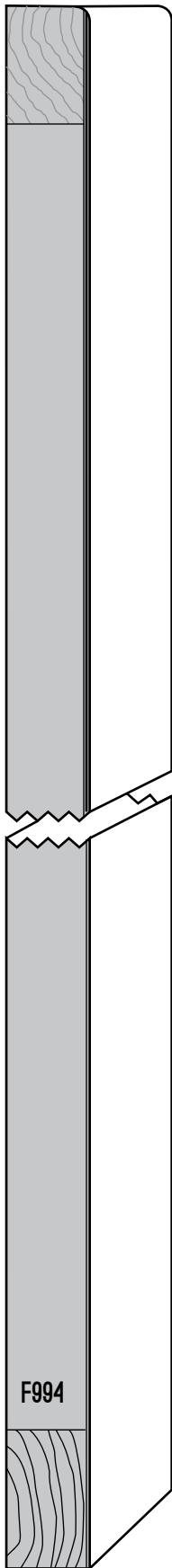

F994 - 7/16" X 9 1/4"
(SPECIAL ORDER)

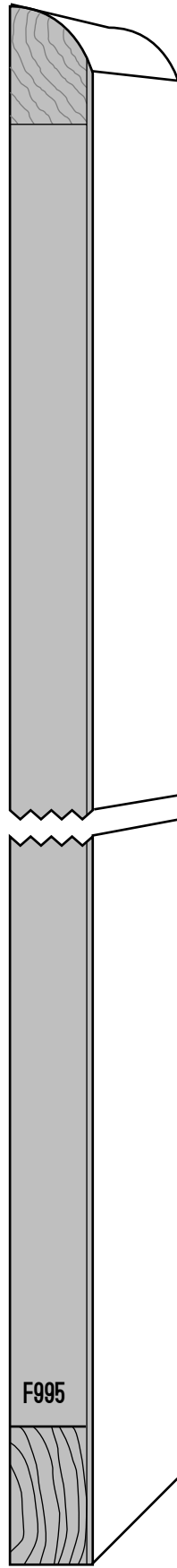

F995 - 7/16" X 9 1/4"

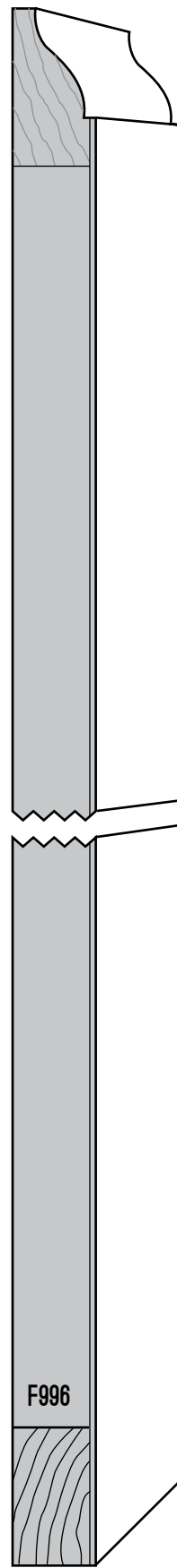

F996 - 7/16" X 9 1/4"

DECORATIVE HANDRAILS

SMALL QUANTITY SET-UP CHARGES MAY APPLY

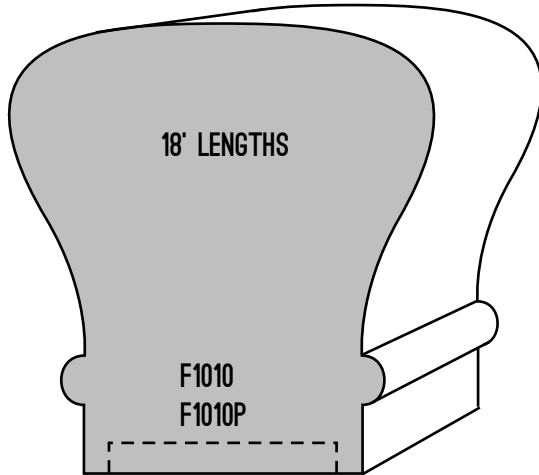

F1010 - 2 1/4" X 2 3/8"
F1010P - PLOWED 3/16" X 1 1/4"

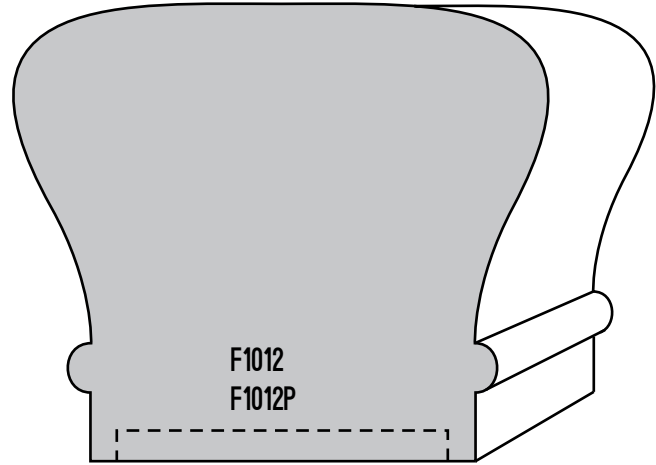

F1012 - 2 27/32" X 2 3/8"
F1012P - PLOWED 3/16" X 1 3/4"

The Plow is OPTIONAL on F1010 and F1012 - Please specify the "P" to indicate the Plow version.

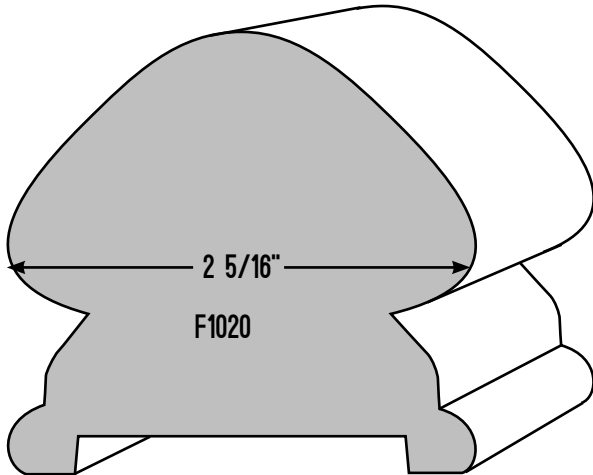

F1020 - 2 5/16" X 2 7/16"
PLOW - 3/16" X 1 3/4"

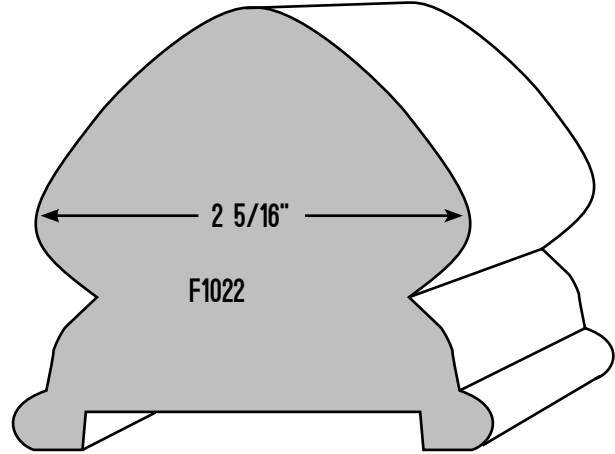

F1022 - 2 5/16" X 2 1/2"
PLOW - 3/16" X 1 3/4"

The Plow is STANDARD on F1020 and F1022

SHOE RAILS AND FILLETS

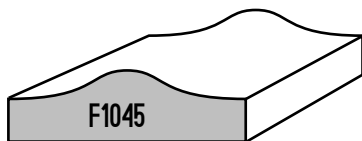

F1045 - 3/8" X 1 1/4"

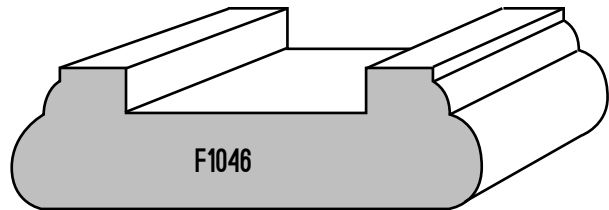

F1046 - 3/4" X 2 1/2"
F1046FJ - 3/4" X 2 1/2"(FINGERJOINTED)

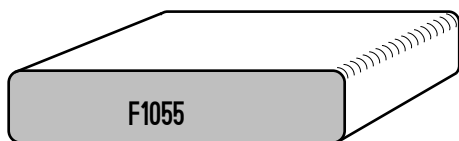

F1055 - 3/8" X 1 3/4"

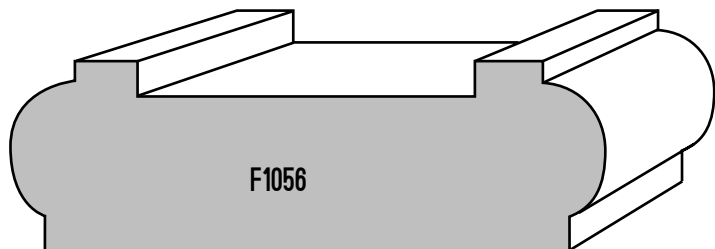

F1056 - 1" X 3 1/8"
F1056FJ - 1" X 3 1/8"(FINGERJOINTED)

1000 SERIES - DECORATIVE HANDRAIL, SHOE RAILS, FILLETS

THE **GRISHAM**

THE **AMHERST**

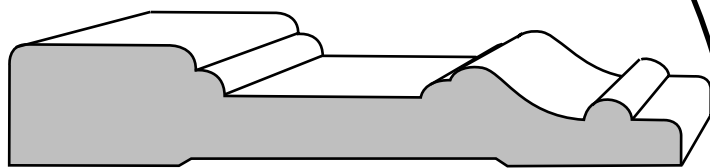

CASING F1410 - 5/8" X 3 1/2"

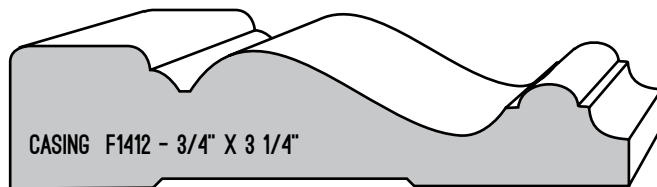

CASING F1412 - 3/4" X 3 1/4"

CROWN F6410 - 3/4" X 4 1/4"

2 15/16
PROJ.
3 1/8
DROP

CROWN F6412 - 3/4" X 4 3/4"

3 1/8
PROJ.
3 1/2
DROP

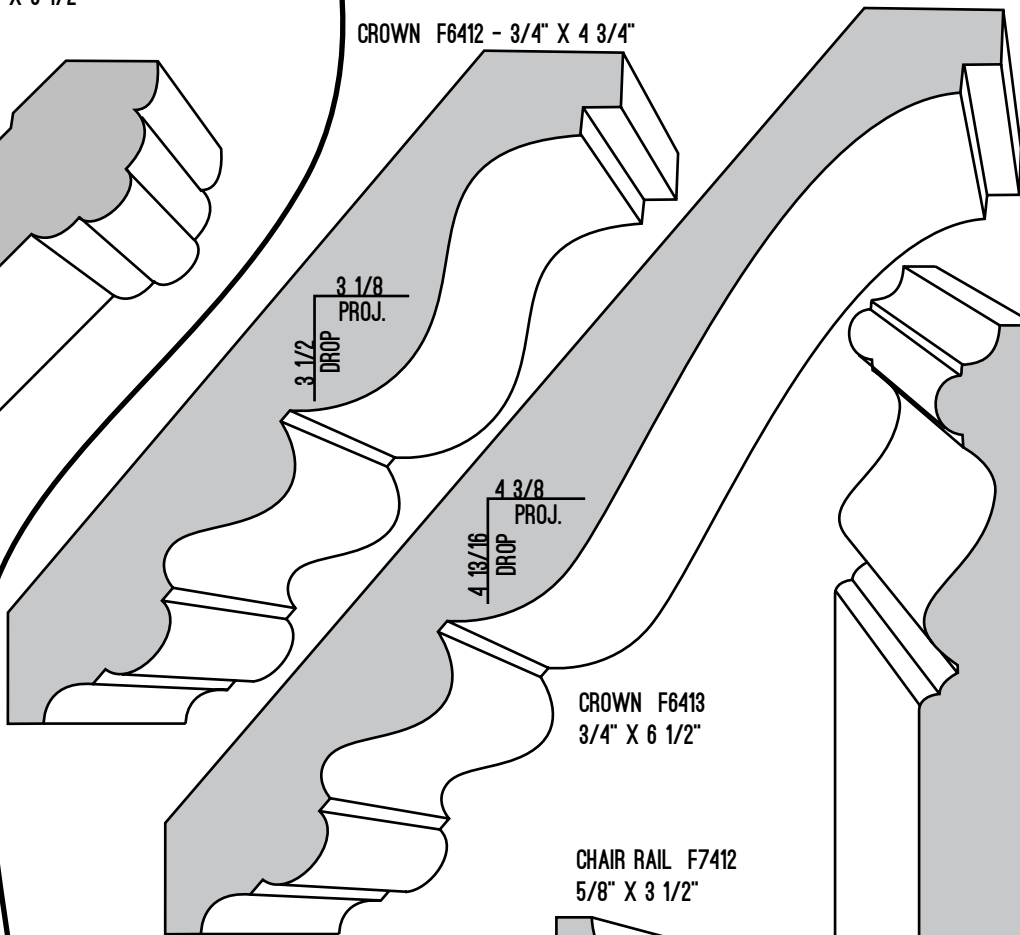
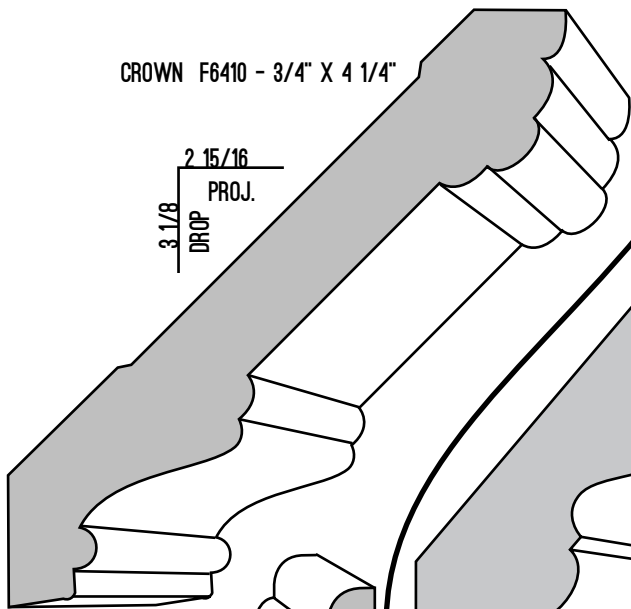

4 3/8
PROJ.
4 13/16
DROP

CROWN F6413
3/4" X 6 1/2"

CHAIR RAIL F7412
5/8" X 3 1/2"

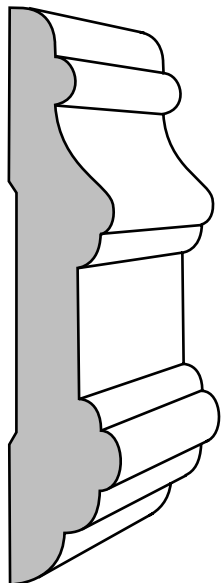

CHAIR RAIL F7410
9/16" X 3"

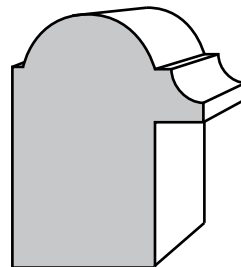

BACKBAND F1912
1" X 1 5/16"

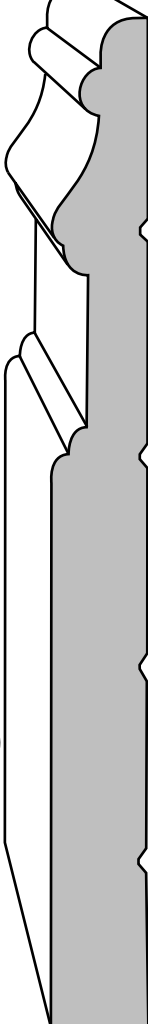

BASE F2410 - 1/2" X 5 1/4"

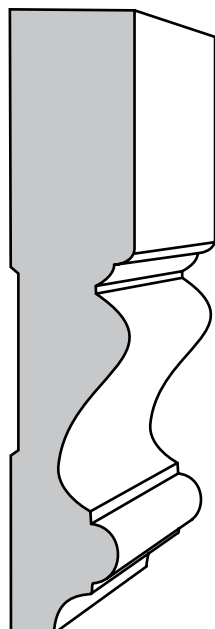

CROWN EXTENDER/APRON CASING
F1413 - 5/8" X 3 1/4"

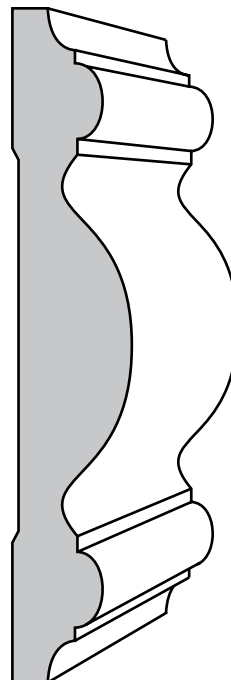

BASE F2412 - 5/8" X 7 1/4"

Decorative Series

FERCHE MILLWORK THE REDMOND

THE BRISTOL

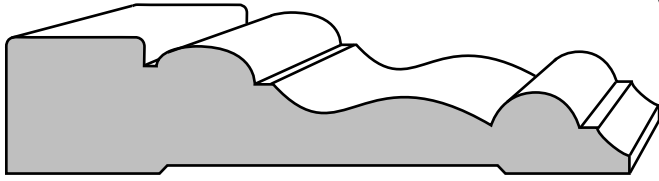

CASING F1420 - 3/4" X 3 1/4"

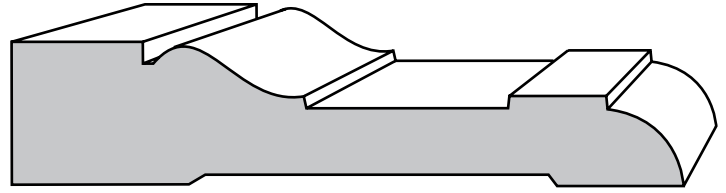

CASING F1422 - 3/4 X 3 1/2"

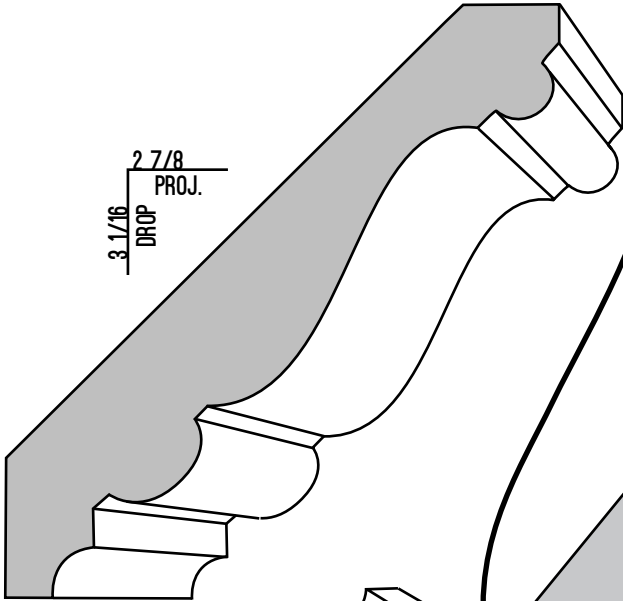

CROWN F6420 - 3/4" X 4 1/4"

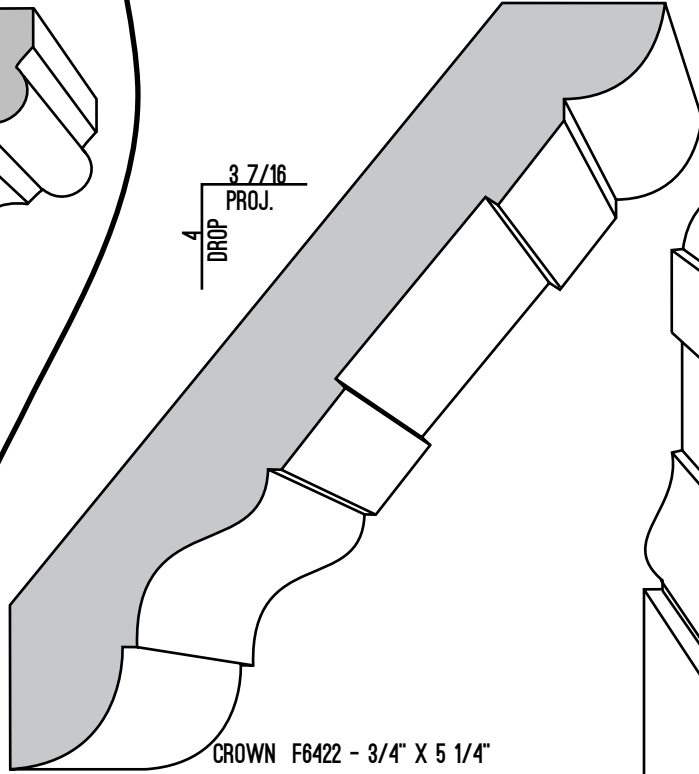

CROWN F6422 - 3/4" X 5 1/4"

CHAIR RAIL F722 - 11/16" X 3"

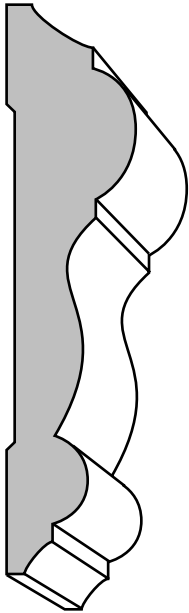

CHAIR RAIL F7422 - 11/16" X 3 1/2"

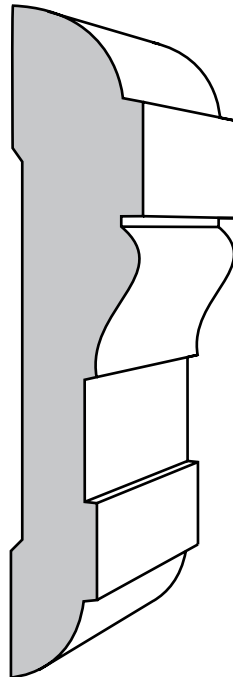

BASE F2420 - 1/2" X 5 1/4"

BASE F2422 - 5/8" X 7 1/4"

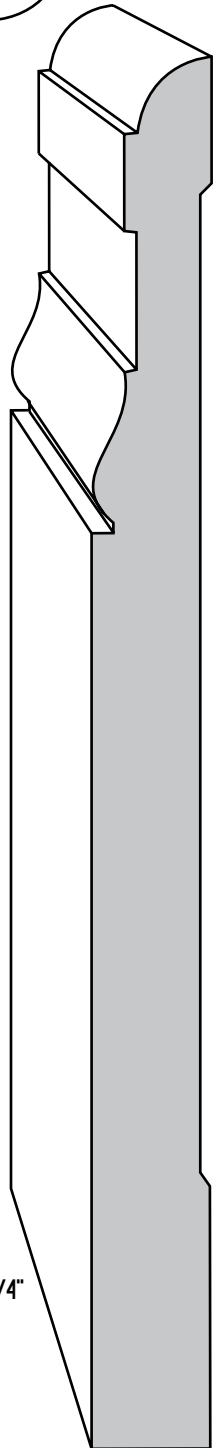

Decorator Series

THE BRADLEY

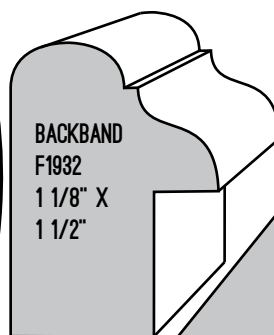
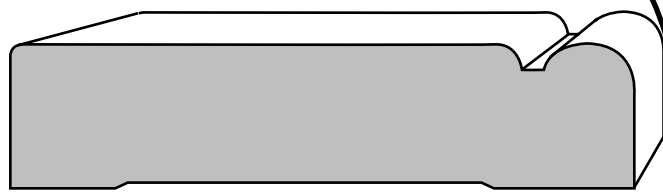
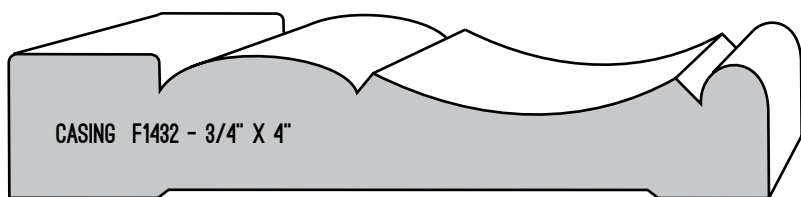

CROWN F6432
3/4" X 5 1/2"

CROWN F6430
3/4" X 4 1/4"

3 1/8
DROP P
ROJ.

3 1/2
ROJ.
4 1/4
DROP P

BASE F2432
5/8" X 7 1/4"

THE HAMPDEN

CROWN EXTENDER/APRON/CASING
F1433 - 5/8" X 3 1/2"

BASE F2430
1/2" X 5 1/4"

CHAIR RAIL F7430
9/16" X 3"

CHAIR RAIL F7432
5/8" X 3 1/2"

Decorative Series

THE **MULLEN**

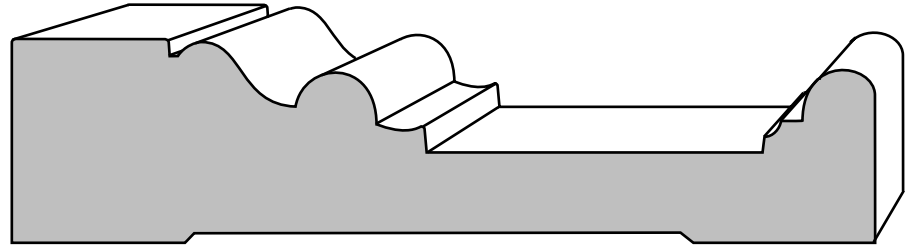

CASING F1450 - 1 1/16" X 4 1/2"

**EXPANDED MULLEN
FRIEZE BOARD**

CAP F617 - 1 1/16" X 2 1/2"

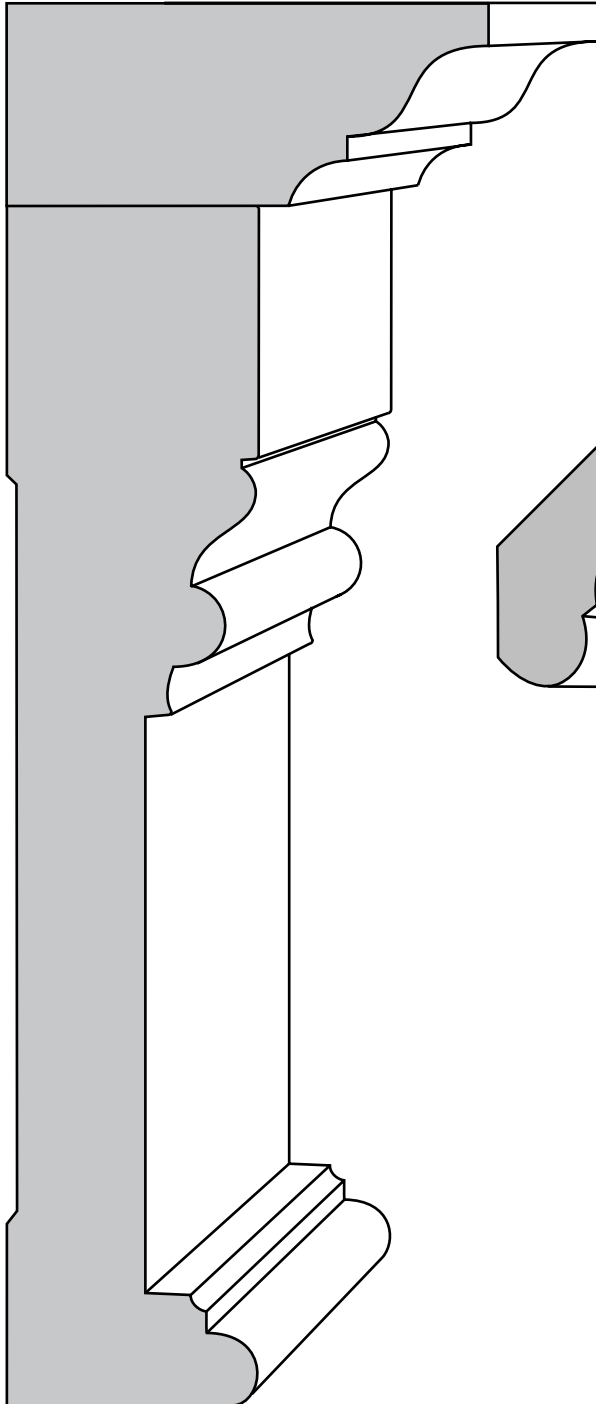

FRIEZE BOARD F1451 - 1 5/16" X 6 1/4"

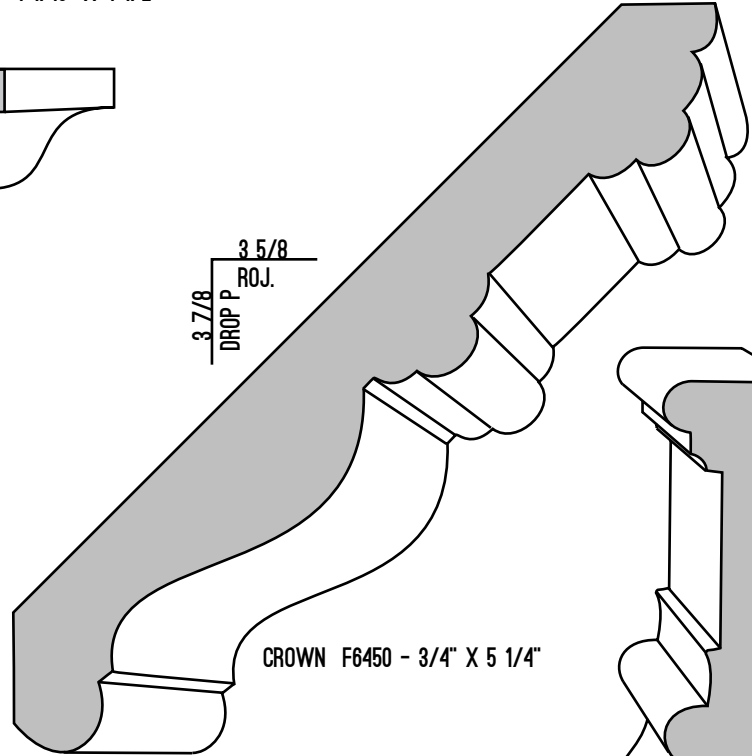

CROWN F6450 - 3/4" X 5 1/4"

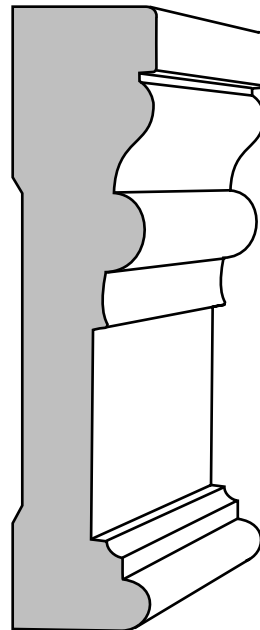

CHAIRRAIL F7450 - 3/4" X 3 1/4"

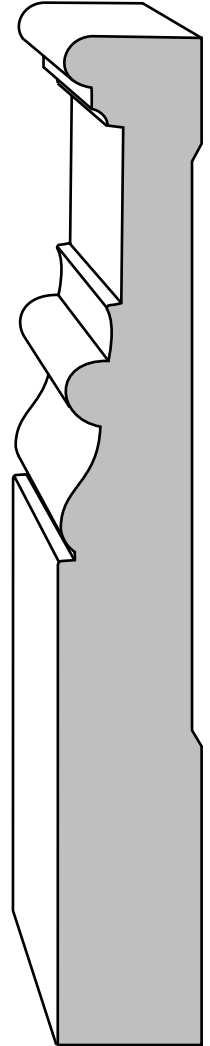

BASE F2450 - 11/16" X 5 1/4"

Decorator Series

THE **MANCHESTER**

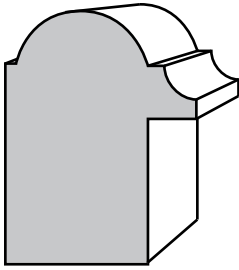

BACKBAND F1912 - 1" X 1 5/16"

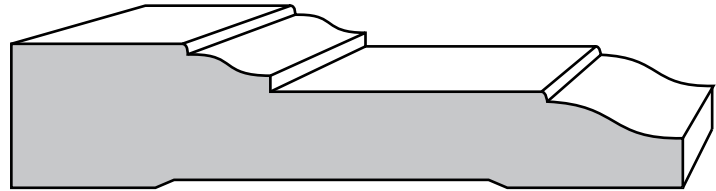

CASING F1442 - 3/4" X 3 1/2"

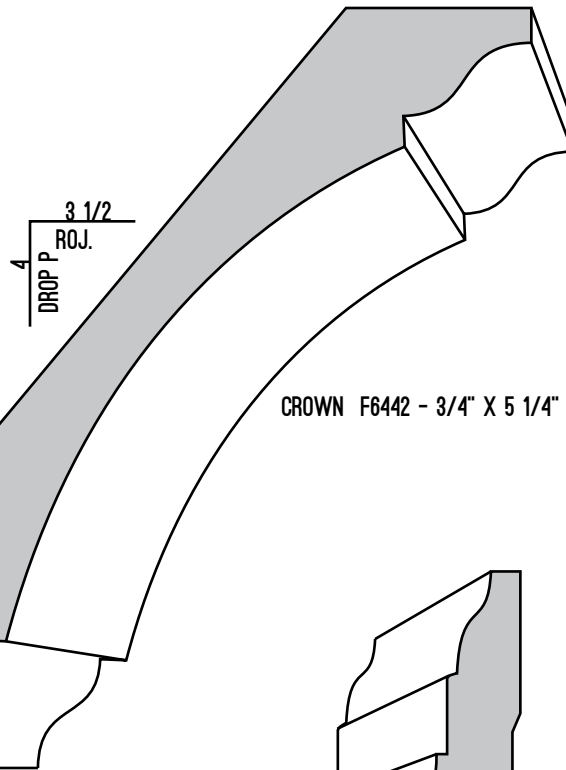

CROWN F6442 - 3/4" X 5 1/4"

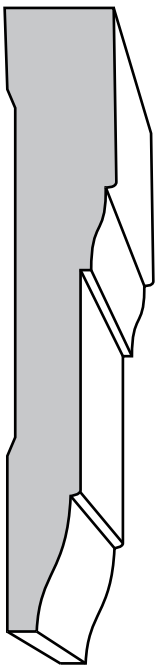

CROWN EXTENDER/APRON/CASING
F1443 - 9/16" X 3 1/4"

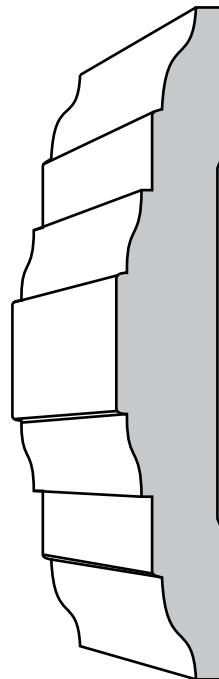

CHAIRRAIL F7442 - 9/16" X 3 1/2"

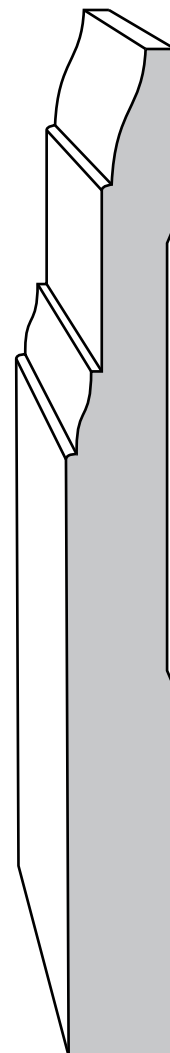

BASE F2442 - 9/16" X 5 1/4"

Decorative Series

PRINCETON

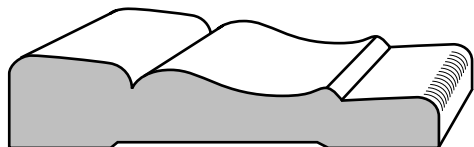

CASING F115 - 1/2" X 2 1/4"

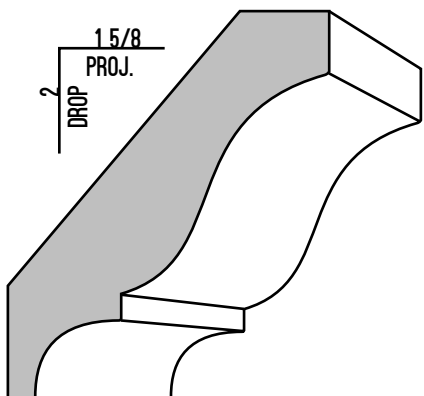

CROWN F615 - 9/16" X 2 5/8"

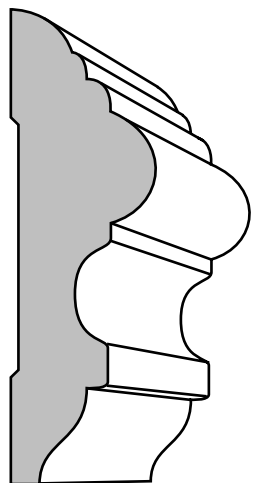

CHAIRRAIL F719 - 3/4" X 2 1/2"

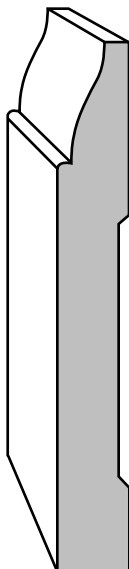

BASE F219 - 3/8" X 2 3/4"

RANCH

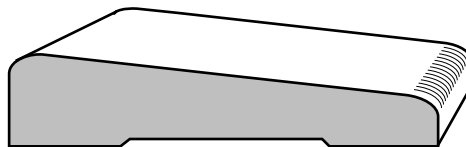

CASING F113 - 1/2" X 2 1/4"

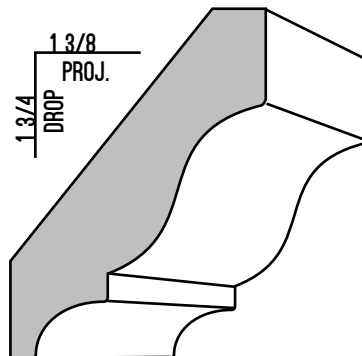

CROWN F608 - 9/16" X 2 1/4"

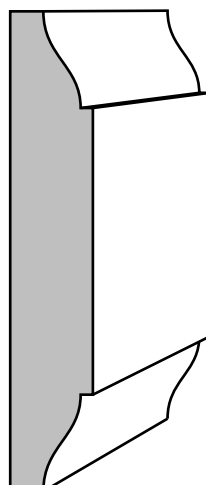

CHAIRRAIL F715 - 7/16" X 2 1/2"

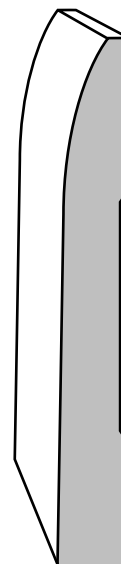

BASE F206 - 3/8" X 2 3/4"

STANDARD SERIES

HEAVY PRINCETON

FLAT

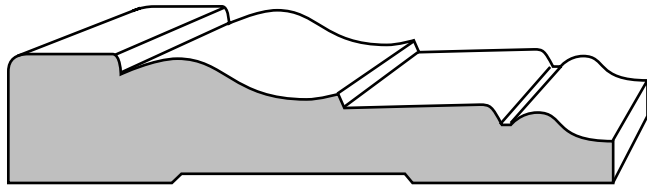

CASING F132 - 11/16" X 3 1/4"

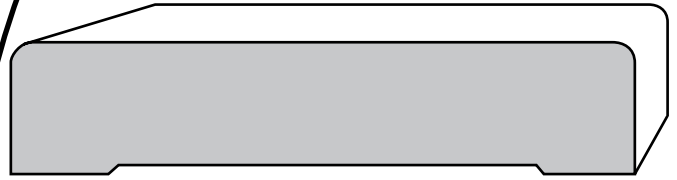

CASING F153 - 11/16" X 3 1/4"

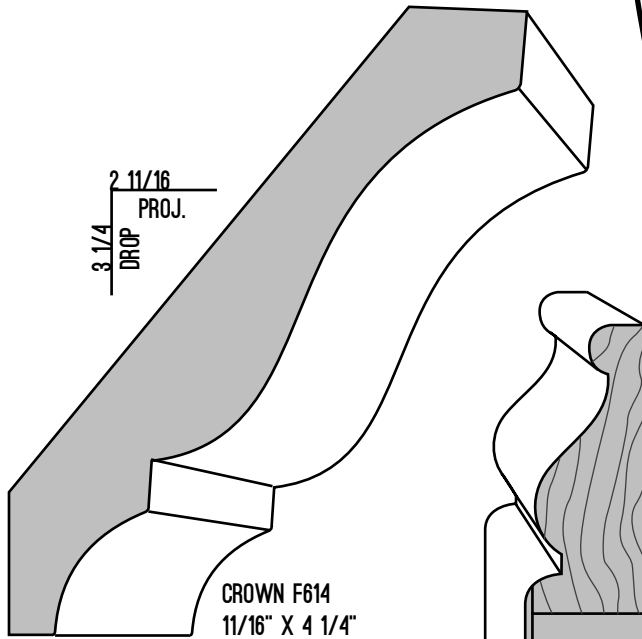

CROWN F614
11/16" X 4 1/4"

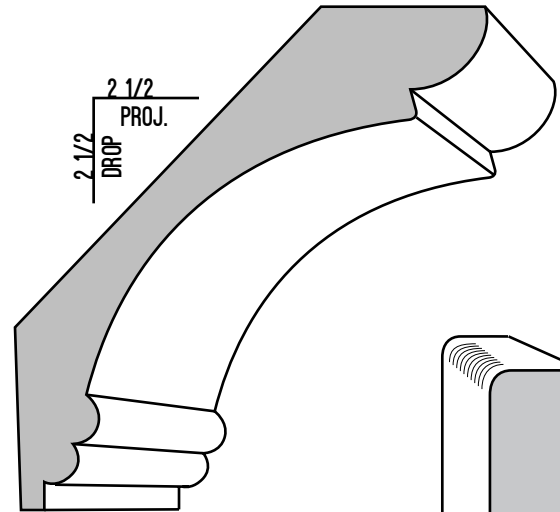

CROWN F611 - 3/4" X 3 5/8"

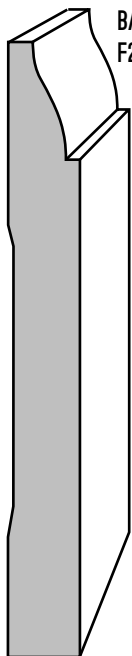

BASE
F217-3/8" X 3 1/4"

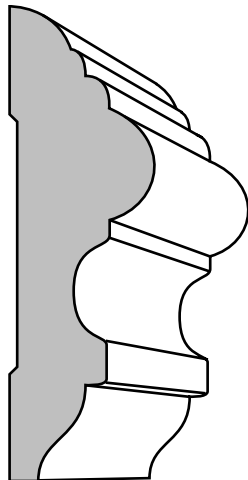

CHAIRRAIL F719
3/4" X 2 1/2"

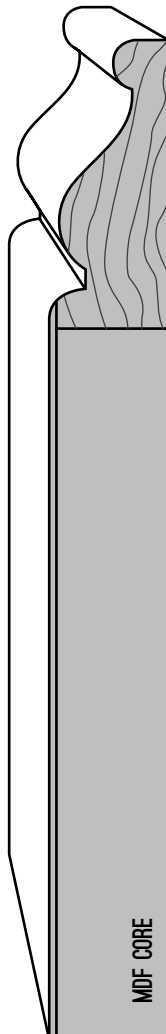

BASE F280
5/8" X 5 1/4"

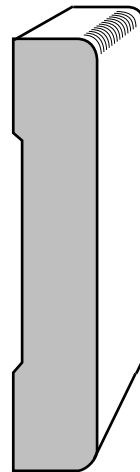

CHAIRRAIL F156 - 7/16" X 2 1/4"

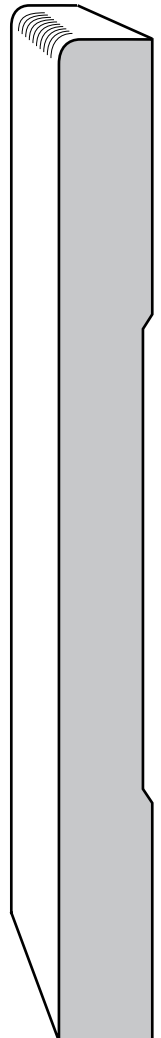

BASE F293 - 1/2" X 5 1/4"

STANDARD SERIES

PREMIUM 1

PREMIUM 2

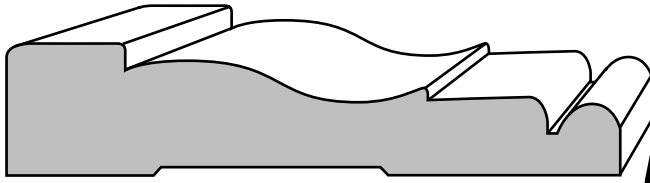

CASING F131 - 11/16" X 3 1/4"

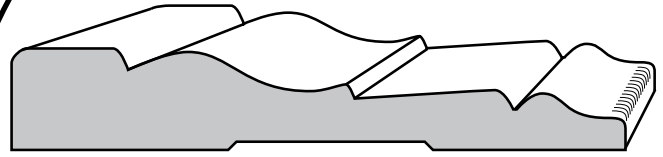

CASING F134 - 9/16" X 3 1/4"

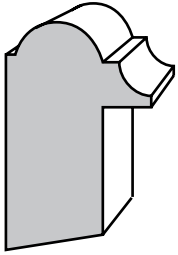

BACKBAND
F197 -
3/4" X
1 3/16"

2 11/16
PROJ.
3 1/4
DROP

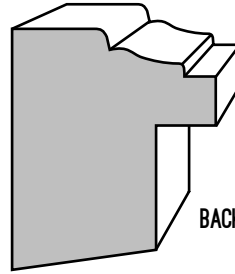

BACKBAND F196 - 1 1/4" X 1 1/16"

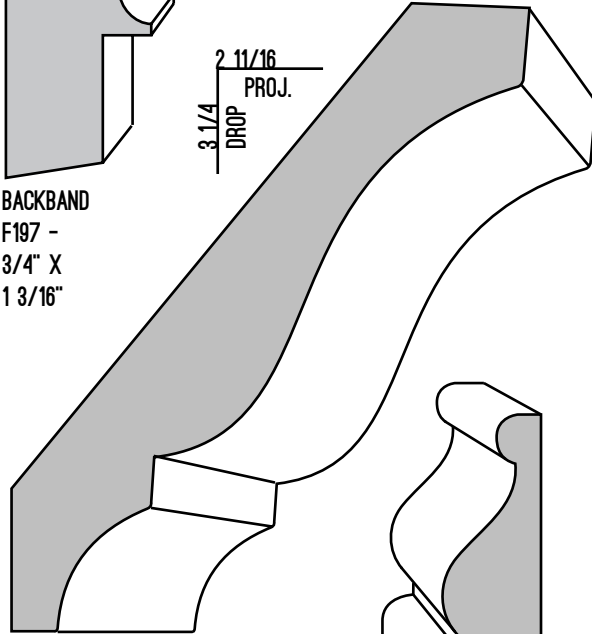

CROWN F614
11/16" X 4 1/4"

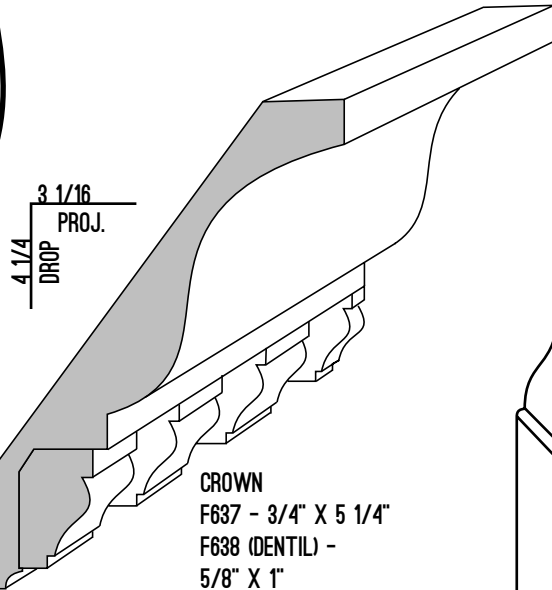

3 1/16
PROJ.
4 1/4
DROP

CROWN
F637 - 3/4" X 5 1/4"
F638 (DENTIL) -
5/8" X 1"

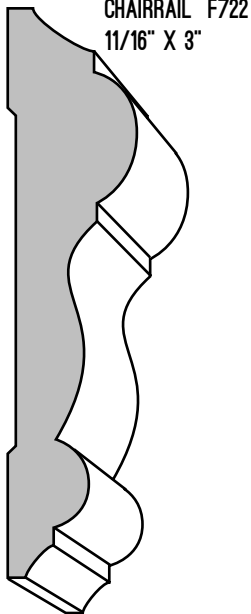

CHAIRRAIL F722
11/16" X 3"

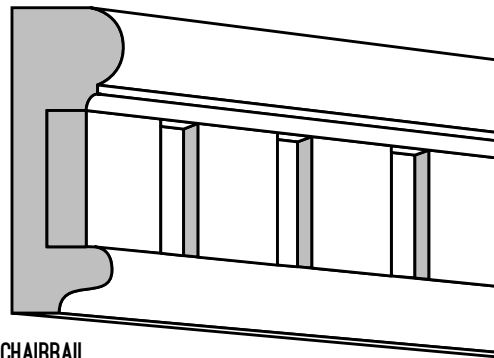

CHAIRRAIL
F734 - 11/16" X 2 1/4"
F735 (DENTIL) - 9/32" X 1"

BASE F2800
9/16" X 5 1/4"

BASE F225 - 7/16" X 4 1/4"

STANDARD SERIES

RUSTIC

CROWN F6514
7/8" X 4 1/4"

CHAIR RAIL F7514
9/16" X 2 1/4"

CASING F1514
1 1/16" X 3 1/4"

BASE F2514
9/16" X 5 1/4"

CROWN EXTENDER F1515
9/16" X 3 1/4"

VICTORIAN

CROWN F6624
3/4" X 5 1/4"

BASE F2624
9/16" X 5 1/4"

CASING F1624
1 1/16" X 3 1/4"

CHAIR RAIL F7624
9/16" X 2 1/4"

Architectural SERIES

ARTS & CRAFTS

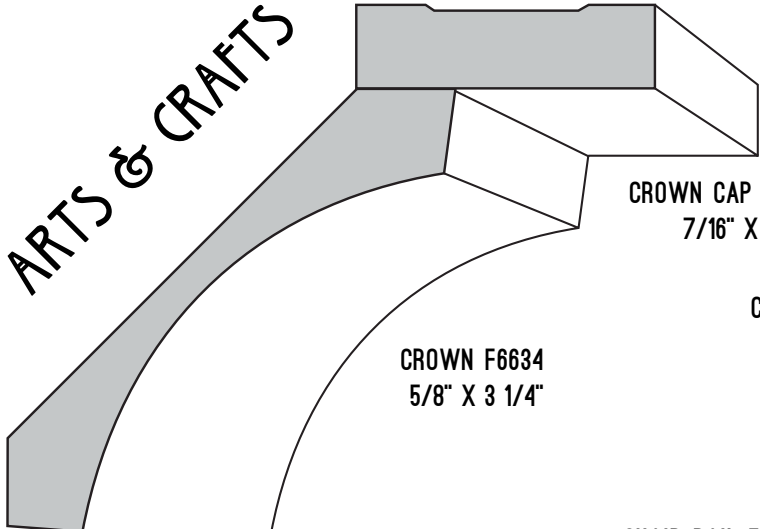

CROWN F6634
5/8" X 3 1/4"

CROWN CAP F1637
7/16" X 1 1/2"

CHAIR RAIL CAP F1636
1/4" X 11/16"

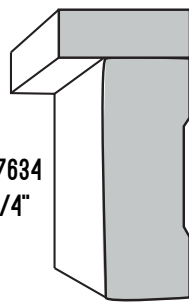

CHAIR RAIL F7634
7/16" X 1 1/4"

CASING BAND F1636
1/4" X 11/16"

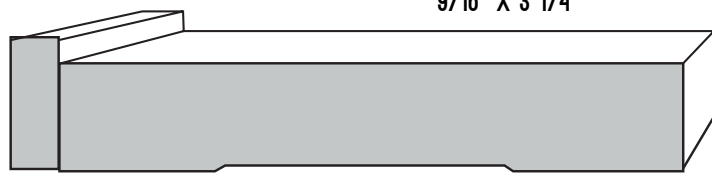

CASING F1634
9/16" X 3 1/4"

BASE CAP F1636
1/4" X 11/16"

BASE F2634
9/16" X 2 1/4"

BASE CAP F1636
1/4" X 11/16"

BASE F1634
9/16" X 3 1/4"

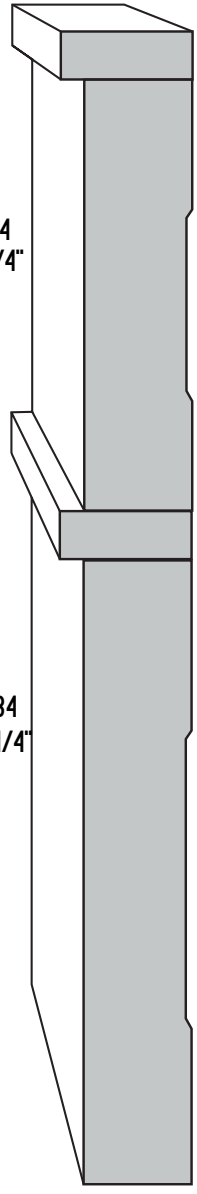

Architectural SERIES

SOUTHWESTERN

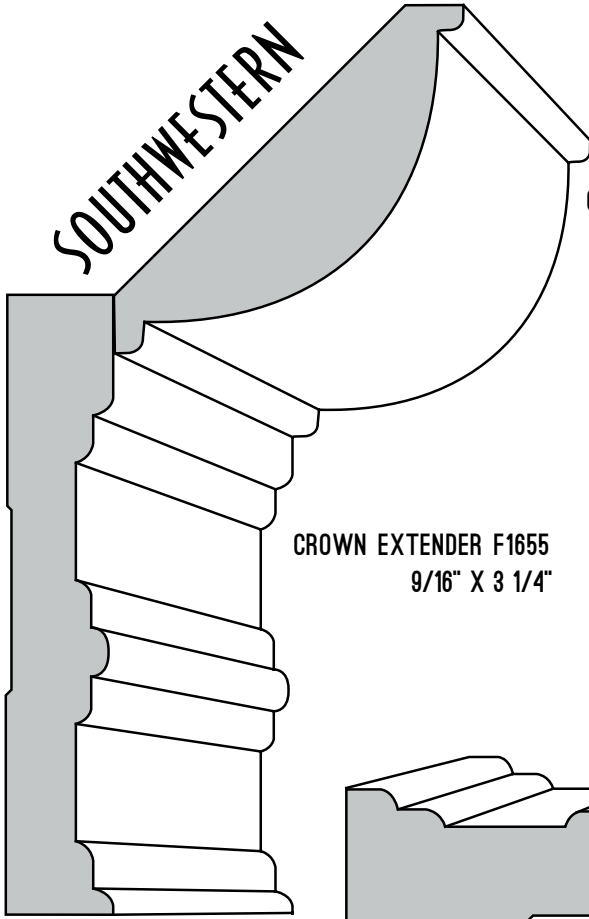

CROWN F6654
3/4" X 2 1/4"

CHAIR RAIL F7654
7/16" X 2 1/4"

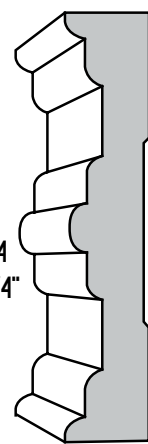

CROWN EXTENDER F1655
9/16" X 3 1/4"

CASING F1654
11/16" X 3 1/4"

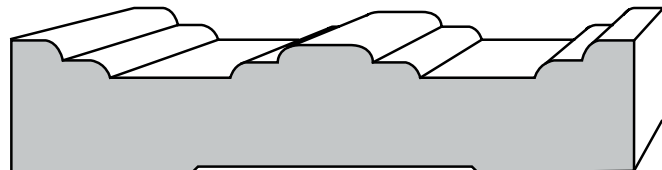

BASE F2654
9/16" X 5 1/4"

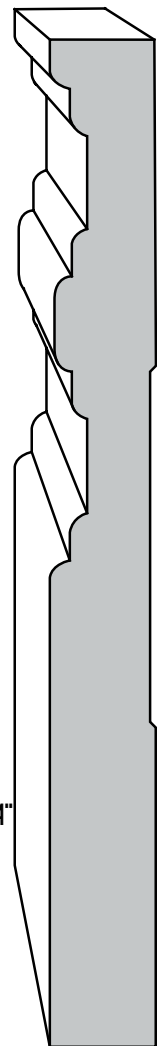

ART DECO

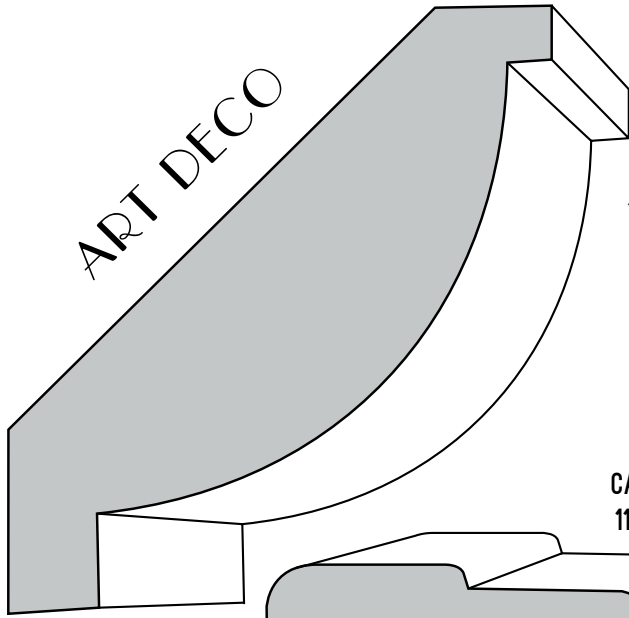

CROWN F6614
1 3/16" X 4 1/4"

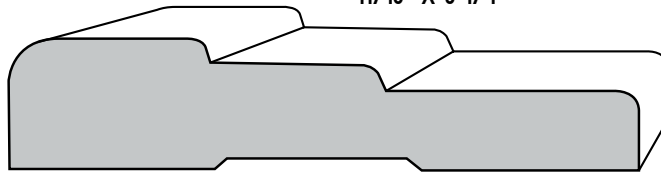

CASING F1614
11/16" X 3 1/4"

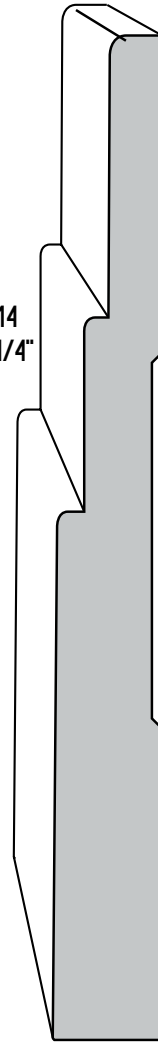

BASE F2614
9/16" X 5 1/4"

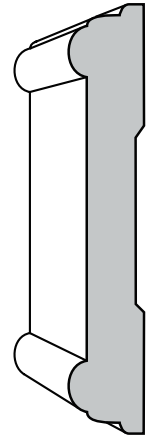

CHAIR RAIL F7614
3/8" X 2 1/4"

MODERN

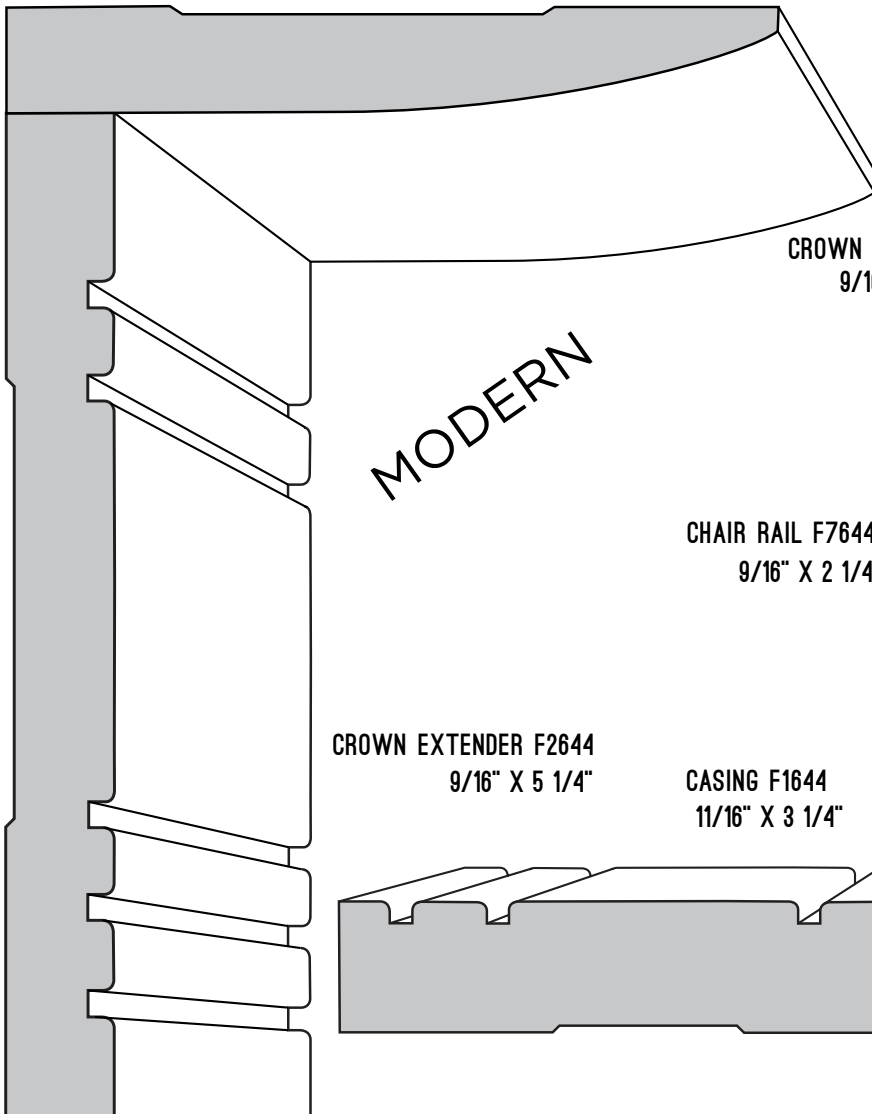

CROWN EXTENDER F2644
9/16" X 5 1/4"

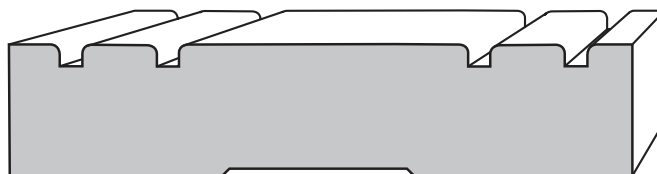

CASING F1644
11/16" X 3 1/4"

CROWN F6644
9/16" X 4"

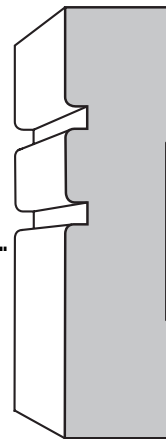

CHAIR RAIL F7644
9/16" X 2 1/4"

BASE F2644
9/16" X 5 1/4"

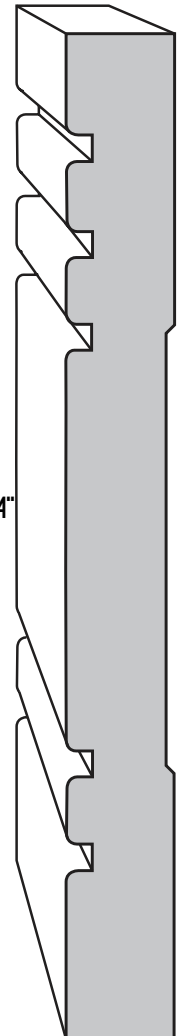

DOOR & WINDOW TOPPERS

Toppers can be obtained in any species or mix and match.

They are sized to your dimensions and fully assembled.

Use the suggested casing, backbands and base for the perfect Craftsman look.

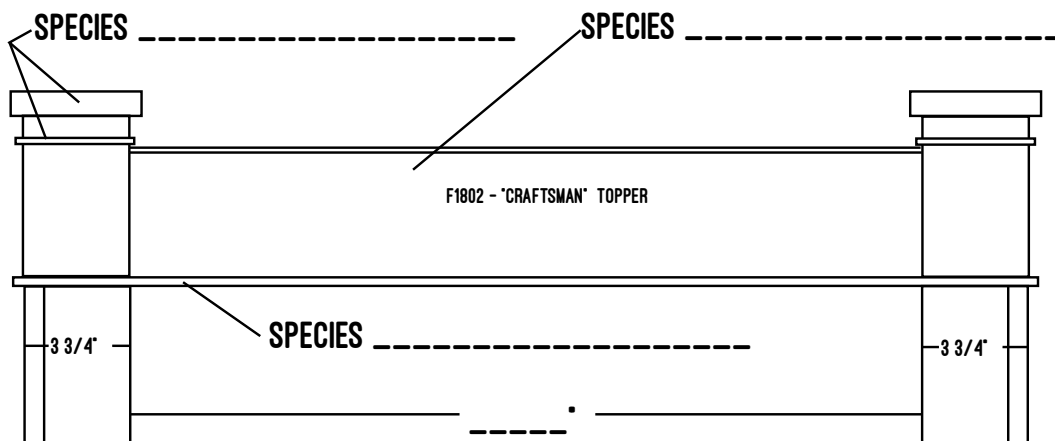
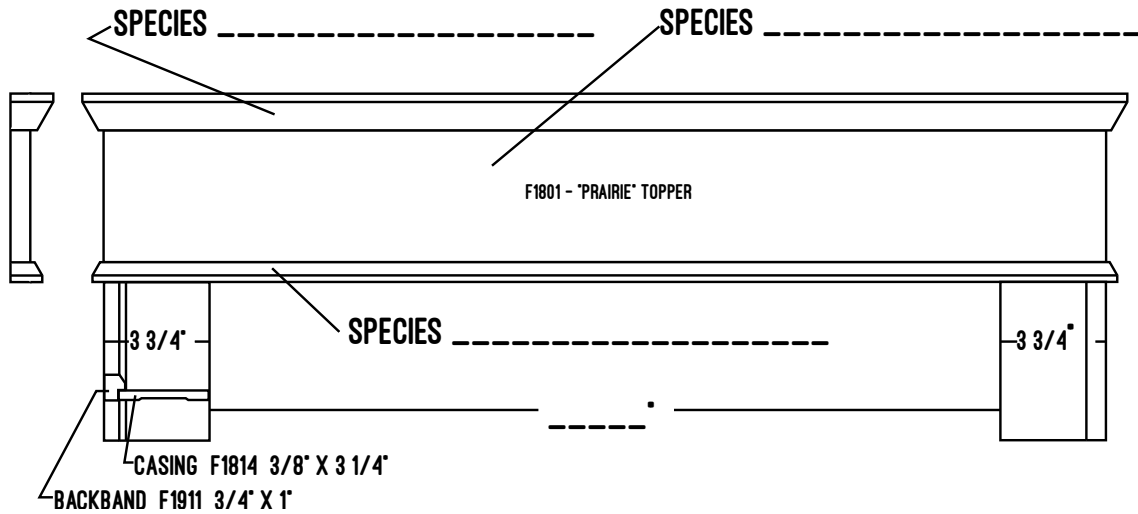
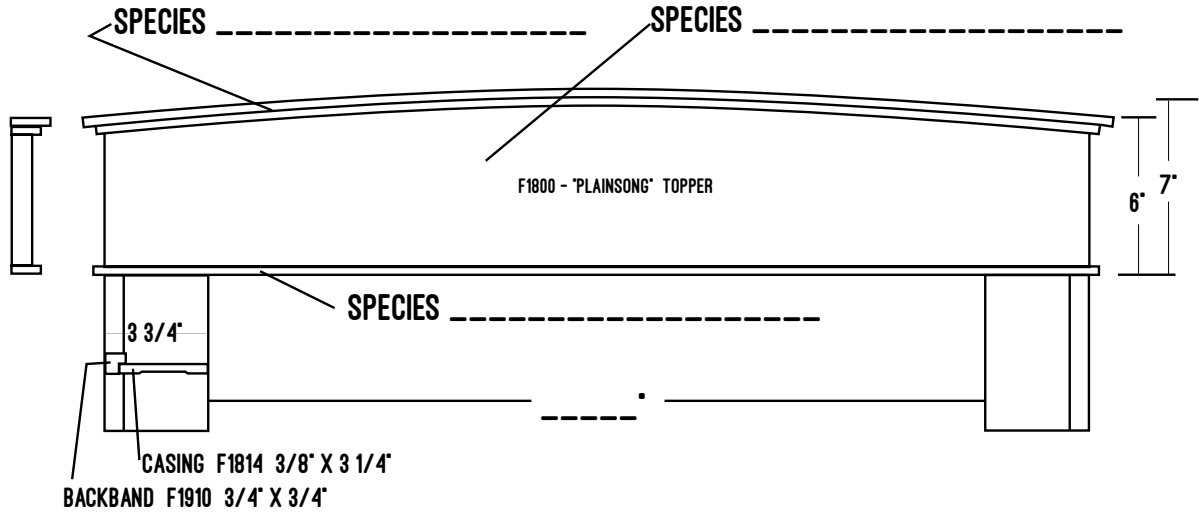

CRAFTSMAN COLLECTION MOULDINGS

These mouldings are designed to be a perfect complement to the Door & Window Toppers.

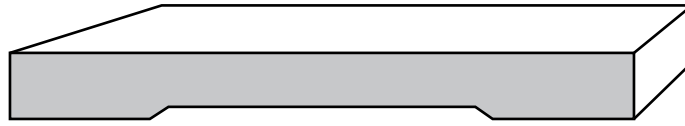

CASING F1814 3/8" X 3 1/4"

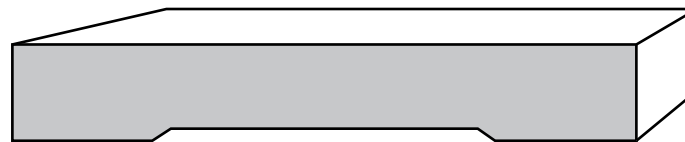

CASING F1815 1/2" X 3 1/4"

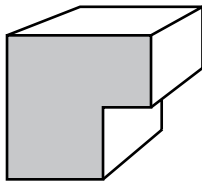

BACKBAND
F1910 3/4" X 3/4"
USE W/F1814

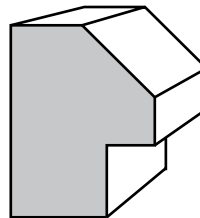

BACKBAND
F1911 3/4" X 1"
USE W/F1814

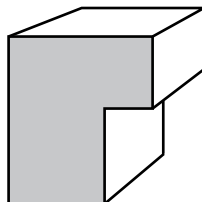

F1915 3/4" X 7/8"
USE W/F1815

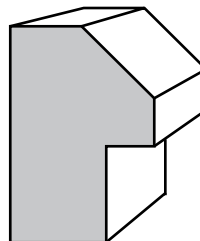

F1916 3/4" X 1 1/8"
USE W/F1815



BASE F293
1/2" X 5 1/4"

BUILT-UP MOULDINGS

BUILT-UP MOULDINGS

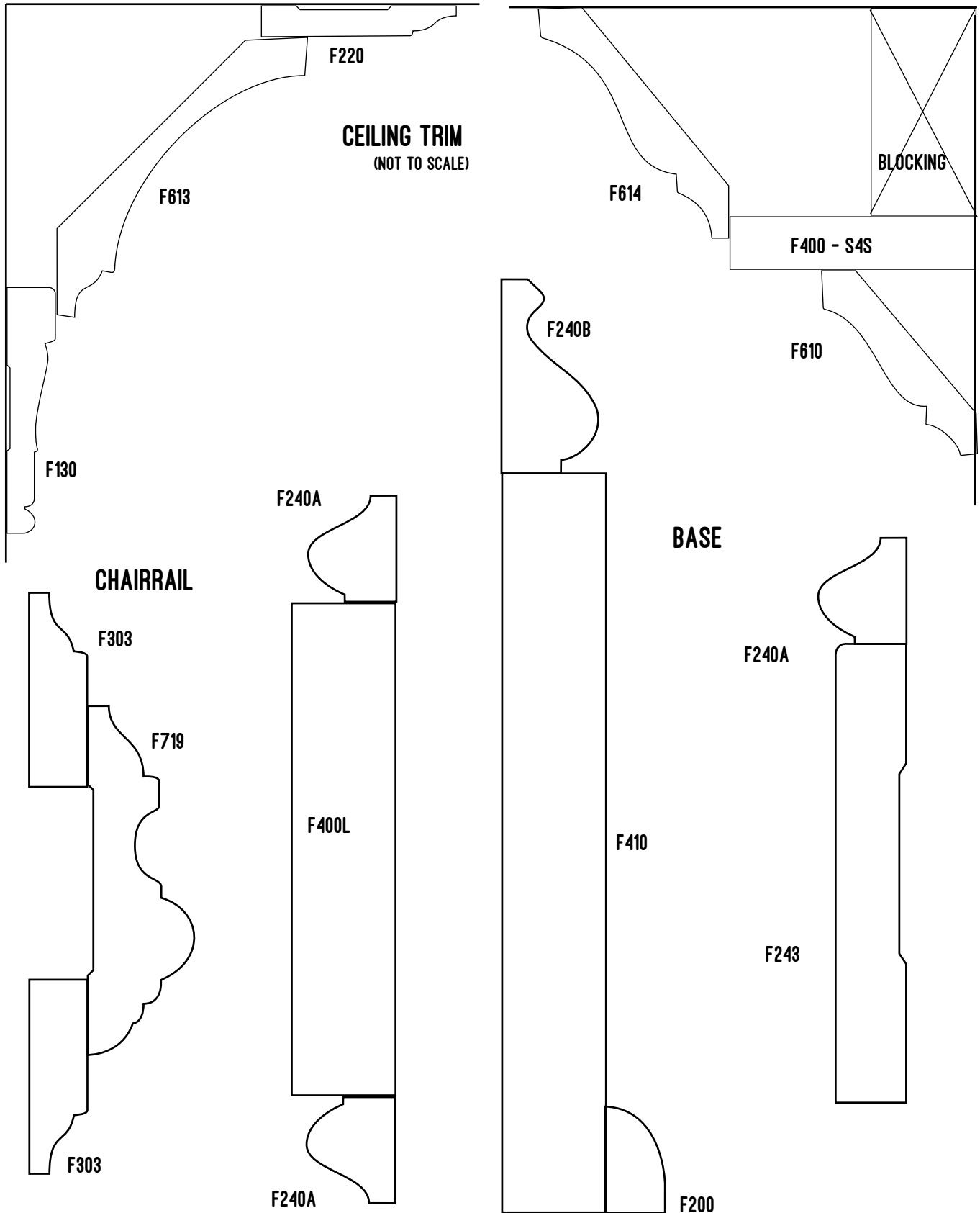

FIREPLACE MANTELS

THE ASHFORD - F1230

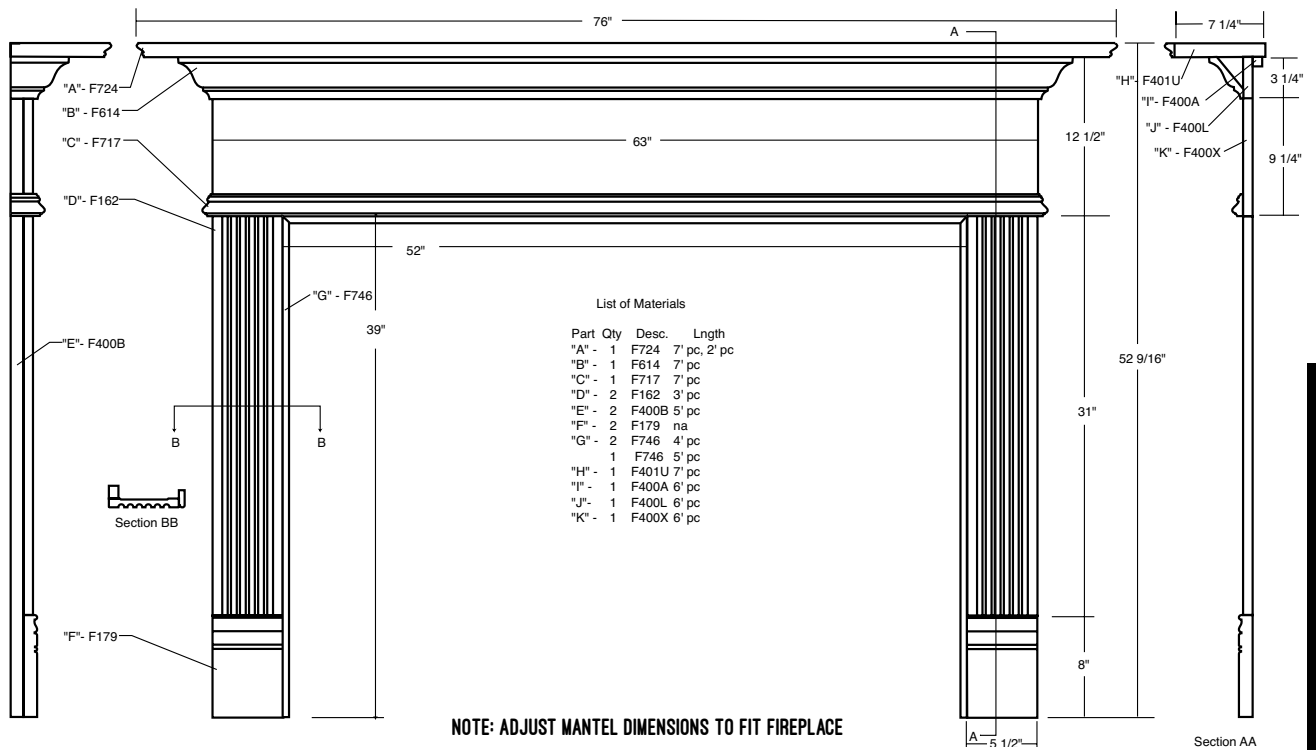

FIREPLACE MANTELS

THE BRADBURY - F1231

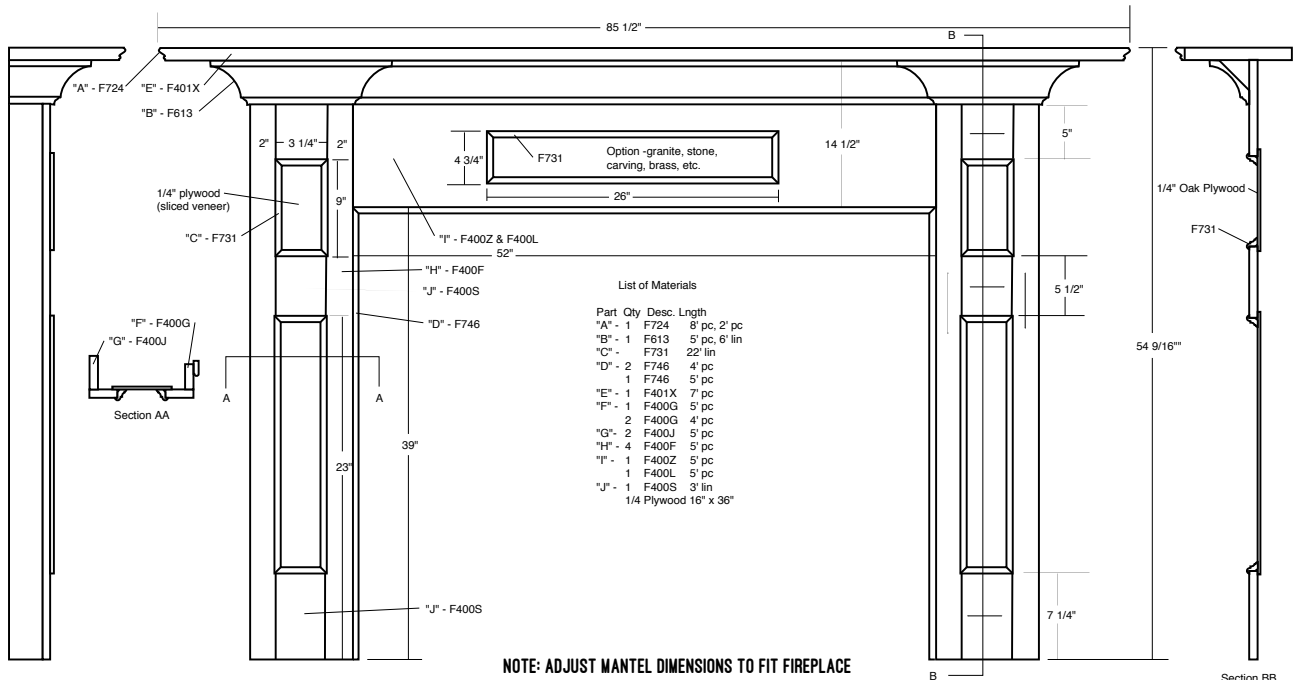

FIREPLACE MANTELS

THE KINGSTON - F1234

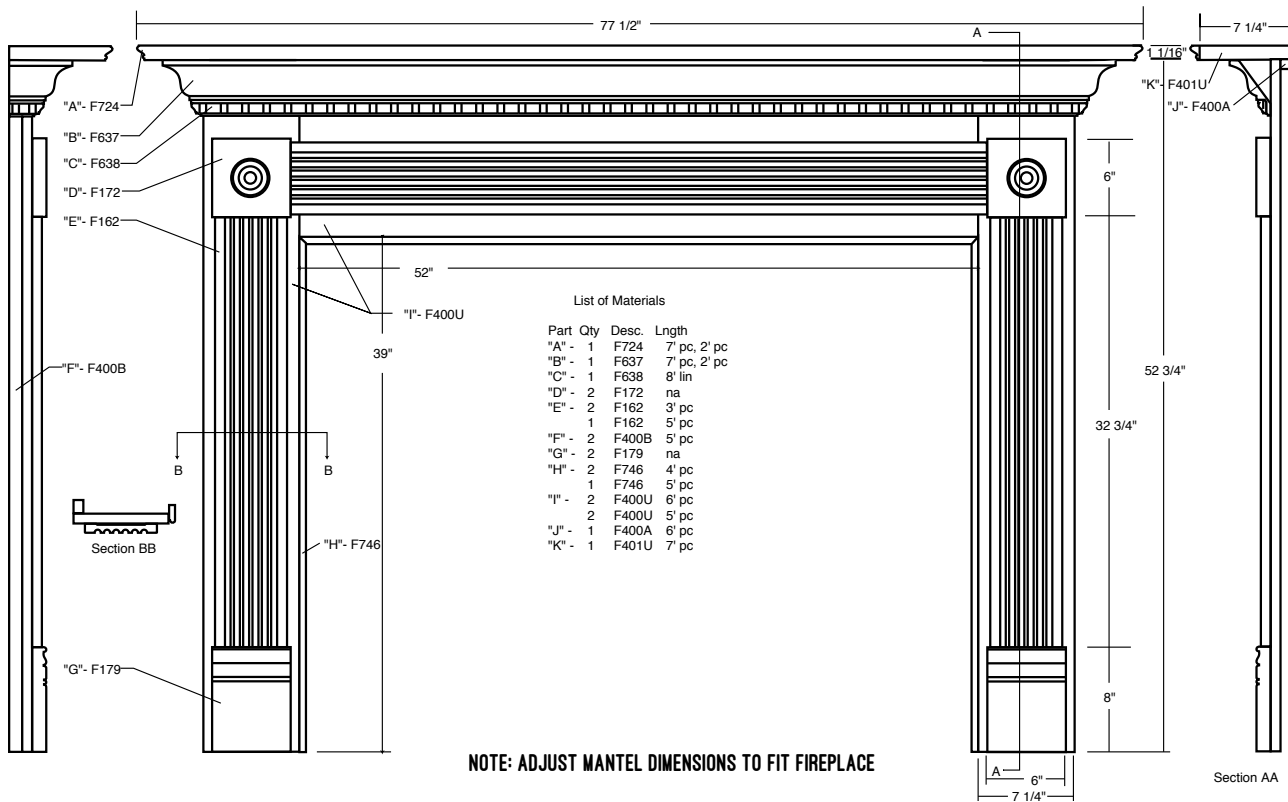

THE SPRINGFIELD - F1238

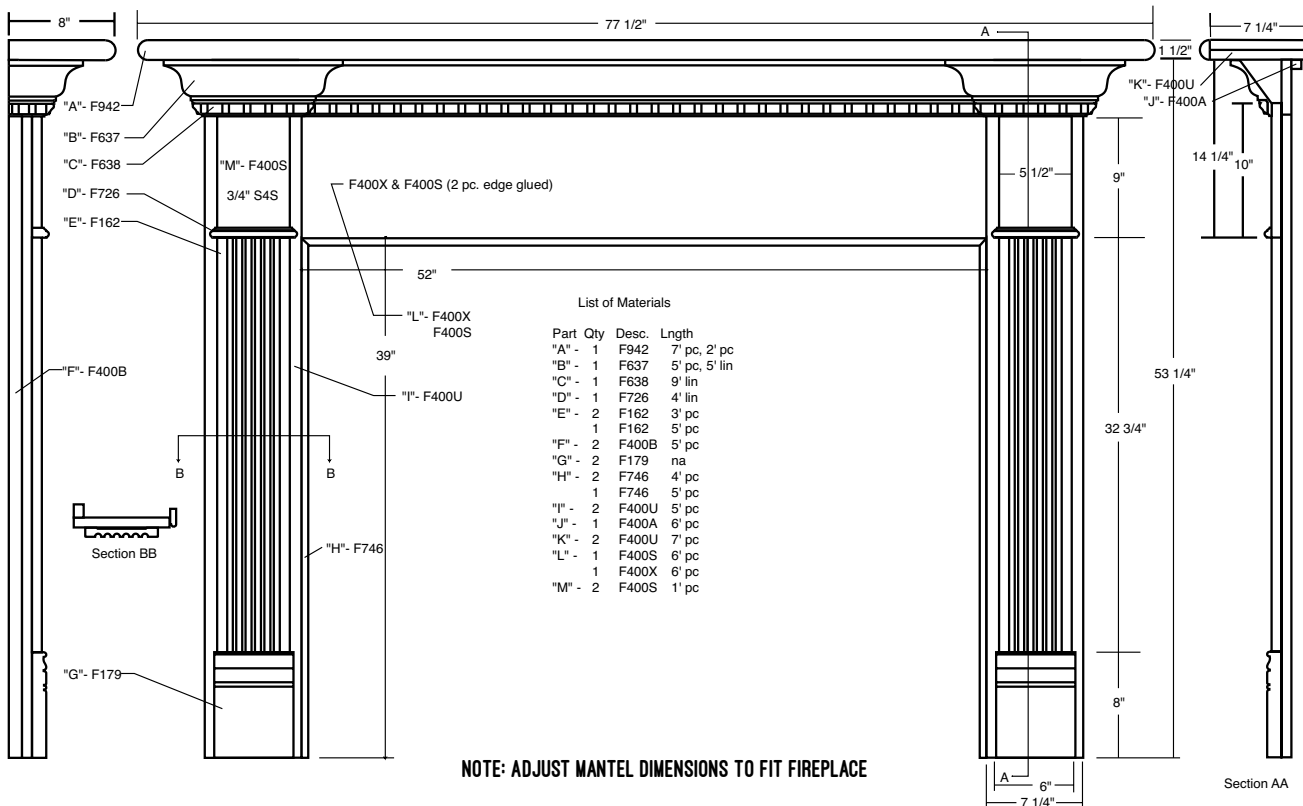

FIREPLACE MANTELS

THE GEORGETOWN - F1232

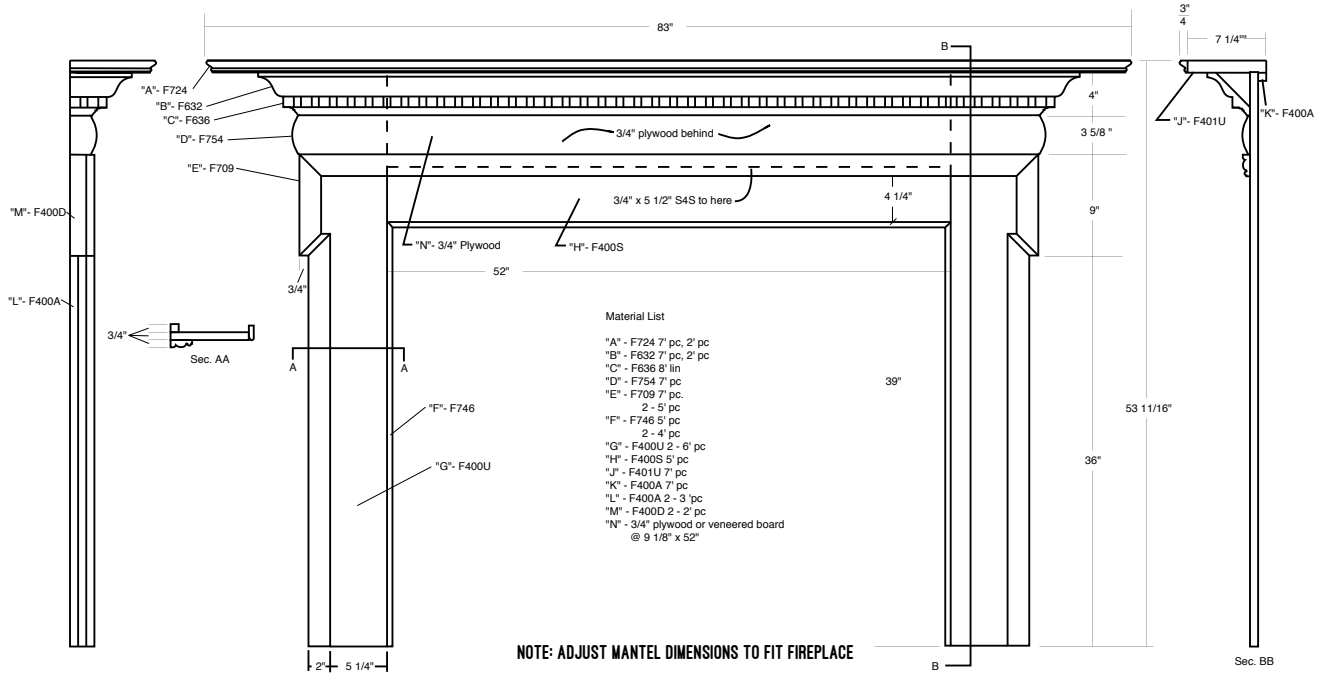

THE HAMPSHIRE - F1233

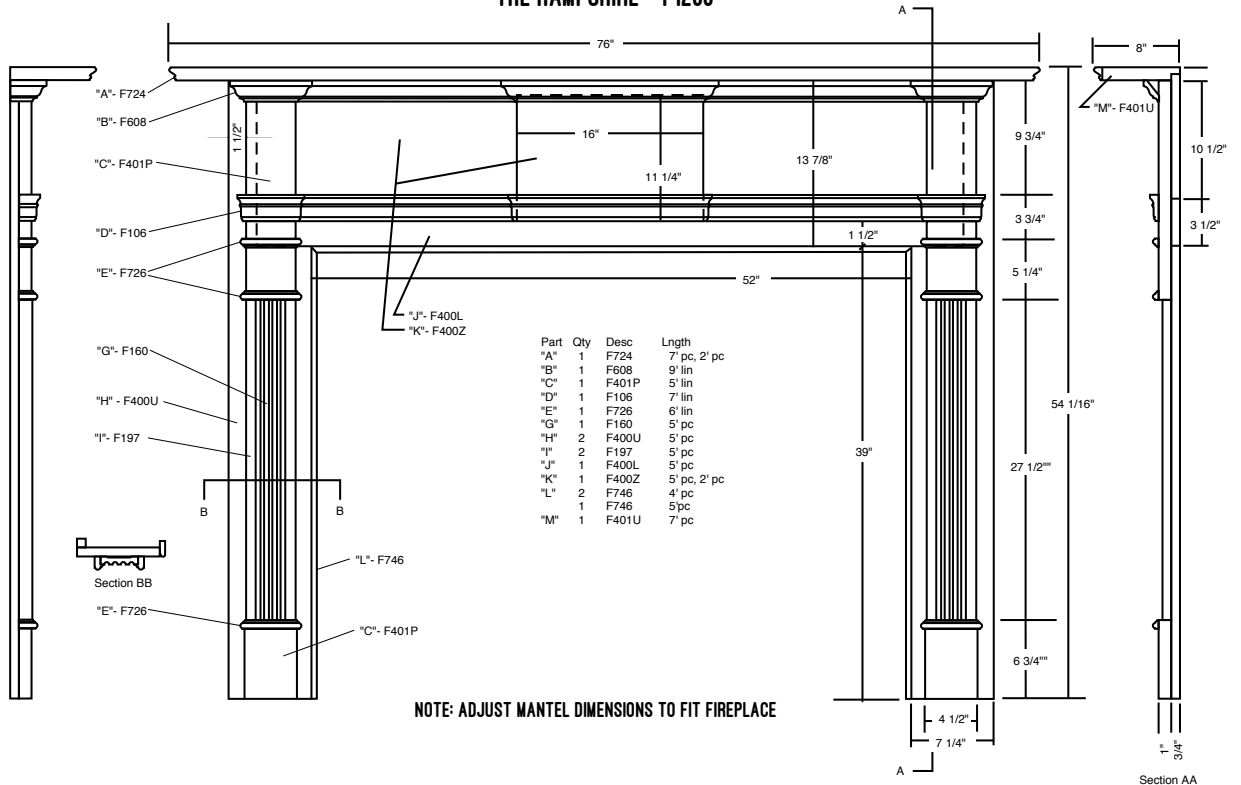

NOTES

NOTES

PLEASE VISIT FERCHE.COM FOR HELPFUL TOOLS & RESOURCES

Don't forget to check out our sanding policy to learn why sanding is the key to a quality finish.